

Holistic Industrial Water Management for Increased Productivity, Reliability & Sustainability

A different approach to water and fluid management yields different results.

Very different.

Your job is to run a productive plant, site, or mine. Xylem's is to look holistically at your industrial water and fluid management needs and change them from a necessary expense to a strategic advantage through innovation that reduces effort, energy and waste. We leverage four unique strengths to do it:

INDUSTRIAL WATER EXPERTS

With 170 years of experience, we've seen it, done it, and designed for it. So, you can trust our Industrial water and fluid management experts to help solve your most complex challenges with the right equipment and services, no matter the application.

BROAD PORTFOLIO

Your process requires dependable, high quality water and fluids. Our reliable, efficient water supply, pressure boosting, dewatering, industrial water management, heat transfer, treatment, wastewater and fire protection solutions ensure the fluids you rely on will always be ready to protect the environment, your assets and the bottom line.

SMART CONNECTIVITY

Our smart solutions ensure real-time monitoring and powerful data analytics for useful insights that remove guesswork and worry from your Industrial water and fluid management system, so it can run at peak efficiency all the time.

TRUE BUSINESS PARTNERS

We don't simply sell equipment and leave you to figure out what to do with it. We look at your challenges and devise ways to solve them with less effort and expense. That's the real benefit of working with Xylem.



Working with Xylem means working with unrivaled experts.

For more than 170 years, Xylem has led the way in pumping and related technologies, including water supply, pressure boosting, dewatering, industrial water management, heat transfer, treatment, wastewater and fire protection solutions. We've kept mission-critical operations running reliably in everything from nuclear power plants to navy ships to refineries and more. And we're ready to use our unmatched expertise to analyze, customize, engineer and install the optimal solution to help you get more from your water and fluid-management systems using the right combination of these great brands:

FLYGT

godwin 

 **LEOPOLD**

 **LOWARA**

mjk 

 **i-Analytical** 

pure
TECHNOLOGIES

SANITAIRE

SonTek

Standard **X**change

WEDECO

xylem

YSI

Everything you need for efficient water and fluid management

Business advantage comes from innovation, and here's one advantage that can lead to many others: partner with Xylem to discover how new combinations of water management technology and expertise can deliver the reliability, efficiency and safety you need while reducing operational and maintenance spend over the long term.



Solve Water Conservation

For open pit and underground mines, Xylem has everything to transport, treat and test water throughout exploration, development, operation and reclamation.



Solve Fluid Management

Whether water is scarce or plentiful, Xylem can help integrate your operations from sourcing to production to reuse in upstream, midstream and downstream applications - including product transport and pipeline integrity management.

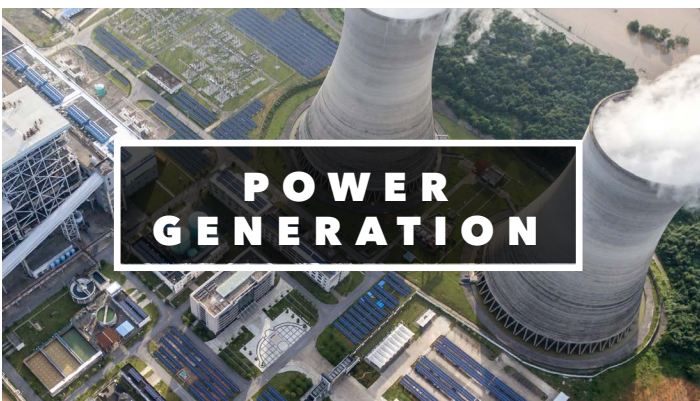

Solve Efficiency

Whether your source is fossil fuel, nuclear, geothermal, or hydro, Xylem provides all the support you need for raw water intake, cooling water, condensate, deaerator, boiler feed, auxiliary water, and wastewater applications.



Solve Biosecurity

From broodfish to market, our reliable, integrated solutions will help you control costs while making your operations healthier and sustainable at every stage of the production cycle.



METALS MANUFACTURING

Solve Reliability

The manufacturing of metals like steel and aluminum is water and energy intensive. With Xylem's fluid handling solutions for various applications in your metals plant, you can ensure that your process operates smoothly and reliably.



GENERAL MANUFACTURING

Solve Productivity

For water- and fluid management-intensive applications, Xylem pumps, heat exchangers, disinfection devices and monitoring & controls keep the focus on your product, not on your production process.



AGRICULTURE

Solve Scarcity

From water management for irrigation and greenhouses to manure handling and biogas, Xylem has pumps, mixers, water meters and smart solutions to maximize productivity in your farm.



WASTE MANAGEMENT

Solve Regulatory Compliance

The appropriate pumping and treatment of toxic and corrosive leachate and wastewater in landfills is crucial for the environment and adequate regulatory compliance. Xylem has the pumping and treatment solutions for your waste management needs.



FOOD & BEVERAGE

Solve Quality

Water is a crucial input for Food & Beverage customers to ensure the best quality of the end product and Xylem's water management solutions ensure the highest quality while reducing energy and waste.



PULP & PAPER

Solve Water Efficiency

Xylem's expertise in filtering, ozone dissolution, and water reuse help mills lower costs and reduce their reliance on potentially over-stressed sources of water.

Xylem delivers more value by mastering your entire use cycle.

Smarter industrial water and fluid management starts from our holistic view of the entire use cycle from intake to discharge. By thinking about every step as part of a process, instead of as a standalone function, we find ways to integrate the sourcing, treatment and reuse of fluids to increase productivity and profits.

**PIPELINE
CONDITION
ASSESSMENT**



**WATER
INTAKE**



**WATER
BOOSTING**



**WASTEWATER
TREATMENT & REUSE**



**STORM WATER /
FLOOD CONTROL**

**WATER CIRCULATION
& COOLING**

**HEAT
TRANSFER**

**ANALYTICS
& METERING**



**FIRE
PROTECTION**

**PROCESS
WATER**

Solutions Deep Dive

WATER INTAKE

<u>Column Pumps & Hydroturbines</u>	10
<u>Submersible Wet & Dry Installed Pumps</u>	11
<u>Borehole Pumps</u>	12
<u>Vertical Turbine Pumps</u>	13

HEAT EXCHANGERS

<u>Heat Transfer Equipment</u>	21
--------------------------------------	----

PROCESS WATER

<u>Single Stage Pumps</u>	14
<u>Multistage Pumps</u>	15
<u>Booster Packages</u>	16
<u>Circulation Pumps</u>	17
<u>Smart Pump Range</u>	18
<u>Optymyze</u>	19
<u>Specialty Pumps</u>	20

WASTEWATER PUMPING & DRAINAGE

WASTEWATER PUMPING

<u>Submersible Stainless Steel Wastewater Pumps</u>	22
<u>Flygt Concertor</u>	23

WATER DRAINAGE

<u>Drainage Pumps</u>	24
<u>Flygt Bibo Alpha</u>	25
<u>Self-priming pumps</u>	26

**DISINFECTION &
WASTEWATER TREATMENT**

UV Disinfection Systems 30

Ozone Disinfection Systems..... 31

Mixers 32

Wastewater Aeration 33

**DIGITAL SOLUTIONS,
SERVICES & RENTAL**

Digital Solutions..... 38

Service & Rental..... 39

ENGINEERED SOLUTIONS

Custom Pumps..... 28

Packaged Pump
Stations and Engineered
Pumping Solutions 29

**ANALYTICS, METERING
& PIPELINE ASSESSMENT**

Analysis through the
Industrial Supply Chain 34

Pipeline Condition
Assessment Services 35

Industrial Water Meters..... 36

Industrial Thermal
Energy Meters 37

Column Pumps & Hydro Turbines

P7000, L3001



Advantages

- Modular, slimline compact design
- Quick and easy installation
- Low maintenance owing to Flygt's self-cleaning and clogging-free N technology
- Robust and durable
- Wide range of Monitoring and Control options including remote capabilities

Applications

- Raw water intake
- Transfer of sludge and effluent in large volumes of low height
- Cooling water
- Flooding
- Outlet effluent from water treatment plants
- Aquaculture, fish farming
- Water parks and leisure parks
- Olympic white-water courses



L3400
Mixed flow pump for column installations



P7030
Slimline propeller pump

Opting for Flygt propeller pumps allows you to reduce your construction and installation costs by 50%



Usable in applications with heads up to 20 meters (65 ft) and flows up to 10 m³/s per unit, a wide variety of site conditions can be accommodated by our family of turbines.

EL 7585
Flygt submersible hydro-turbine



AC-series, Large vertical column pump

Model	Power (kW)	Height max. (m)	Flow max. (l/s)
P7000	6.0 - 500	11	6000
L3001	55- 400	20	2200
Hydro turbines	40- 800	20	12000
AC-series, Large vertical	>500*	175*	25000*

*customization according to customer need and available power supply

Submersible Wet & Dry Installed Pumps

3000 Series



Advantages

- Superior non-clog performance with chopper, grinder and vortex impellers
- Self-cleaning non-clog impellers with N-technology as well as cutting edge action for the toughest challenges
- Hardened cast iron for all types of pumps. Optional Duplex stainless steel and Hard-Iron impellers for N and Chopper pumps.
- Multi-vane designs for the highest wastewater efficiency
- Sustained high efficiency and maximum reliability
- Many different options for voltage, cabling, paint, etc.
- Modular construction
- Low maintenance
- Available for wet P and S as well as dry, T and Z, installations
- Wide range of Monitoring and Control options including remote capabilities

Applications

- Wastewater and contaminated water
- Cooling water
- Recirculation of sludge
- Industrial effluent
- Rainwater collection
- Transfer of process water
- Amusement parks, water rides, surfing machines

Flygt's solution for vertical dry installations.
Quick and easy to install.



Height-adjustable and rotatable cast-iron stand for dry vertically installed pumps (10-100kW)



Monitoring and Control options with remote capabilities



Patented service inlet and service cart/sled for horizontally dry installed medium to high-capacity pumps

Model	Power (kW)	Max. height (m)	Flow max. (l/s)	Hydraulic
N 3000	2-310	100	900	Anti-clogging N impeller

Borehole Pumps

e-GS, Scuba, Z6, Z8, Z10, Z12



Advantages

- Compliant with ErP 2015
- Dynamic wear ring (only Z8-10-12)
- Highly resistant to use and abrasion
- Resistant to corrosion
- Available in Duplex stainless steel (only Z8-10-12)
- A choice between oil or water tank motors
- Easy to maintain
- Durable
- Horizontal or vertical operation

Applications

- Water supply
- Irrigation
- Pressurized systems
- Lowering of the water table
- Fire prevention



Scuba



Z8



Cooling jackets



Z6

Model	Size of borehole	Power max kW	Height Max. m	Max. flow m ³ /h
e-GS	4"	7.5	340	21
Scuba	5"	2.2	100	11.5
Z 6	6"	55	700	78
Z8	8"	150	550	180
Z10	10"	300	545	350
Z12	12"	350	450	520

Vertical Turbine Pumps

Lineshaft (VIT/ DWT), Canned (VIC) and Submersible (VIS)



A century of experience in vertical turbine pumps that maximize uptime, efficiency and flexibility. Xylem's Goulds Water Technology brand offers vertical turbine models for every application, while utilizing common hydraulic designs for the pump bowl assembly. The vertical turbine can be multi-staged, for tremendous flexibility in pump selection and future system changes.

Advantages

- Customizable configurations for site-specific needs
- Application-specific product options and material choices
- Industry-leading efficiencies
- Minimal floor space requirements
- Options for low-NPSHa conditions and suction lift concerns

Applications

- Municipal
- power
- Industrial
- Agricultural

Driver options

- Electrical motors in Vertical Solid Shaft (VSS) or Vertical Hollow Shaft (VHS) construction
- RAGDs for engine-driven configurations

Special coatings

- TNEMEC
- Scotchkote
- Carboline
- Other NSF certified coating available on request

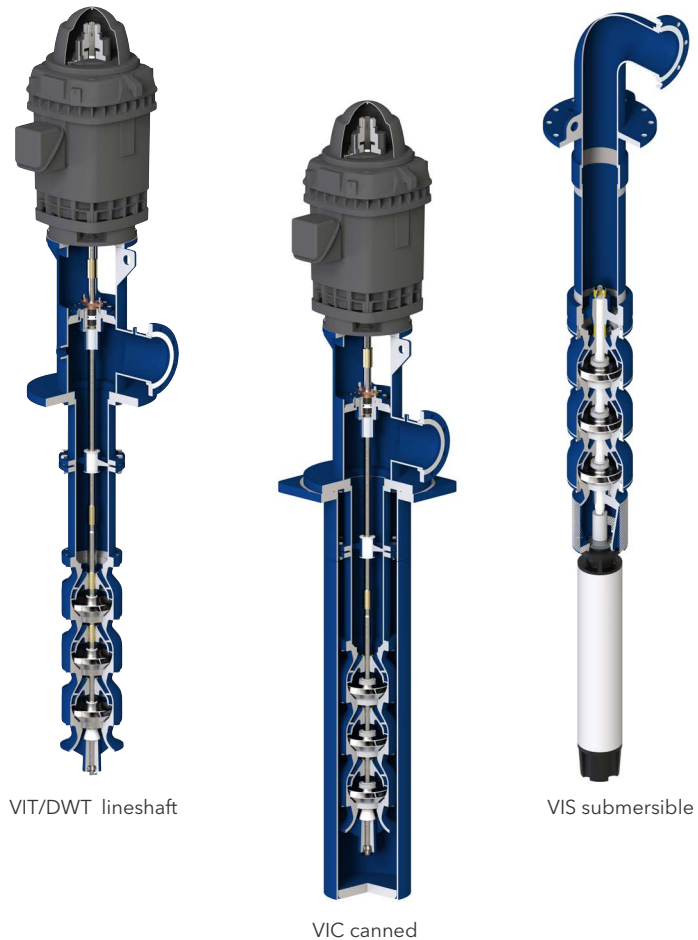

VIT/DWT lineshaft

VIC canned

VIS submersible

	PUMP SIZE	CAPACITY	HEAD
VIT/DWT	125 to 1,200 mm	11 to 11,500 m ³ /h	up to 120 m per stage
VIC	125 to 1,200 mm	11 to 11,500 m ³ /h	up to 120 m per stage
VIS	125 to 500 mm	11 to 1,800 m ³ /h	up to 120 m per stage

Single Stage Pumps

e-NSC, LS, e-IXP, e-XC, e-SH, SHO, CO,CEA



Advantages

- High output
- Compliant with the ErP 2015 standard
- Compact design (extended shaft versions)
- Easy to maintain owing to its Back-Pull-Out design
- Sturdy construction
- Highly versatile owing to a wide selection of materials - the best solution, irrespective of the liquid pumped
- Speed variation option with Hydrovar
- Option for IE4 motors
- ACS certification for e-NSC, e-SH and CEA pumps

Applications

- Industrial Fluid transfer
- Sea water and brackish water transport
- RO
- Filtration
- Boiler feed
- Power application
- Chemical applications
- Water supply
- Transfer of returned hot water
- Heating and Cooling system
- Fire prevention

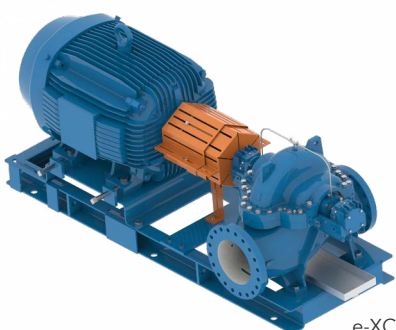

e-XC
Single Stage, Double Suction
Centrifugal Pumps

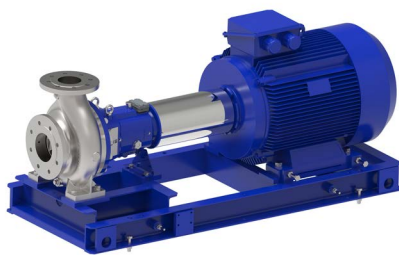

e-IXP
Single unit pump designed
according to ISO2858 and
ISO5199, available in different
materials and constructions



e-NSC
Single-stage pumps
EN733 standardized



SHO
Stainless steel
pumps with open
impellers

Model	Flow max. m ³ /h	Max. height m	Range of temperature, °C
SHO	56	50	-10°C to 120°C
CO	54	24	-10°C to 110°C
CEA(N)	31	30	-10°C to 110°C
e-SH	240 (2 poles) 144 (4 poles)	110 (2 poles) 27 (4 poles)	-30°C to +120°C
e-NSC	640 (2 poles) 1,800 (4 poles)	160 (2 poles) 100 (4 poles)	-40°C to +160°C
e-IXP	1100	160	up to 180°C
LS	5,400	175	up to 180°C
LC (PN25)	3,800	140	
LCP (PN25)	3.800	80	up to 210°C
e-XC	12.000	250	-18 to 120°C



e-SH
Standardized centrifugal pumps
EN 733 with Hydrovar variator



CO/CEA-CEAN
Stainless steel single unit centrifugal
pumps with open (CO) or closed (CEA)
impellers

Multistage Pumps

e-SV, e-MP, e-SVI and e-HM



Advantages

- Impellers available in different materials (stainless steel, bronze, cast iron) for corrosive liquids
- High output
- Energy efficient and reliable
- Easy to maintain
- Tandem pumps up to 40 bar (e-SV)
- Speed variation option with Hydrovar or smart pump version
- Option for IE4 motors
- ACS certification

Applications

- Water supply
- Water circulation
- Pressurized systems
- High-pressure washing
- Cooling cycles
- Transfer of process water
- Water supply into industrial boilers
- Lubrication of machine tools



e-SV
Fabricated
Multi-stage
vertical pumps



e-MPA/ R/ D
Casted Multi-stage horizontal pumps



e-MPV
Casted Multi-stage
Vertical pumps



e-SVI
Vertical multi-stage with
submersible hydraulic unit



e-HM
Horizontal multi-stage

Model	Max. flow m ³ /h	Height max. m	Temperature range °C
e-SV	160	330	-30°C up to +180°C
e-HM	29	160	-10°C up to +120°C
e-SVI	120	250	-30°C up to +120°C
e-MPV	850	630	-25°C up to +140°C
e-MPA/ R/ D	850	950	-25°C up to +180°C
PVa	850	300	up to +140°C
P/ MP300	1800	300	up to +140°C

Booster Packages

GHV, GS, SMB, GXS, GMD

Advantages

- Complete range: Fixed and variable speed units, also with Hydrovar frequency converters
- Easy installation
- Redundant design for the maximum reliability
- High efficiency for energy and money saving
- Multi-pump operation
- Potable water certification

Applications

- Water pressurization
- Water distribution
- Water transfer
- Fire protection



Fast Lane
Ready on stock booster sets



GHV with e-SV



SMB with e-HME

Booster set Series	Number of Pumps (upto)	Type of pumps	Speed	Phases	Max. flow m ³ /h	Max Head m	Max Power kW
GHV	4 (up to 8 on request)	e-SV, e-HM	variable	1,3	640	140	8 x 22
GS	3	e-SV	fixed	3	630	160	3 x 55
SMB	3	e-SV, e-HM, VM	variable	1,3	90	160	3 x 2,2
GXS/GMD	2	e-SV, e-HM, CEA, BG	fixed	1,3	62	260	2 x 4

Circulation Pumps

For heating networks or domestic hot water



Circulation pumps for industrial buildings

Ecocirc XL advantages

- Speed and immediate pressure reading
- Dry run detection
- Analog input (0-10V / 4-20mA)
- Digital input (external start / stop)
- Digital output (signal relay)
- Insulation shell as standard on single head version

Ecocirc XL plus advantages

- Integrated BMS communication (Modbus RTU, BACnet BTL)
- Temperature probe input (differential temperature control)
- Ethernet cable
- Wireless connectivity (module as option)
- Automatic switching for double version



ecocirc XL single version circulator



ecocirc XL twin version circulator



e-LNEH
Single version in-line pump
with Hydrovar variator



e-LNT
Double version
in-line pump

Single or double centrifugal in-line pumps

e-LNE (single) and e-LNT (double) advantages

- Energy efficiency higher than the requirements of ErP standards, high output IE3 motors for the entire range.
- Option for IE4 motors
- Speed variation option with Hydrovar
- ACS certification for the entire range

Applications

- Heat transfer
- Heating and air conditioning of buildings
- Water supply to boilers
- Domestic hot water cycles

Smart Pump Range

Permanent magnet motors with embedded drive and high-efficiency hydraulics



The Lowara Smart Pump range incorporates state-of-the-art technology to optimize performance, communicate with other building systems and help you achieve your goals. Choose preprogrammed packages for easy, cost-effective installation – and benefit from this system's power, intelligence and performance.

Applications

- Residential
- Light industrial
- HVAC
- Booster set
- OEM

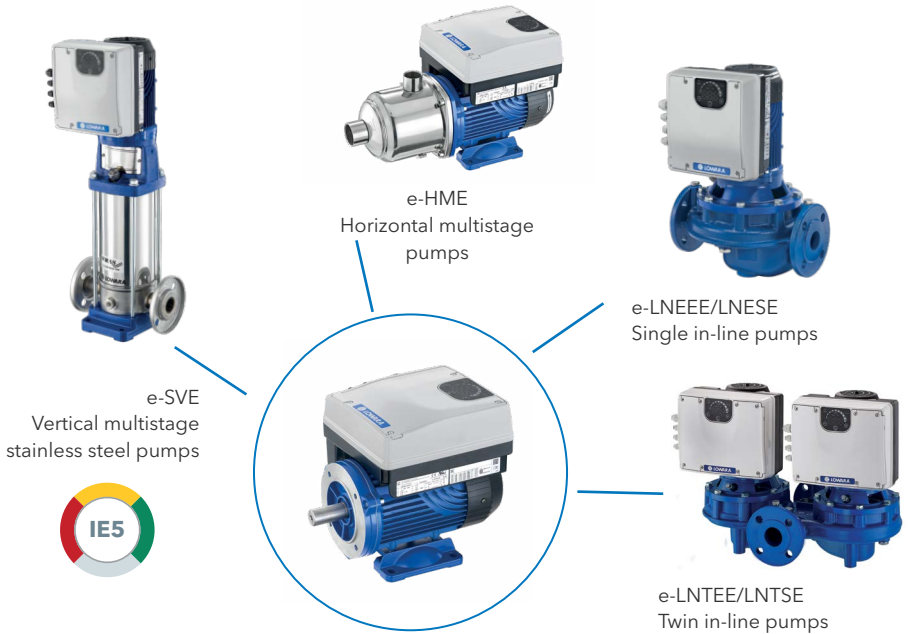

Specifications

Voltage: single phase 230 V - three phase 400 V

IES2 package with IE5 motors

Power: up to 2.2 kW

Enclosure rate: IP55

Multipump capability: up to 3 units

Ambient temperature: -20°C / +50°C full power

Power supply: 50/60 Hz

EMC: single phase C1 - three phase C2 category compliant EN 61800-3

Comms: BACnet and Modbus standard in single pumps

Harmonics: compliant with IEC/EN 61000-3-2



Variable Speed Hydrovar

5th Generation Hydrovar Intelligent Control System. Accurately adapts to systems demands and helps end-users to reduce costs and energy Savings while achieving optimum system Performance. Motor or wall mounted, it covers from 1.1 to 22 kW power size.

The optimize™ modular condition monitoring solution provides health guidance and predictive maintenance advice for rotating and fixed assets such as pumps, motors, heat exchangers and steam traps. It periodically monitors system vibration and temperature and allows everyday users to access simple-to-use monitoring tools from iOS or Android mobile devices.

Using predictive analysis, optimize identifies potential problems with your equipment before they occur, to help you manage system reliability and maintenance. Information is monitored, collected, stored and analyzed in the optimize sensor. This allows you to understand the current health and historical trends of your assets, create maintenance reminders and generate detailed reports. As a result, you can perform preventative maintenance before issues become critical to uptime.

Benefits

- Predictive maintenance to monitor the health of mechanical and electrical assets
- Asset management including asset location, size and manufacturing date
- System transparency to optimize reliability
- Optimized reporting that helps to simplify documentation, manage system maintenance and inform purchasing
- The ability to automatically share data with multiple local users
- Conveniently monitor system conditions on our simple-to-use mobile application

Industries

- Commercial Building Services
- Manufacturing
- Agriculture
- Water Utilities

Industries

- Monitoring the vibration of pumps and motors
- Monitoring the temperature of pump bearings
- Monitoring the temperature of motors to prevent overheating and winding damage
- Monitoring the performance of heat exchangers
- And more

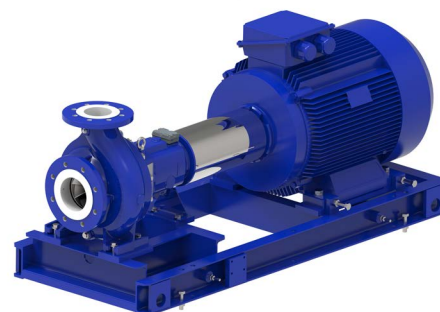

Specialty Pumps



Through Xylem's Jabsco and Flojet brands and a wide range of pump technologies - including air operated diaphragm, motor driven diaphragm, flexible impeller pumps, centrifugal pumps and sliding vane - Specialty Flow Control serves more than 20 niche industrial markets.

THE IDEAL PUMP FOR YOUR INDUSTRY	This table will help you to identify the products which are most commonly used in your sector.	Industrial Flexible Impeller Pumps	Bronze Flexible Impeller Pumps	Hygienic Flexible Impeller Pumps	Motor Driven Diaphragm Pumps	Air Operated Diaphragm Pumps	Pureflo 21	Centrifugal Pump	Submersible Centrifugal Pumps	Magnetic Drive Centrifugal Pumps	Solenoid Pumps	Sliding Vane/Rotary Vane Pumps
	Chemical Suppliers & Users	•	•		•	•		•			•	•
	General Industry, Factory Plant	•	•		•	•		•	•	•	•	
	Water Treatment & Utilities	•	•		•	•						
	Food Processing			•		•						
	Cosmetics & Pharmaceuticals			•			•	•				
	Construction Equipment	•	•		•			•				•
	Dairy Industry	•		•	•	•		•				
	Agricultural Equipment	•	•		•	•		•	•	•	•	•



Flexible impeller



Sliding vane



Motor driven diaphragm



Air operated diaphragm

Heat Transfer Equipment

Pre-engineered for general applications, plate or brazed, custom for process applications and air-cool for general heating and cooling applications

Standard Xchange heat exchangers are the standard in heat transfer solutions. For naval applications, power generation, oil & gas, biofuel, general industrial, industrial OEM, mining, and chemical markets, our heat exchangers reliably perform their mission-critical duties day-in and day-out just as they've been designed, engineered and built in the USA to do. For over 100 years and counting.

Whether you need gasketed plate, brazed plate, pre-engineered or custom TEMA shell & tube or air-cooled heat exchangers, Xylem can help you evaluate, select, and install the right solution.

Advantages

- Floating end allows for differential thermal expansion between the shell and tubes
- Shell side can be steam or mechanically cleaned
- Bundle can be easily repaired or replaced
- Less costly than full interval floating head-type construction
- Maximum surface per given shell and tube size for removable bundle designs
- Capable of withstanding thermal shock
- Ease of disassembly for cleaning or replacement parts
- Very compact and rugged
- And many others

Applications

- District Heating and Cooling
- Thermal Storage
- Heat Pumps
- Radiant Floors
- Domestic Hot Water
- Pool Heating
- HVAC
- Solar Heating
- Domestic/Commercial Boilers

Models of efficiency

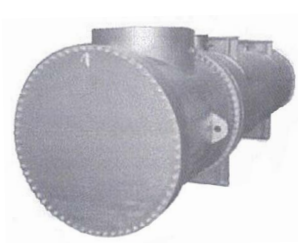

CENTURY SERIES®
Engineered/customized heat exchangers for process and other heating/cooling applications.



BRAZEPAK®
Brazed plate heat exchanger.



PLATEFLOW®
Gasketed plate & frame heat exchanger.



AIREX® AND FANEX®
Air/oil, air/air, or air/water heat exchangers.



PRE-ENGINEERED SERIES
BCF®/SSCF®/SX2000®/B300®
Pre-engineered shell and tube heat exchanger.

Submersible Stainless Steel Wastewater Pumps



D8000

Product Features and Applications

- Robust and reliable
- Excellent corrosion resistance
- Free flow-through passage
- Reduced wear
- Low maintenance requirements

The Flygt D 8050 easily pumps corrosive media for municipal sewage and industrial wastewater applications in the following industries:

- Chemical industry
- Food processing industry
- Pharmaceutical industry
- Textile industry
- Tunneling industry



Model	D 8050	D 8053	D 8056	D 8058
Power 50Hz	1.5-2.6 kW	3.5-4 kW	5-7.5 kW	9-13 kW
Backflow (DN)	50mm (2") 65mm (2½") 100mm (4")	50mm (2") 65mm (2½") 100mm (4")	- 65mm (2½") 100mm (4")	- 65mm (2½") 100mm (4")
Versions available	LT, MT, HT	LT, MT, HT	LT, MT, HT	LT, HT

Types of installation

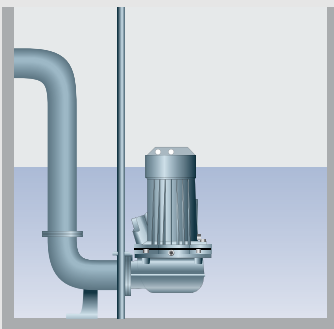

DP
Semi-permanent installation with mounting base and double guide bar.

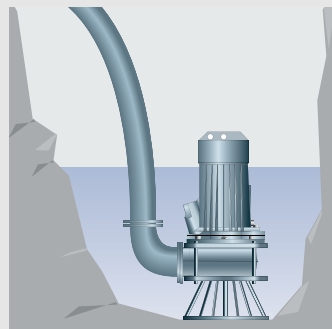

DS
Portable, for temporary installations with base and connection for flexible piping.

Flygt Concertor®



The world's first submersible pump with integrated intelligence

Flygt Concertor is the most efficient and robust solution for wastewater management no matter the type of industry you are in. This pumping system combines a fully integrated control system with IE4 motor efficiency, Adaptive N-hydraulics and intelligent functionalities. The unique benefits you will receive from these features will save you both time and money, now and in the long run.

Advantages

- Trouble-free pumping: Concertor includes an integrated pump cleaning function, built-in sump and pipe cleaning and self-cleaning Adaptive N-technology.
- Energy savings: Energy minimizer function and IE4 motor enable substantial savings.
- Simple set-up: Concertor is pre-engineered as a total solution and factory tested before delivery. Ready to plug and play without spending any additional time.
- Flexible performance: Concertor scales to your needs, pump performance can be adjusted on site or remotely, thanks to the adaptable performance field, with the push of a button.
- Impeller material options: Hard-Iron and Duplex Stainless steel



Applications

- Wastewater and contaminated water
- Cooling water
- Recirculation of sludge
- Industrial effluent
- Rainwater collection
- Transfer of process water

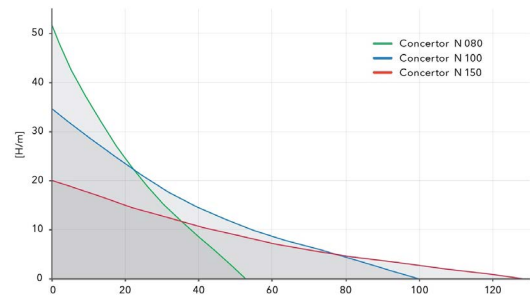

	Rating, kW	Flow	Head
Concertor N	2,2 - 7,3	80 l/s	35 m

Possible installations

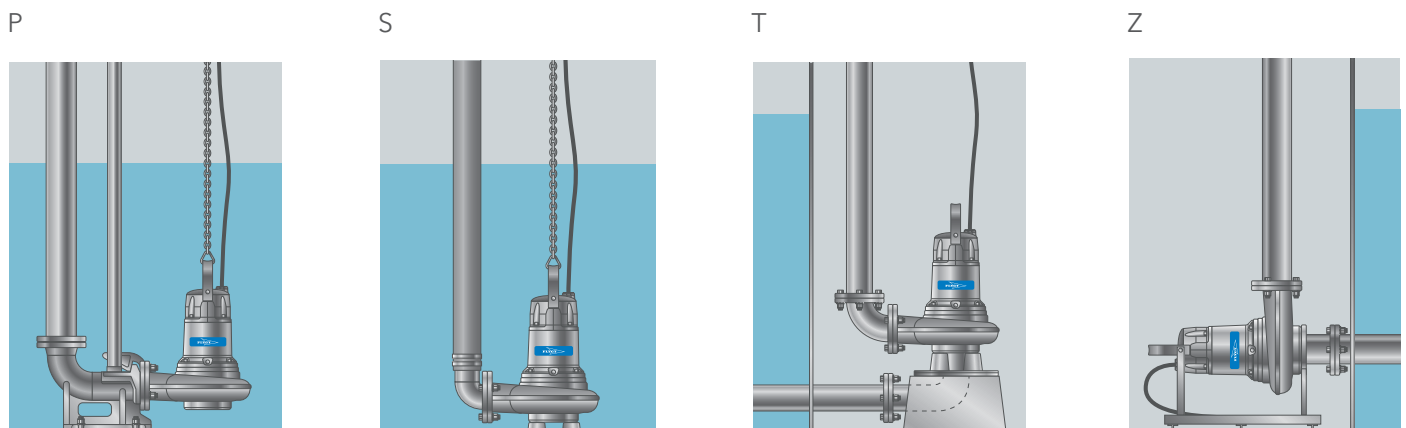

Drainage Pumps

BIBO, Ready, 2600, 2800, H5000



Advantages

- High reliability
- Resistance to heavy use
- Safe operation
- Easy to maintain
- Different compositions (cast iron, chrome casting, etc.)
- Modular pumps with several different motor and hydraulic variations

Applications

- Drainage of catch basins
- Drainage of wastewater tanks (paper pulp production, etc.)
- Pumping of runoff water, water in set-ling tanks
- Pumping of liquids with abrasive particles
- Evacuation of sludge (mines and quarries)
- Industrial residual water

H5000: for sludges with particles up to 40 millimeters in grain size.



Ready



2400



2250



H5000



BIBO 2800



2600

Model	Product type	Max. power kW	Fluid density pumped	Weight max kg	Diameter max. mm	Height max. mm
-------	--------------	---------------	----------------------	---------------	------------------	----------------

Voltage 400 V / 3 ~ / 50 Hz, 2-pole, 400 V / 3 ~ / 50 Hz, 4-pole or 230 V / 1 ~ / 50 Hz, 2-pole

2000 classic	207x, 2125, 2190, 2201, 2400, 2201, 2250	90	1.1	985	770	705 - 1,245
Ready	2004, 2008, 2008S	0.9	1.1	15	260	400 - 505
2600	2610, 2620, 2630, 2640, 2660, 2670	18.0	1.1/1.2	132	395	955
BIBO 2800	2830, 2840, 2860, 2870	18.0	1.1	154	500	991
5000	5520, 5530, 5100, 5150, 5570	170	1.5	2000	1225	2312

Smart Drainage Pumps

Flygt Bibo^α

The next generation of smart dewatering pumps

With built-in intelligence Bibo^α will cover a range of traditional drainage pumps since it adapts speed and performance in a field instead of a static curve.

Advantages

- Extremely robust, compact and easy to use
- Plug and play with no configurations needed
- Robust design ensures uninterrupted pumping in any dewatering operation
- Reduced wear up to 70%**
- Reliable performance through built-in motor protections
- Increases time between service and decreases maintenance cost by up to 50%*
- Reduces energy consumption by up to 60%* since always operating at best efficiency point

Applications

- Mining
- Constructions

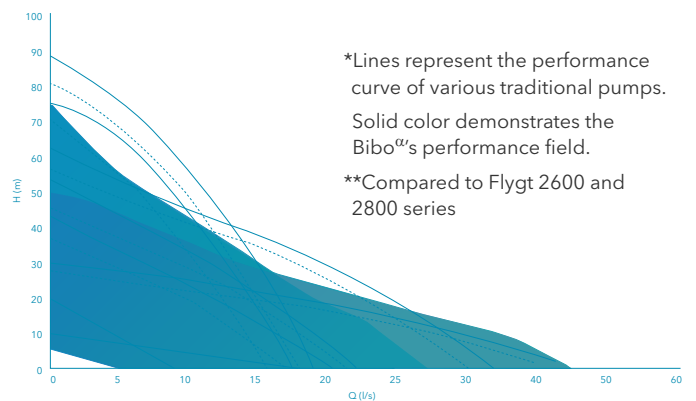
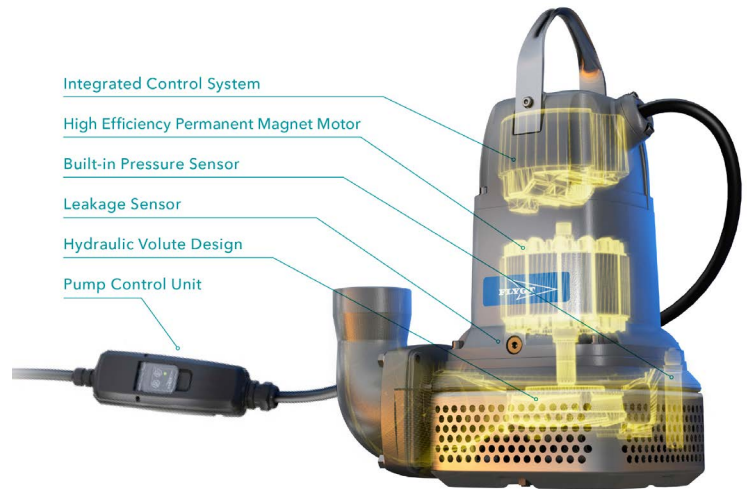

Flygt Pareo

Monitoring & control system for pumps in mines and construction

Flygt's Pareo is an external unit that, when connected to a submersible dewatering pump, delivers a smarter drainage pump solution for the mining and construction industries.

This highly portable and user-friendly unit is specially designed for dewatering in harsh environments. Using snoring detection, automatic rotation control and motor protection, Pareo reduces high maintenance costs, emergency repairs and production downtime. It can be connected to a wide range of Flygt's submersible dewatering pumps and allows our customers to insert automatization and connectivity in their mining and construction operations.



Godwin Dri-Prime®

Self-priming portable surface mounted centrifugal pumps

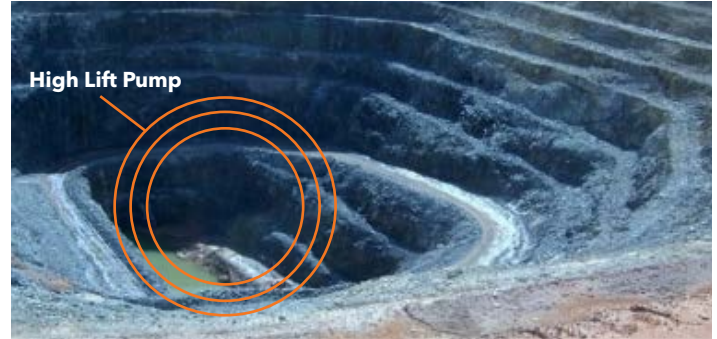

Godwin Dri-Prime pumps are a versatile range of pumps designed for use in the industry's most challenging construction, municipal, industrial and emergency response dewatering applications.

Ideally suited for tough dewatering jobs, these rugged pumps are the reliable choice for rental solutions.

The Godwin S Series of Smart pumps are equipped with Field Smart Technology (FST) for remote monitoring and control. In addition to improved hydraulic efficiency, greater fuel economy, and streamlined serviceability, the CD impeller is interchangeable with a Flygt N-Technology non-clog impeller, providing the flexibility to tackle stringy, modern waste water.

High discharge pressure, dry-running, and portability make the High-Lift (HL) series the perfect choice for mining, industrial and emergency fire backup applications.

Dri-Prime Technology

Godwin's Dri-Prime technology, provides reliable operation by automatic priming from dry up to 8.5m suction head with no operator or foot valve. There are no moving mechanical parts in the priming device resulting in lower maintenance and reduced labour costs.

Diesel and Electric

Equipped with a diesel engine for portable and standalone operation, these pumps will work on any site, no matter how remote. All engines used in UK and EU meet the Stage 5 emissions regulations.

All Godwin Dri-Prime pumps are available with electric motors, for temporary and permanent installation.

Markets and Applications



- Surface mines and quarries
- Wastewater bypass diversion
- Flood mitigation and disaster response
- Temporary pumping in the event of fire or flood
- Pumping of sludge and emptying of tanks
- Temporary raw water supply
- Turnkey dewatering solutions
- DBS Dri-Prime Back-up System
- Portable draining systems

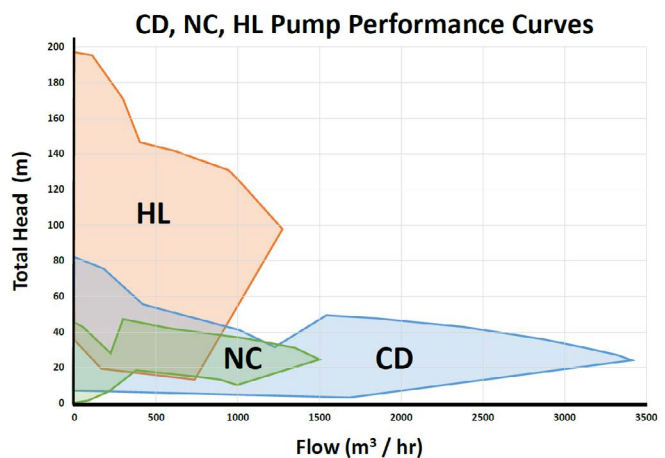

Godwin Dri-Prime® CD, NC, HL and FP series

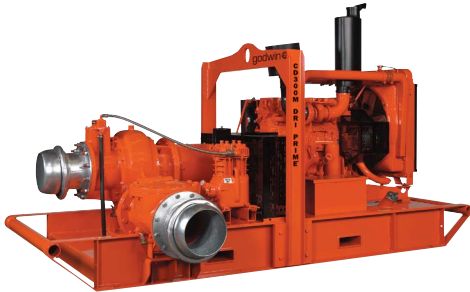

CD series for dewatering in tough conditions; and HL for high head applications



Innovative inter-changeable CD and NC impeller expands application range of Godwin S Series pumps



FP Series Flood Protection pumps are first of their class to receive FM approval



Innovations with Dri-Prime® S series

- **Versatile Solids Handling**
Interchangeable, Application-Specific Impellers
- **Innovative Pump Design**
Streamlined, Simplified Serviceability
Improved Hydraulic Performance
- **Best-in-Class Engine Solutions**
Efficient, Environmentally Friendly
- **Xylem Field Smart Technology (FST)**

Xylem Field Smart Technology - Increase service offerings, asset utilisation and customer value

Xylem Field Smart Technology (FST) is an advanced telemetry and cloud based service that allows you to remotely monitor and control your pump from anywhere in the world.



"2 pumps for 1" - CD to NC (Non-Clog)

- 15% greater fuel economy
- 20% greater pump uptime
- 40% reduced service time
- 90% less emissions
- Asset and Service Management;
- RemoteControl and Operation



- Maintain uptime of your pump and fleet, and increase asset utilisation
- Optimise maintenance schedules and reduce operational costs
- Alert to sub-optimal operating conditions
- Manage risk and improve safety
- 24/7 FST support helpdesk

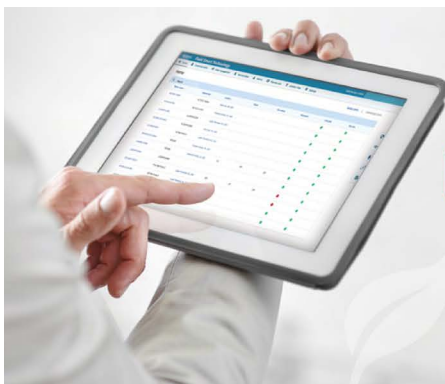

REMOTE ENGINE MONITORING AND CONTROL

Speed | Temperature | Battery Voltage | Oil Pressure | % Load
% DPF Soot | Fuel Rate | Fuel/DEF Levels* | Engine Hours
Start | Stop | Accelerate | Decelerate
Engine Diagnostic Codes

REMOTE PUMP MONITORING

Suction/Discharge Pressure* | Vibration RMS*

REMOTE SYSTEM MONITORING

Flowrate* | Turbidity* | pH Level* | Fluid Temperature*
Pressure* | Total Suspended Solids* | Sump Level*

ALARMS AND NOTIFICATIONS

Text | Email | Automated Telephone Alarming

MULTI-LANGUAGE

English | French | German | Italian | Spanish

*Additional equipment required

Custom Pumps



At Xylem, Custom is what we do. We manufacture some of the world's largest pumps. This greatly extends the range of products we can offer. A few of the advantages we have are best in class efficiency and some of the world's largest testing facilities.

Custom column pumps



WCAX, YDD, WCA, WCF & WCB

Semi-open impellers

Capacity : 10.000-100.000+ m3h
Heads: 2-34 m TDH, single stage
Sizes: 1000-2.600 mm or larger discharge
10 Model impellers

Custom split case pumps

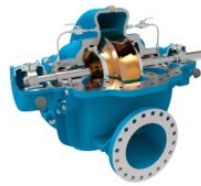

WS

Double suction split case pumps

Capacity : 1.500 - 39.000 m3h
Heads: 9 - 150 m
Sizes: 400-2.000 mm

Custom axial Flow pumps



WCXH

Capacity : 113.000 m3h
Heads: 1-5 m
Sizes: up to 3,35 m

Custom dry pit pumps



WSY/SSE/SSF

End suction dry pit pumps

Capacity : 40.000 m3h
Heads: 90 m
Sizes: 500-1600 mm

Testing Capabilities

At Flygt, we're focused on performance. That's why we do more than manufacture world-class pumps at our custom pumps plants located in Pewaukee, Wisconsin, USA and India. We test them there, too. By investing in exclusive in-house testing capabilities, we can test some of the world's largest pumps. As a result, we can verify the performance and energy efficiency of these pumps for a guarantee.



Pewaukee testing facility



India testing facility

Packaged Pump Stations and Engineered Pumping Solutions



Ready-to-install “pump and play”

Xylem offers pre-engineered, pre-fabricated pumpstations combining premium pumps with dedicated monitoring and control options configured to meet your needs of future integration. The pumpstations are designed for maintenance free operation and high reliability, also under difficult conditions. An extensive range of pumps for any media and remote connectivity will secure high performance and reliability combined with low operational cost.

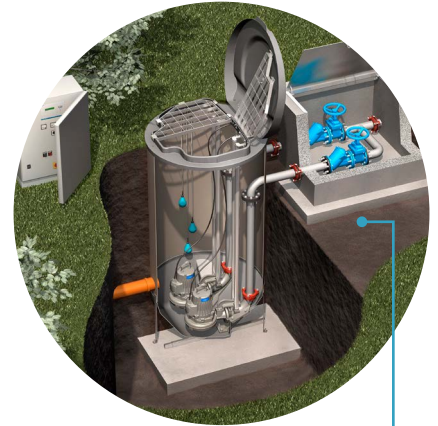

Prefabricated Flygt TOP station with clog free submersible pumps

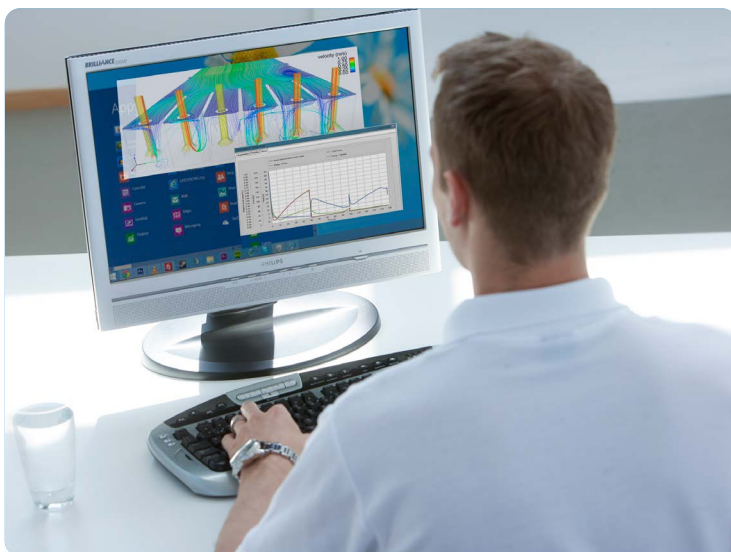

CFD experts and tools for optimal design

Hydraulic modelling to simulate the operation of your station

When designing a pump station, our goal is to help our customers to achieve the lowest total cost of ownership. We always try to design a pump station as small as possible to minimise the capital cost. We analyse the operating conditions and advise on the best operating strategies to minimise energy costs. We also address potential problems with sediment or floating debris to eliminate, or at least reduce, cleaning and maintenance costs. CFD analysis is often a critical factor in achieving these objectives.

UV Disinfection Systems

Reliable, chemical-free, and environmentally friendly water and wastewater treatment solutions that combines intelligent control with the advanced energy-efficient UV lamp and ballast technology. Our UV system gives you just the right dose with minimal energy consumption. And with our third-party performance validated systems, you can be assured to meet regulatory compliance requirements in a variety of applications.

Advantages of UV solutions

- Deactivation of pathogens, viruses, bacteria and parasites
- Lower energy consumption
- Micro-pollutant removal
- Odor and taste removal
- Eco-friendly solution as no harmful chemical residue (such as chlorine) remains, and it has no unpleasant odor
- Easy to install, with low maintenance
- Perfect for water reuse applications
- Legionella prevention

Applications

- Drinking water
- Water reuse or water recycling
- Cooling water
- Wastewater treatment
- Advanced Oxidation Processes (AOP)
- Aquaculture
- Food and beverage
- Pharma and life-science



Aquada



Wedeco Acton PE 660



Wedeco Spektron 250 and Spektron i



Wedeco Duron open-water UV disinfection system

Model	Power	Description & Applications	Flow
Aquada	35 -85 Watts	The Wedeco Aquada UV disinfection system is a drinking water treatment solution that can be easily integrated to the existing water pipelines of individual homes, apartments or mid-rise.	0.73 m ³ /h - 10.10 m ³ /h
Spektron	0.1 - 36.6kW	Certified UV disinfection system for drinking water applications in industrial and large municipal applications.	6.6 m ³ /h - 6.032 m ³ /h
Spektron i	0.1 - 0.78 kW	UV disinfection system tailor-fitted for a wide array of industrial water applications such as food and beverage, general industry and manufacturing.	6.6 m ³ /h - 152 m ³ /h
ME	0.52 -1.61 kW	Especially designed for highly-processed water used for cosmetic, pharmaceutical, semiconductor and food and beverage production applications.	Up to 100 m ³ /h
LBX	0.34 - 20.57kW	This system is validated and certified to perform in conditions with low UV transmissions and pressurized environments for wastewater, surface water, processed water and reuse water applications.	10.2 m ³ /h - 1,346 m ³ /h
Duron	tailor-made	An open-channel UV disinfection system that has been third party validated for wastewater and aquaculture treatment.	≥ 750 m ³ /h
Quadron	1.5 - 48kW	Made to fit in tight spaces for clean water applications such as fish farming, industrial processed water and municipal water.	1,200 m ³ /h - 4,100 m ³ /h
Acton PE	0.46 - 3.9 kW	Designed to withstand the corrosive conditions in applications like aquaculture farms, aquaria, salt-water thermal pools and well boats. Made of polyethylene HDPE (PE100) to endure saltwater, guaranteeing resiliency and performance also in demanding conditions.	80m ³ /h- 829 m ³ /h

Ozone Oxidation Systems

Advantages Ozone solutions

- Eliminates bacteria, viruses and most other organic and inorganic
- In specific applications ozone can significantly reduce the levels of dangerous chemicals, such as Chlorine.
- Acts as a micro flocculant aiding in the removal of minerals such as iron and manganese.
- Generated on site and on demand from air/oxygen and power.
- No storage and handling of chemicals.
- Easy to install and low maintenance



Wedeco SMOevoPLUS Ozone generator



Wedeco PDOevoPLUS Ozone generator

Applications

- Drinking water
- Micro pollutant removal
- Odor and Taste nuisance removal
- Process water cycles
- Water reuse or water recycling
- Cooling water
- Industrial laundries
- Pulp & Paper
- Wastewater treatment
- Lowering of the soluble COD
- Advanced Oxidation Processes (AOP)

Wedeco Ozone oxidation systems

Easily fit and install ozone processes in your operation with the plug-and-play systems, and deliver maximum performance that meet specific needs with our large range of engineered and customizable systems.

Xylem's Wedeco small to large ozone systems feature advanced Effizon® evo 2G electrode technology. Its superior generator designs that fit small footprint, provides an unparalleled performance, efficiency and operational stability.

Model	Description	Production of ozone
GSO-18 & OCS	Designed to meet the customer's need have a easy-to-install and easy to operate ozone unit that complies with DIN 19627, CE-EMVG and DGUV rule 103-001.	2g/h up to 400g/h per unit
SMOevoPLUS	Made for small to medium ozone productions. This system control unit can be combined and supplemented with numerous option sets that allow project-specific customization for almost all applications.	200g/h up to 20,000g/h per system
PDOevoPLUS	Large ozone systems, that are fully customized and integrated, fitting seamlessly into local conditions and processes/applications.	15.3kg/h up to more than 200kg/h ozone per system

Mixers

Adaptive, 4460 Biogas, Single Speed Mixers



With over 250,000 mixer installations in the wastewater industry and various industry applications, Flygt has proven performance and energy efficiency that can drive your wastewater treatment operation to an optimum level. It's single-speed mixers and Biogas mixers boast of robustness, long product life-cycle and energy efficiency demonstrating savings in several aspects to its customers.

Advantages:

- Over 50 years of experience in mixing technology
- Up to 50% energy savings
- Robust design that endures harsh water conditions
- Controllable and adjustable output via a tank-side control panel, PLC, or a plant-wide control system
- Adaptive Mixer series have integrated monitoring functions and are scalable for easy upgrade to an automated operation and improved process resiliency

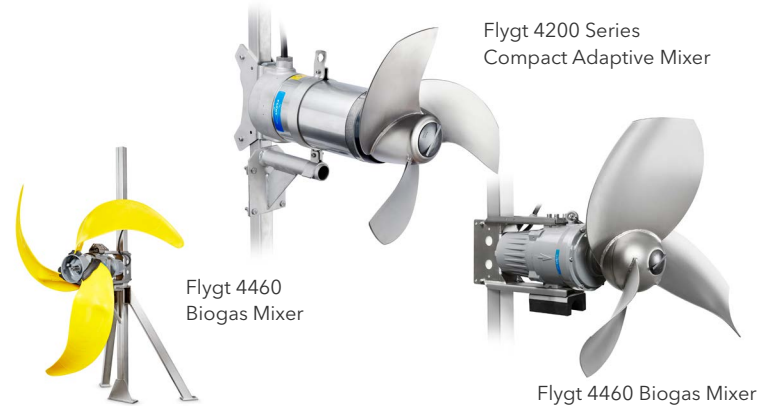

Applications

- Quenching tanks
- Drilling mud
- Biogas
- Treatment of activated sludge
- Aeration tanks
- Retention basins
- Prevention of ice formation
- Settling tanks
- Mixing of liquids with abrasive particles
- Oxygenation in lakes and ports
- Resuspension, homogenization

Model	Description	Advantages & Applications	Power	Propeller diameter (m)	Thrust (N)
4320	Geared Adaptive mixer	Intelligent and industry leading high efficient low-speed geared mixer with integrated drive and IE4-motor. Designed for manual or automated adjustment of output according to variations of operating conditions in large tanks.	1.1-5.5kW	1.4 - 2.5	up to 5,180
4200 Series	Compact Adaptive mixer	Intelligent and industry leading high efficient compact mixer with integrated drive and IE4 motor. Designed for manual or automated adjustment of output according to variations of operating conditions in small and medium size tanks.	1.1 - 7.3kW	0.37 - 0.77	up to 2,470
4460	Geared Single Speed Biogas mixer	Designed for demanding biogas applications with high viscosity liquids and high yield stress. Provides effective mixing with low energy cost, and maintain substrate homogeneity.	5,7 - 12kW	1.0 -2,5	up to 3,650
4400 Series	Geared Single Speed mixer	High efficient classic low-speed geared mixers for tanks with large fluid volumes with strong bulk flows, when horizontal flow is essential and space is available.	2,3 - 4,4kW	1.4 - 2.5	up to 3,910
4530	Geared Mid-size Single Speed mixer	Energy efficient mid-size mixer for activated sludge processes, oxidation ditches, sludge holding tanks, anoxic/anaerobic zones, MBBRs, and SBRs.	2,3 - 4.3 kW	1.2	Up to 2,450
4600 Series	Compact Single Speed	Most versatile heavy duty mixers with special options such as hard iron propellers and cooling jet rings. Great for tight spaces and harsh environments with high solids content and high temperatures.	0.9 - 23kW	0.2 - 0.77	Up to 4,800

Wastewater Aeration

TurboBLOWERS and Fine Bubble Aeration Systems



TurboMAX and TurboLIGHT blowers

Primarily used in activated sludge plants, in both municipal and industrial wastewater treatment, the Sanitaire TurboBLOWERS portfolio covers multiple different blower sizes producing the oxygen required to fit your application.

Each blower size has several models allowing more flexibility in designing a system that accurately meets your needs without over- or under-sizing the blowers.

	TurboLIGHT	TurboMAX
Block power	7.5-37kW	7.5-600kW
Flow rates per blower	300-2,700 m ³ /hr	300-41,000 m ³ /hr
Treatment plant size	2,000-70,000 PE	2,000-1.5M+PE

Core Components Reduce Power Losses

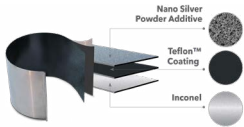

Airfoil Bearing - Nano Silver Triple Treatment Bearing (NSTB)

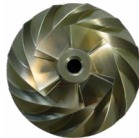

Core Drive Unit/ Impeller

The TurboMAX and TurboLIGHT series are ideal for a broad range of wastewater treatment plants with performance as shown in the table.

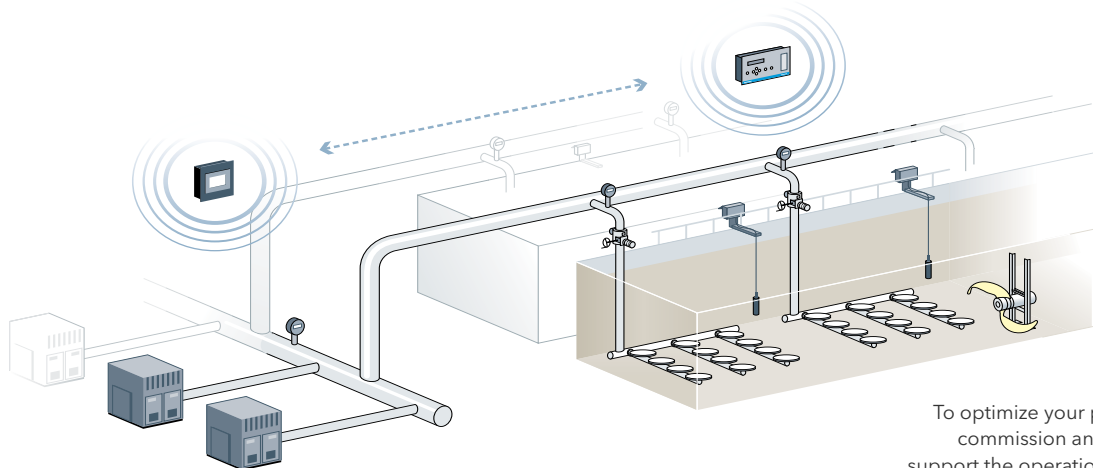

To optimize your process, we design, deliver, commission and, through control systems, support the operation and maintenance of your aeration system - from blowers to diffusers.

Aeration Systems

For reliable oxygen transfer in all types of wastewater aeration applications, choose Sanitaire diffused aeration systems. No matter the tank geometry or process application, Sanitaire systems have proven effective in thousands of communities and industries worldwide.

- For a combination of high aeration efficiency and low operating costs, there's the Silver Series II membrane diffuser - the most widely used fine bubble diffused aeration system available today, or the Silver Series II LP is 9" featuring a modified slit pattern to handle airflow.
- Ceramic diffusers handle aeration of aggressive, highly corrosive wastewater, delivering high oxygen transfer that's both efficient and cost effective.



Analysis Throughout the Industrial Supply Chain



Xylem’s analytical involvement spans right across the manufacturing and distribution cycle; monitoring the **water** we use to irrigate crops, within the **production** and **cold-chain distribution processes**, right through to the **consumer**.

Our expertise within the municipal wastewater sector offers far more value than monitoring systems alone and now extends deep into industrial environments; ensuring compliance with local water outlet regulations as well as providing for quality control, safety and efficient processing throughout the supply chain.

Innovative solutions every step of the way

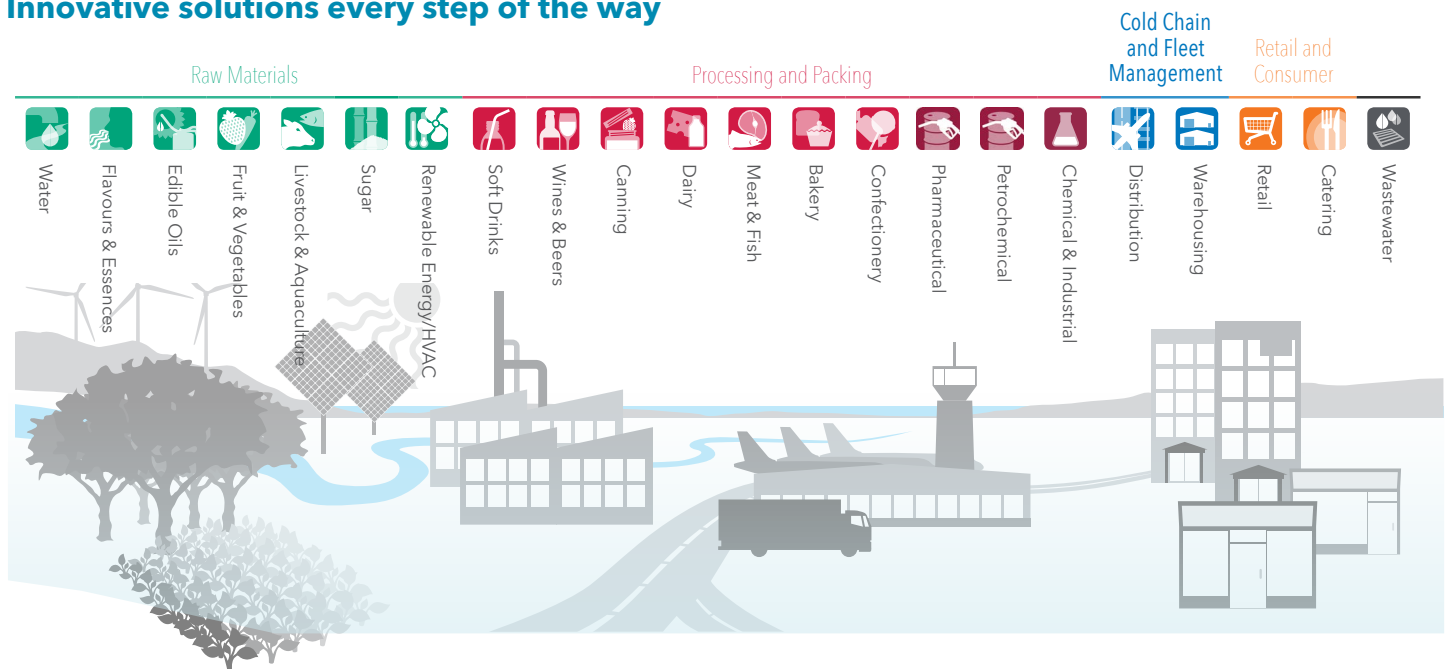

Practical Analysis

- Refractometers • Polarimeters • Spectrophotometers • Photometers • Dissolved Oxygen • Turbidity Density • Viscometers

Chemical Analysis

- Titrators • pH Electrodes • Conductivity Electrodes Biochemical Analyser • pH/ORP • GC Detectors • Purge & Trap • TOC Analyser • VOC Analyser

Physical Measurement

- Temperature & Humidity Dataloggers • Oil Quality Meter • Pressure Datalogger • Precision Thermometers

Pipeline Condition Assessment Services

Technologies and expertise to detect leaks, gas pockets and structural weaknesses in pipes and prevent network failure, Xylem can help you to find the exact location of problem areas, to detect and fix weaknesses before they cause a major shutdown.

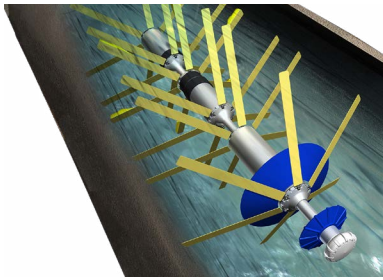

PipeDiver®

Pipeline condition assessment

Xylem’s pipeline condition assessment services can shed more light on the health of your most critical pipe infrastructure.

Xylem’s solutions can address the needs of both metallic and concrete pipes in water main networks and sewer rising mains.

The assessment approach includes a preliminary analysis for the selection of the specific technology, the pipe assessment for the detection of defects and gas pockets that are sources of failure, and finally a risk assessment for the evaluation of main failure and its consequences.

Inline leak detection

Xylem’s inline leak detection solutions can accurately locate leaks in your water transmission mains by bringing the sensor at the source of the leak.

Identifying leaks and their severity can help prioritize the most critical sections in need of urgent attention as operators cannot afford to shut down the service completely and excavate large portions of a city street to search for suspected leaks.

The accuracy of inline leak detection can effectively reduce shutdown and excavation times, allowing operators to carry out fiscally responsible and efficient repair projects.

24x7 pipe condition monitoring

Xylem’s acoustic fiber optic technology allows for continuous monitoring of prestressed concrete cylinder pipes (PCCP) to identify critical issues in real-time, thereby enabling network operators to take prompt corrective action to prevent failures.

The monitoring system is able to identify wire wrap breaks, alerting asset managers when there is an unacceptable increase in activity that could lead to pipe failure.

Xylem’s transient pressure monitoring analyses the operating pressure in a pipeline to understand the system hydraulics and the effect of pressure surges.

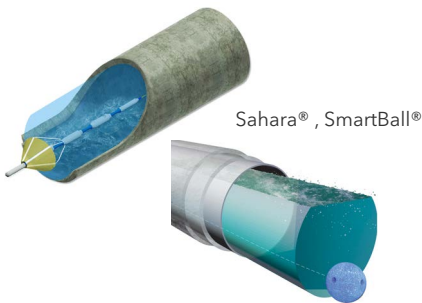

Sahara®, SmartBall®

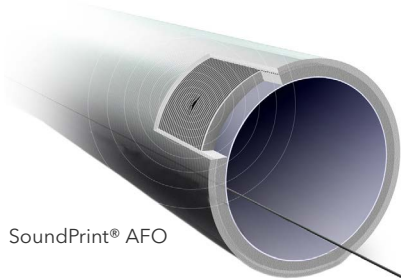

SoundPrint® AFO

	SmartBall® Leak Detection	Sahara® Leak Detection	PipeDiver® Ultra
Tool Type	Free-Swimming	Tethered	Free-Swimming
Pipe Materials	All	All	Steel, Ductile Iron and Cast Iron
Pipe Diameter	250 mm and larger	250 mm and larger	450 mm to 1320 mm
Typical Location Accuracy	± 2 m	± 0,5 m	50 mm by 20% wall loss
Insertion point size	100 mm or larger	50 mm or larger	≥ 300/400 depending on the insertion
Inspection Length	Up to 24 hours	0,8-1,5 km per insertion	Up to 14 hours
Pipeline Mapping	Yes	Yes	Yes
Inline video	No	Yes	Yes

Industrial Water Meters

Cordonel®, MeiStreamRF and MeiTwinRF



High-performance, reliable and accurate measurement of clean water

Advantages

- Accurate measurement of high and low flow rates
- Durable construction with long operational life
- Secure data analysis and communication capabilities
- Measurement and leakage detection for challenging environments
- Easy fitting with U0D0 - does not require straight sections
- Handling non-ionised, low-conductivity water
- Pulse output modules for real time control
- Measurement of potable water up to 50 °C
- Multiple pipe diameters to support a wide range of applications
- Fully compliant to MID and OIML potable water standards

Applications

- Water consumption/measurement
- Network monitoring
- Boundary metering
- Leakage detection
- Monitoring of process water intake
- Water dosing
- Process control
- Water supply/distribution
- Irrigation
- Fire protection

Make it smart! Available with various communication solutions for remote reading (SensusRF, DIAVASO, Wireless M-Bus, Pulse output etc)

Cordonel® Static Flow Water Meter for a Smarter Network



MeiStreamRF Water Meter with an Electronic Register

MeiTwinRF Compound Water Meter with an Integrated Radio



Model	Meter size	Minimum flow m ³	Max. peak flow m ³
Cordonel	DN40 to 100	0,04 to 0,16	78 to 310
MeiStreamRF	DN40 to 300	0,25 to 15,9	60 to 2000
MeiTwinRF	DN50 to 100	0,006	90 to 280

Industrial Thermal Energy Meters



PolluStat®, PolluTherm®, PolluFlow® and PolluWatt™ Duo II

High-precision measurement of energy consumption in heating and cooling circuits

Advantages

- Accurate and reliable measurement
- Wide range of applications supported
- Ultrasonic principle without moving parts
- Upgrading capabilities for remote readout and data communication
- Modular communication interfaces for flexibility and lower storage costs
- Can also be used in combined heating and cooling systems
- Automatic switch-over point for energy storing in separate registers
- Comprehensive logging capability
- Exchangeable battery
- Separate 230V or 24V mains power supply module available

Internationally approved! Meets regional, international and national standards, including: MID, EN1434, OIML R75



PolluStat® Compact Ultrasonic Thermal Energy Meter



PolluTherm® Energy Consumption Measurement Integrator

Applications

- District Heating
- Industry Heating
- Commercial Heating
- Cooling (HVAC) Domestic Warm Water Generation
- Charging Systems
- Consumption billing and monitoring for industrial plants/large buildings
- Heat sub-stations for primary networks
- Network billing and heat exchange stations
- C&I billing and heat production monitor



PolluFlow® Ultrasonic Thermal Energy Flow Sensor



PolluWatt™ Duo II Calculator Dedicated for Industrial Application

Model	Meter size	Nominal flow m ³
PolluStat	DN15 to DN40	0,6 to 10
PolluTherm + PolluFlow	DN15 to DN100	0,6 to 60
PolluWatt Duo II + PolluFlow	DN15 to DN100	0,6 to 60

To address the challenges in efficiency managing water infrastructure assets, Xylem has leveraged its expertise in co-creating digitally-enabled services with the people who operate these assets. Xylem has designed a suite of digital service packages tailored to deliver outcomes that save costs and improve efficiency.

Smart Condition Monitoring

- Online condition monitoring
- Predictive maintenance
- Detects upcoming failures with electrical waveform analysis and AI
- Prioritized service
- Prevent unplanned downtime

Xylem Digital Maintenance (XDM)

- Geo-tagged assets
- Customized dashboards
- Alarm handling
- Service scheduling
- Contract management
- API support
- Scalable and Modular

Avensor Cloud

- Connected pump stations
- Alarm services
- Data driven insights
- Plug & Play solution
- Non-Xylem product support
- Retrofit capability

Aquaview (SCADA)

- Monitor and control assets
- Improved uptime
- Scalable based on need
- Performance optimization

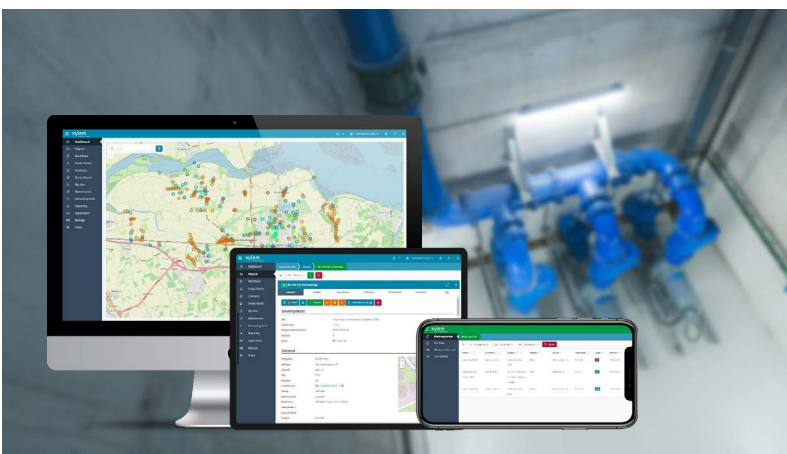

The best products are only half the reason to work with us.



Our people make the difference

Industrial-strength thinking helps us engineer, design and manufacture the highest quality pumps and related equipment. But that's not all. We apply the same dedication and expertise to every aspect of our relationship with you. Our people - and how they partner with you - are what makes Xylem the right choice for your industrial water and fluid management solutions.

Our expertise solves the challenge

Nobody spends more time thinking about industrial water and fluid management. With hundreds of thousands of customers and millions of installations, we have more experience across more types of challenges, and can design solutions that provide more value today and tomorrow.



Aftermarket & Service

To provide fast and reliable maintenance and repairs of our Xylem products in all kinds of industries everywhere in the world, we have established a network of authorized, local service providers. We are pleased to recommend our professional and experienced Xylem Authorized Service Partners.

When you go to a Xylem Authorized Service Partner you can be sure to receive qualified, high-quality service. Our partners are trained and certified to provide Xylem specified services, including the following:

- Installation & Commissioning
- Repair & Maintenance
- Maintenance Agreements
- Inspection & Auditing
- Plant and equipment upgrades/refurbishments
- Genuine Spare Parts

Xylem Rental Solutions

Backed by the world's most trusted water and wastewater expertise, Xylem Service & Rental provides the full range of technical and field support needed to minimize risk, maximize uptime and control lifetime costs. From designing smarter next-generation systems to 24/7 turnkey operation, it's our job to help you solve even the most complex water and fluid challenges.

- Bypassing of wastewater
- Drainage of tanks
- Hiring of equivalent equipment during maintenance or while repairs are being effected
- Temporary pumping for fire prevention
- Temporary raw water supply
- Trial hiring before purchase
- Cleaning out of tanks, water tests, etc.





Total peace of mind

Maybe you need help deciding whether to refurbish or replace existing equipment. Maybe you need to find a way to lower operating costs or troubleshoot an issue. Maybe you want to outsource maintenance and upkeep. Or maybe you need a flexible way to pay for new equipment. Whatever you need to support your industrial water and fluid management process, we do it. Our portfolio of services will give you total confidence in your system 24/7.

Industrial-strength parts & support

Xylem designs equipment for reliability, longevity and low total cost of ownership. That said, there will come a time when routine maintenance is necessary to maintain peak performance. Genuine Xylem parts ensure optimal, reliable performance of your Xylem equipment and can be delivered directly to you or with technical support. If you prefer to handle upkeep yourself, we have you covered:

- Operator training
- Equipment service training
- Technical coaching
- Genuine parts kits

Committed to solving water

The facts speak for themselves: worldwide, 844 million people lack access to clean drinking water. 443 million school days are lost to water-related illness. 361,000 children under 5 die from diarrheal diseases every year.* And 90% of natural disasters are water related. It's clear the world is facing unprecedented water challenges brought on by population growth, urbanization, shrinking fresh water supplies and increasing storm severity.

At Xylem, we take our role as leaders in water and fluid management seriously and are committed to finding solutions to the world's most pressing water challenges. Our mission is to provide and protect safe water resources for communities in need around the world, and to educate people about water issues.

To learn more about Watermark, our corporate citizenship and social investment program, visit xylemwatermark.com

*Source: UNICEF/WHO

Industrial-strength thinking solves more than water.

For over 170 years, Xylem has led the way in water and fluid management. We can analyze, customize, engineer, and install a complete solution that will help you focus on your core business, build profitability and solve complex challenges the right way. Give us a call to see what industrial-strength thinking can solve for you.

Xylem |'zīləm|

- 1) The tissue in plants that brings water upward from the roots;
- 2) a leading global water technology company.

We're a global team unified in a common purpose: creating innovative solutions to meet our world's water needs. Developing new technologies that will improve the way water is used, conserved, and re-used in the future is central to our work. We move, treat, analyze, and return water to the environment, and we help people use water efficiently, in their homes, buildings, factories and farms. In more than 150 countries, we have strong, long-standing relationships with customers who know us for our powerful combination of leading product brands and applications expertise, backed by a legacy of innovation.

For more information on how Xylem can help you, go to [Xylem.com/industrial](https://www.xylem.com/industrial)



Xylem Inc.
[xylem.com/industrial](https://www.xylem.com/industrial)

AC Fire Pump, Flygt, Godwin, Goulds Water Technology, Leopold, MJK, OI Analytical, Pure Technologies, Sanitaire, Sontek, Standard Xchange, Wedeco, and YSI are registered trademarks of Xylem Inc. or one of its subsidiaries. Goulds is a registered trademark of Goulds Pumps, Inc. and is used under license.
© 2021 Xylem, Inc.