



THE COMPLETE GUIDE TO

# Stormwater Management

**xylem**  
Let's Solve Water



# Introduction

Welcome consultants, civil and application engineers, planners and users of stormwater systems around the world.

We have created this detailed guide to outline the many ways in which we can help you resolve some of the most challenging scenarios related to stormwater management, flood prevention and relief. In our view this is achieved through smart pump station design, innovative solutions, state of the art equipment and capacity utilization with network optimization.

For more than 60 years, our engineers have resolved issues ranging from compact, cost-efficient pump sump station design, correct pumping duty conditions and monitoring and control requirement, to data collection and analysis, as well as tailor-made stormwater projects. Some examples of their work are highlighted throughout this document.

The objective of sharing all this information is to give you answers and guidance into how to maximize a community's capacity to manage stormwater. This is our way to contribute to eliminate the danger to people, property and the environment that severe stormwater events can cause.

We hope you find this resource useful and welcome your feedback. Comments and inquiries can be sent through your local Xylem sales engineer or contact information on our website: [www.xylem.com/en-us/support/contact-us/](http://www.xylem.com/en-us/support/contact-us/)



Tomas Brannemo  
President, Transport and Treatment, Xylem.

# Table of Contents

---

2 **TABLE OF CONTENTS**

04





Over the last 50 years, the global urban population has grown from 1.2 to 4.5 billion.



Half a century from now, our global urban population is projected to reach seven billion.<sup>1,2</sup> In the meantime, changes to global climate patterns are causing more intense rainfall and pronounced droughts. Although modern cities have the necessary infrastructure in place to control the resulting stormwater, often the systems they have in place are outdated and not designed for a long service life.

Many cities continue to operate conveyance structures, which contain parts that are multiple decades old; implemented before planners became aware of the issues of climate change and rapid urban expansion. Today, urban growth and increasingly intense rainfall events cause these systems to be overloaded, resulting in frequent and serious flooding.

Moving forward, stormwater control infrastructure will be required to live up to the challenges of population growth and climate change. It will also need to function properly in a world in which urban densification will make less space available for the implementation of stormwater control solutions. From an engineering perspective, stormwater assets will need to be considered in a broader context.

Copenhagen is a prime example of this. In the last decade, Denmark's capital city and home to over 1.2 million people has suffered flood damage in excess of one billion Euros.<sup>3</sup> As a result, the city brought together specialists from many different disciplines to develop a 20-year plan aimed at improving water resilience. Copenhagen's plan integrates a wide variety of solutions for flood protection and recreational stormwater usage; it also includes measures such as building blue and green streets and parks, constructing rain gardens and using roads as open waterways for extreme stormwater relief.

The infrastructure needed for urban stormwater control is significant in terms of both scale and expense, and it can't be replaced on a whim. It is built for a century of intended service life and requires long-term planning. Meanwhile, continuous upgrading and refining of this infrastructure will be critical to solving acute issues on the fly without undermining long-term planning goals. This requires an in-depth understanding of every aspect of your stormwater control system, from the technical details of complex system interactions, to knowledge of the socio-economic and public perception implications.

The only way for modern cities to meet present and future water productivity, water quality and water resilience needs is to implement the best available technologies in a resilient, long-term planning context.



**Jes Vollertsen**  
Professor, Institut for Byggeri og Anlæg  
Thomas Manns Vej 23  
Lokale: 1-258  
9220 Aalborg Ø, DK

<sup>1</sup> <https://esa.un.org/unpd/wup/Publications/Files/WUP2014-Report.pdf>

<sup>2</sup> [https://esa.un.org/unpd/wpp/Publications/Files/WPP2017\\_KeyFindings.pdf](https://esa.un.org/unpd/wpp/Publications/Files/WPP2017_KeyFindings.pdf)

<sup>3</sup> <http://www.forsikringogpension.dk>

# Defining Stormwater Management

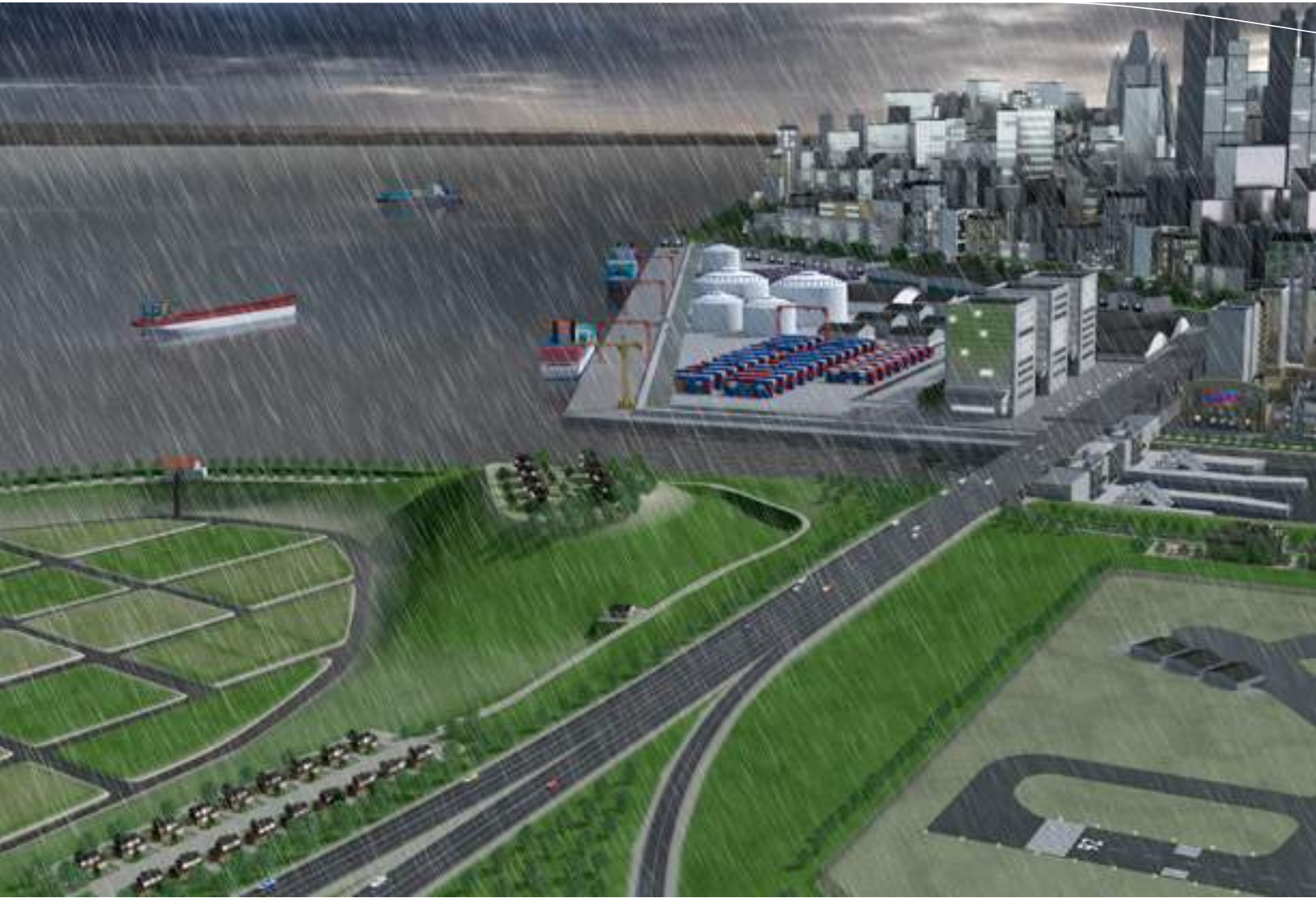





In rural environments, a majority of rainfall infiltrates into the ground, while some excess slowly forms runoff streams or watercourses. In cities and other urban spaces, rainfall collects rapidly and becomes runoff as the impervious surfaces of streets, paved areas and rooftops prevent it from infiltrating into the ground.

Rainfall events also impact bodies of water, such as rivers and lakes, causing their water levels to rise periodically. Since many urban centers are built in the vicinity of these bodies of water, measures must be taken to prevent them from flooding.

Stormwater management refers to the way in which these flows, and their potential pollutants (sand, chlorides, organic matter and even large objects), can best be managed using a wide range of solutions.

It covers a broad spectrum of activities, from planning and measurement, to monitoring and control, as well as pumping and treatment. It includes infrastructure such as gutters, conduits and trenches, in addition to detention tanks, large and small pump stations and treatment plants.

Continue reading to discover what successful stormwater management looks like in urban spaces, and how the right solution can help you effectively improve water resilience in any environment.

Water is a vital resource  
that is deeply integrated into urban life.

In spite of this, urbanization can radically change the flow of water and create a range of adverse effects, such as frequent, severe floods and changes in water quality.

Around the world, urban water managers are constantly dealing with these issues, as well as other new and unprecedented challenges posed by stormwater events. Investing in an efficient stormwater collection system, applying best management practices (BMPs) and implementing the right pumping storage and treatment infrastructures can help these individuals protect their communities from evolving natural hazards.

## Sponge Cities

To accommodate rapid urban migration and development, some countries are turning to sponge city initiatives.

The sponge city concept proposes the implementation of sustainable and ecological flood control methods with minimal footprint and energy consumption. It employs ecological principles, landscape architecture approaches and key techniques of infiltration, pumping, storage, purification, utilization and discharge. These techniques are applied through best management practices (BMPs) and green stormwater infrastructures (GSI) with low impact, as decided by each municipality.

One of the most ambitious sponge city programs is being developed in China, which launched pilot cases in 16 different cities in 2015 and plans to roll the scheme out nationally. To assist in sponge city development, the Chinese government provides annual funding to qualified cities and municipalities across provinces.<sup>4</sup>

By 2020, China hopes that 80% of its urban areas will be able to absorb and re-use at least 70% of rainwater.<sup>5</sup>



<sup>4</sup> <http://chinawaterrisk.org/about/>

<sup>5</sup> <http://www.cnn.com/2017/09/17/asia/china-sponge-cities/index.html>

## A | SELECTING THE RIGHT STORMWATER CONTROL SOLUTION

### A1

#### COMBINED SEWER SYSTEM *VERSUS* SEPARATE SEWER SYSTEM

Begin your evaluation of urban stormwater control solutions by identifying which type of sewer system your community has in place. Sewer systems can either be combined or separate, and each type comes with different risks and benefits.

Combined sewers, for example, are designed to collect both wastewater and stormwater through a single pipe system. Separate sewers consist of two isolated pipe systems—one for wastewater and another for stormwater. In a separate system, stormwater is conveyed to a designated outfall and commonly discharged directly into the receiving water. In a combined system, the flow of stormwater and wastewater is directed to a treatment plant prior to being released to natural sources.

The figures below show the potentially severe environmental consequences of a combined system overflow. In the event of heavy precipitation or snow meltdown, large quantities of mixed and untreated stormwater and wastewater may be released into nearby bodies of water.

Use a comprehensive review of your community’s current sewer system as the foundation for making decisions regarding efficient stormwater collection, detention or retention, transport to a treatment plant and release.

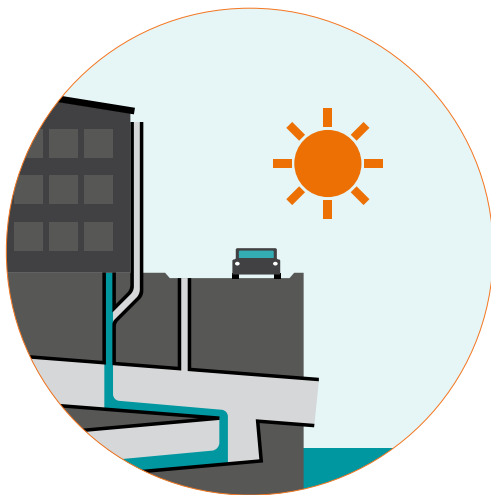

Combined Sewer System  
(CSS)



Combined Sewer Overflow  
(CSO)

## A2

### STORMWATER DISINFECTION

Rain events can cause combined sewer overflows (CSOs) when conveyance systems or treatment plants are overwhelmed by stormwater. In addition to polluted runoff, CSOs contain pollutants and pathogens from raw sewage that pose potentially serious environmental and public health risks. Separate stormwater systems may also contain pollutants and pathogens if they contain illegal connections and dumps, leakages, or if the flushing effluent is contaminated.

In the case of both combined and separate systems, disinfection inactivates pathogens, making the released water significantly safer. Ozone and UV treatment are among the most efficient methods for disinfecting water. They are more effective than traditional chlorine-based methods and do not form disinfection by-products (DBPs).

Modify and implement various wastewater disinfection methods to treat stormwater before it is released back into the environment. Xylem's **WEDECO** brand offers a range of products and extensive expertise in water disinfection. Please contact your local Xylem office for more information and a detailed consultation. For reference and case stories, see our "Case Studies and White Papers" section on our global platform.



**WEDECO**  
a xylem brand

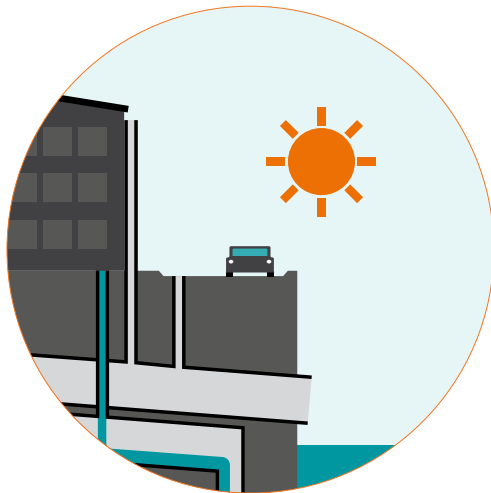

Separate Sewer System  
(SSS)



Separate Sewer Overflow  
(SSO)



## A3

### OPTIMIZATION OF URBAN WATERSHED SYSTEMS

Over the last few decades hydraulic and hydrological models have dramatically increased our understanding of urban watersheds for infrastructure planning.

Combined with tools like the Internet of Things (IoT), Big Data Analytics (BDA), machine learning and advanced control theory algorithms we can now run high resolution models in real-time, with real world precipitation data, while controlling model segments with observed sensor data.

The outcome is perpetually calibrated digital copies of the urban watershed for far more effective real-time operational decision making and control. The reason this is so critical is that it enables us to fully understand a pumping network's recent performance and status, predict risks and define what is the best course of action.

Furthermore, these optimization models can be built to be self-learning and with a powerful memory so that after each wet weather event it can automatically recalibrate (if desired) to adapt to changing conditions and new infrastructure. The same platform can be designed to be bi-directionally connected to all critical assets (pumps, tanks and basins, gates and valves, tunnels and treatment plants) throughout the urban watershed via powerful edge computing networks. It can also simultaneously run multiple future exploratory models of infrastructure solution sets for planning considerations.

This approach greatly improves daily operations and provides an opportunity to absorb all institutional knowledge from operators, planning engineers and utility leadership. Perhaps best of all, Intelligent Urban Watersheds can generate hundreds of millions, and sometimes billions of dollars in capital improvement project savings by getting the highest performance, capacity utilization and resiliency from legacy infrastructure.

Stormwater management challenges like overflow mitigation, capacity increase with no new infrastructure, accurate and cost effective future growth, among others, can be addressed with these new data-driven models.

Analyze potential solutions by collecting and organizing the existing knowledge available in your network and create a decision support system on that basis. More information on our capabilities around this topic on page 100.

B | MAXIMIZE SYSTEM EFFICIENCY WITH SMART PUMP STATION DESIGN

One of the critical components of a sustainable pumping system is a well-designed pump station.

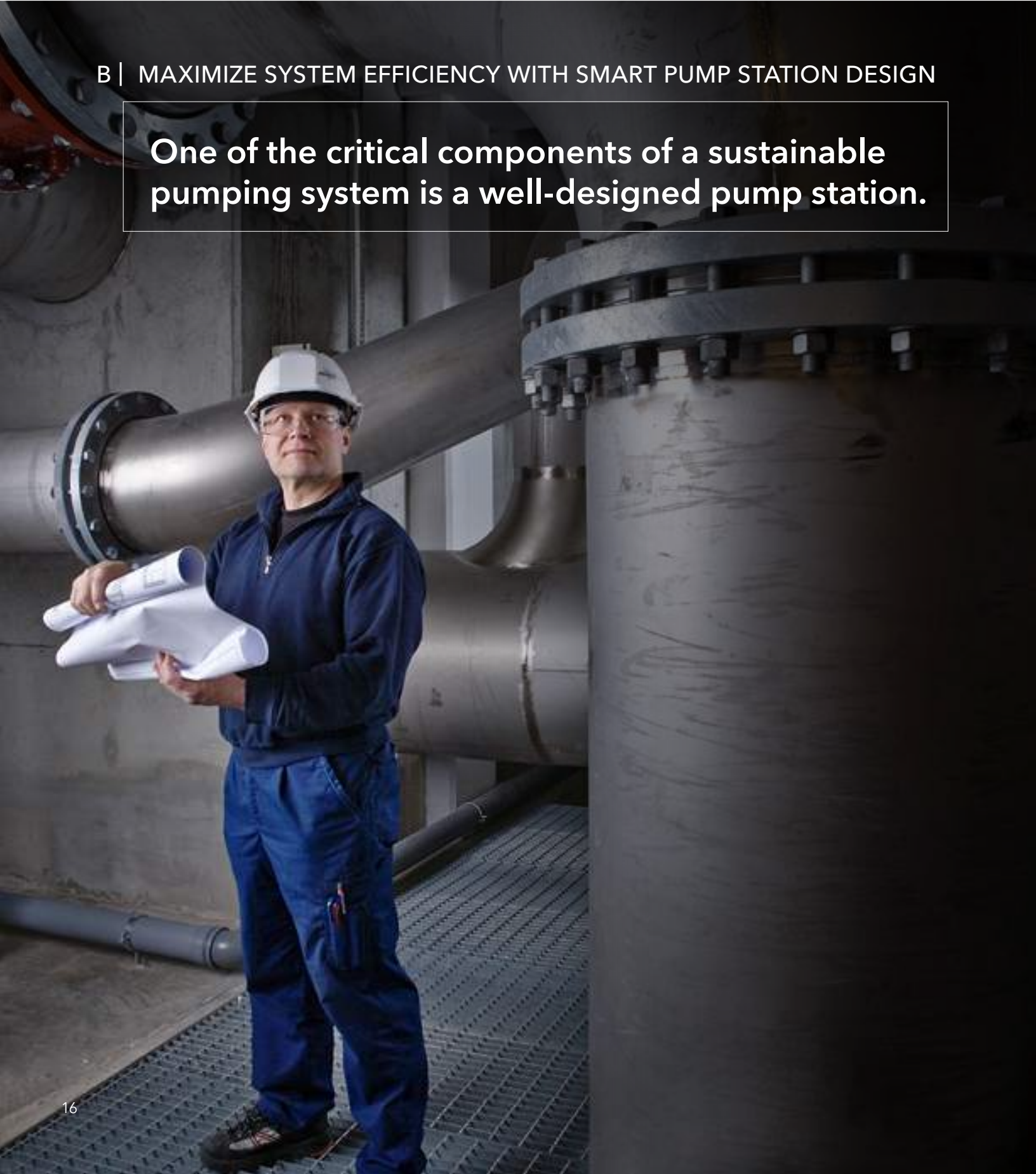



The right pump station will not only maximize the service life of the pumps, but also ensure reliable and efficient pump station operation. When designing a pump sump, it is imperative to provide the best possible inlet conditions for the pumps, while also minimizing sedimentation and reducing the pump station size.

Whether the pump station solution being considered is pre-engineered and packaged, a standardized design or a custom design, examine these factors to help ensure an optimal end result.

Evaluate the impact of the following factors and adjust your pump sump design accordingly on a case-by-case basis:

- | Number, type and arrangement of pumps
- | Variability of flow conditions in the area
- | Geometry of the structure
- | Pump control schemes
- | Access to equipment service
- | Other site-specific factors

## B1

### DESIGN GUIDELINES FOR STORMWATER PUMP STATIONS

According to the National Weather Service, New York City experienced over 1,000 millimeters (42.17 inches) of rainfall in 2016.<sup>6</sup> Roughly 4,800 kilometers (3,000 miles) away, Seattle averages around 950 millimeters (37.5 inches) of precipitation a year.<sup>7</sup>

In urban areas like these two cities, stormwater pump stations are typically designed underground and used to transport collected runoff water and stormwater to a retention pond, treatment plant or dewatering channel. Because these stations must be able to handle very high flows in relatively short periods of time, every element of their pumping systems needs to be specifically designed to operate under extreme conditions.

If the stormwater is going to be treated, or if expected volumes are higher than the pumping capacity, combine stations with detention tanks to improve flow management.

Like any pump station, the design of a stormwater station must comply in everyway with the general recommendations from the main standard groups like Hydraulic Institute (HI).<sup>\*</sup> Stormwater stations must also be able to prevent adverse hydraulic phenomena and maintain flow and flood protection. Some of the most common adverse hydraulic phenomena are listed below.

<sup>6</sup> <https://www.weather.gov/media/okx/Climate/CentralPark/monthlyannualprecip.pdf>

<sup>7</sup> <http://www.seattleweatherblog.com/rain-stats/>

\* HI Section 9.8 provides specific recommendations regarding intake design.

## Adverse Hydraulic Phenomena

### Excessive Pre-swirl

Can influence efficiency and performance, create cavitation and vibration.

#### Hydraulic Institute Performance Criteria

Velocity angle < 5 degrees

Angular momentum < 3 %

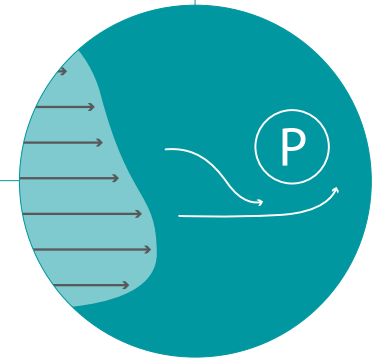

### Uneven Velocity Distribution at the Pump Intake

Can influence efficiency, create noise and vibration bearing wear and pulsating discharge.

#### Hydraulic Institute Performance Criteria

Velocity distribution +/- 10%

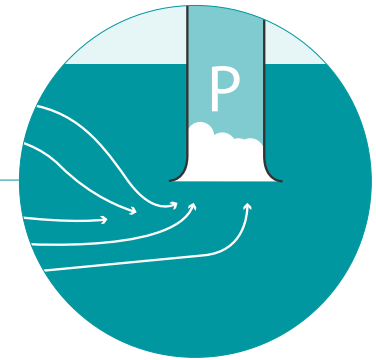

### Vortices

Will create cavitation, uneven load noise and vibration.

#### Hydraulic Institute Performance Criteria

Guaranty that Type-3 vortices and above are avoided

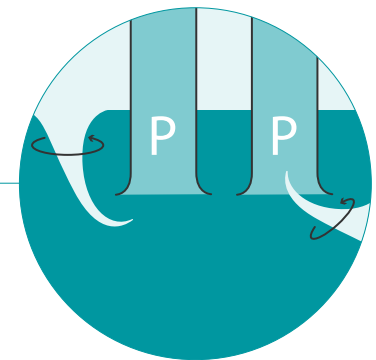

### Entrained Air

Can influence efficiency, create cavitation and lead to corrosion of the impeller and vibration.

No air shall enter the pump inlet. Inlet pipes shall be located as low as possible and air shall have sufficient time to bubble up

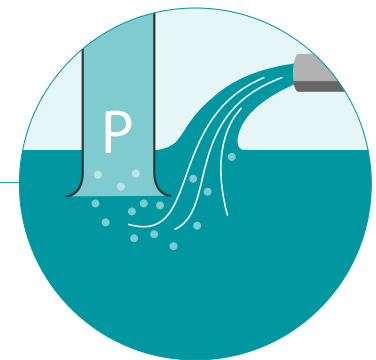

## B2

### ACCOUNTING FOR THE SEDIMENTATION OF SOLIDS AND FLOATING DEBRIS

In addition to preventing adverse hydraulic phenomena, designers of stormwater pump stations must consider the risks posed by the sedimentation of solids in the sump area and the buildup of floating debris on the surface.

#### Sedimentation of Solids

Creates costly, time consuming cleaning and high risk of pump clogging or even damaging the pump.

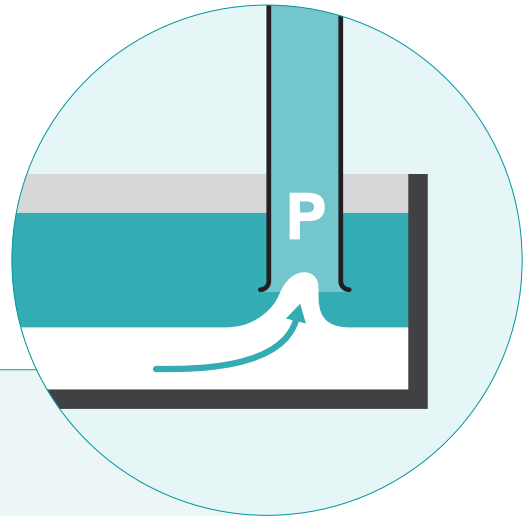

#### Floating Debris

Creates odors, costly, time consuming cleaning and high risk of pump clogging or even damaging the pump. Risk of incorrect or impossible level control.

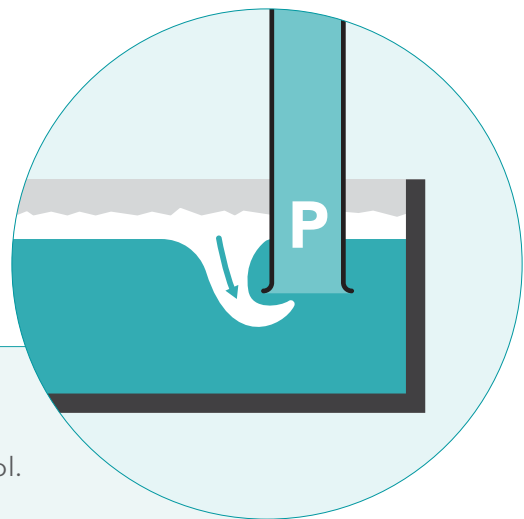

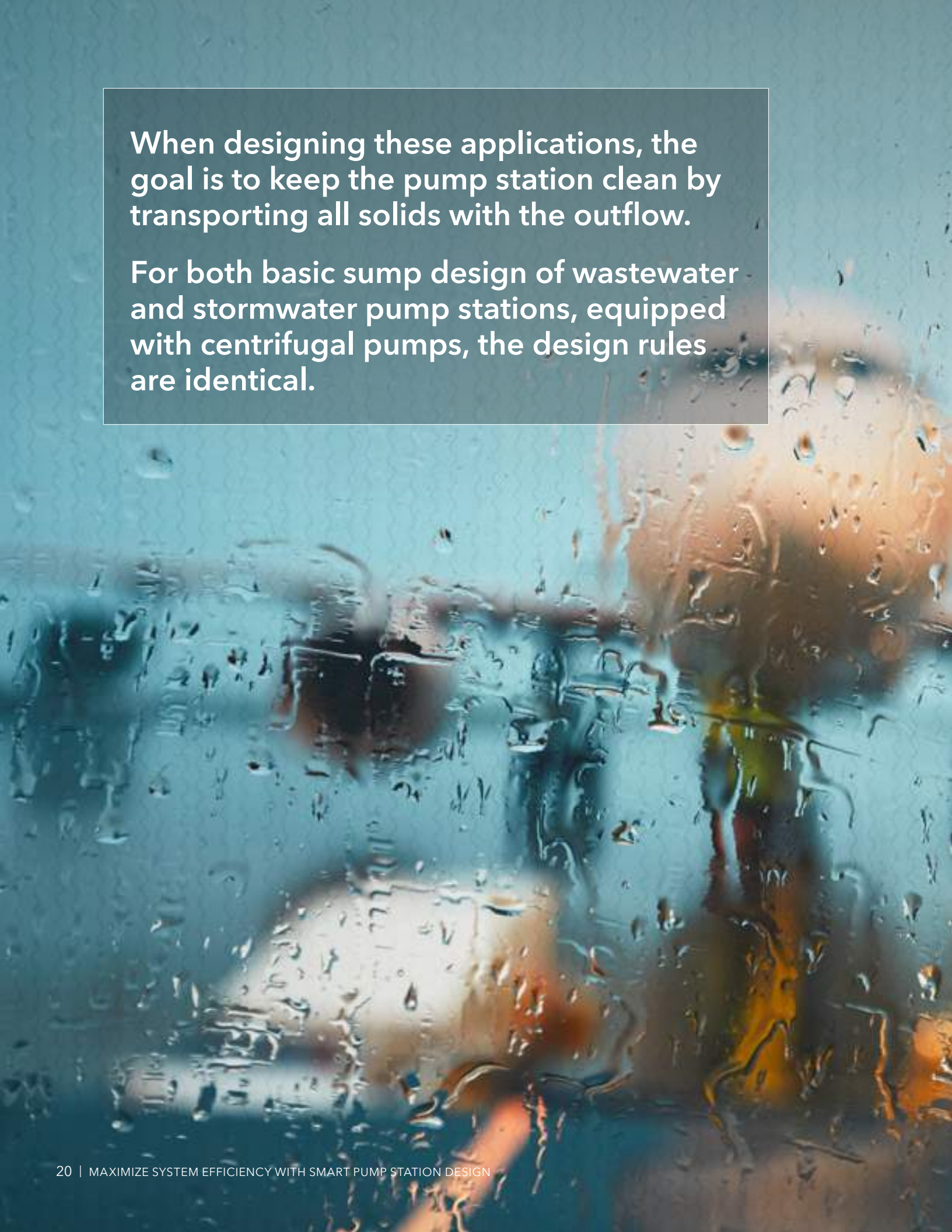

When designing these applications, the goal is to keep the pump station clean by transporting all solids with the outflow.

For both basic sump design of wastewater and stormwater pump stations, equipped with centrifugal pumps, the design rules are identical.

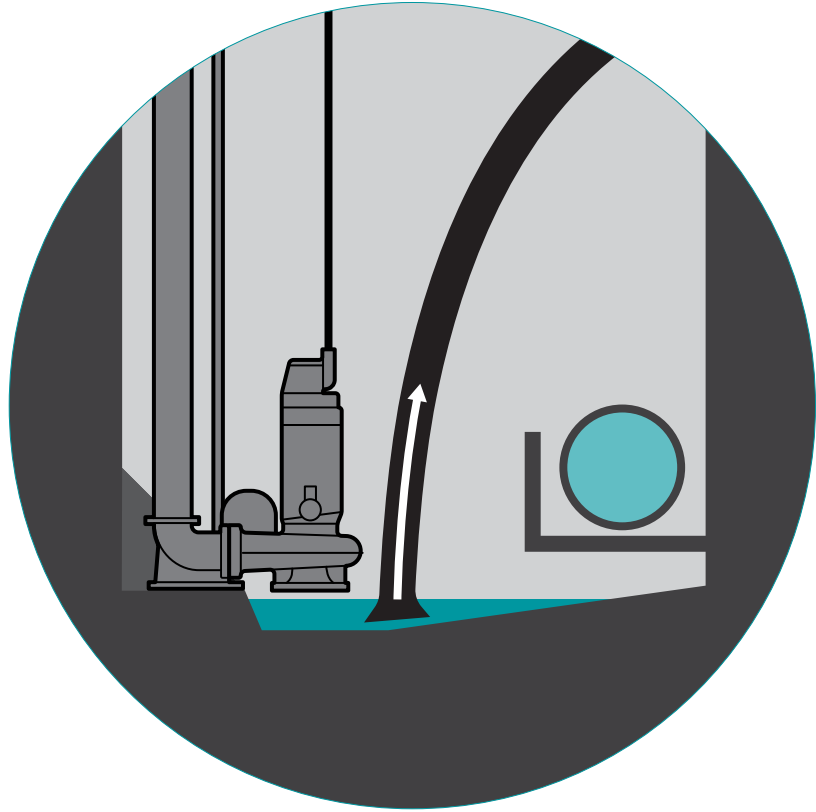

## Drain Pump

Stormwater stations can be inactive for long periods and should be able to be drained of water when not in use.

This can be done either by a drain pump installed in the station or by a vacuum truck. If a drain pump is used, it is best practice to install it at the lowest point in the station as shown above.

## B3

EXAMINING SPACE *VERSUS* CAPACITY

Large stormwater stations are usually required in areas characterized by large impermeable surfaces, heavy rains and the presence of infrastructure or equipment for which a flood would cause serious consequences.

But locations in urban areas often require efficient flood prevention systems in a limited amount of space. The principal challenge, then, becomes finding a way to locate and design a sustainable stormwater station in a crowded area.

Severe consequences can arise from having an underperforming pump station in a heavily populated city, especially in climates where large volumes of rainfall can accumulate. This is why stormwater stations are normally sized to manage a peak flow from a storm that might only occur every 10 to 50 years.

Space is often one of the greatest challenges to pump station design in developed urban areas.

In these environments, your top priority should be making the pump station as functional and compact as possible. Achieve this by adopting specific features to maximize efficiency in a minimal amount of space.

Baffle walls, flow guiding channels, and formed suction intakes for axial flow pumps are a few examples of space-saving measures design engineers can implement to minimize the footprint of a stormwater pump station.

The following example of a compact design for a pump station includes some of the adaptations discussed above.

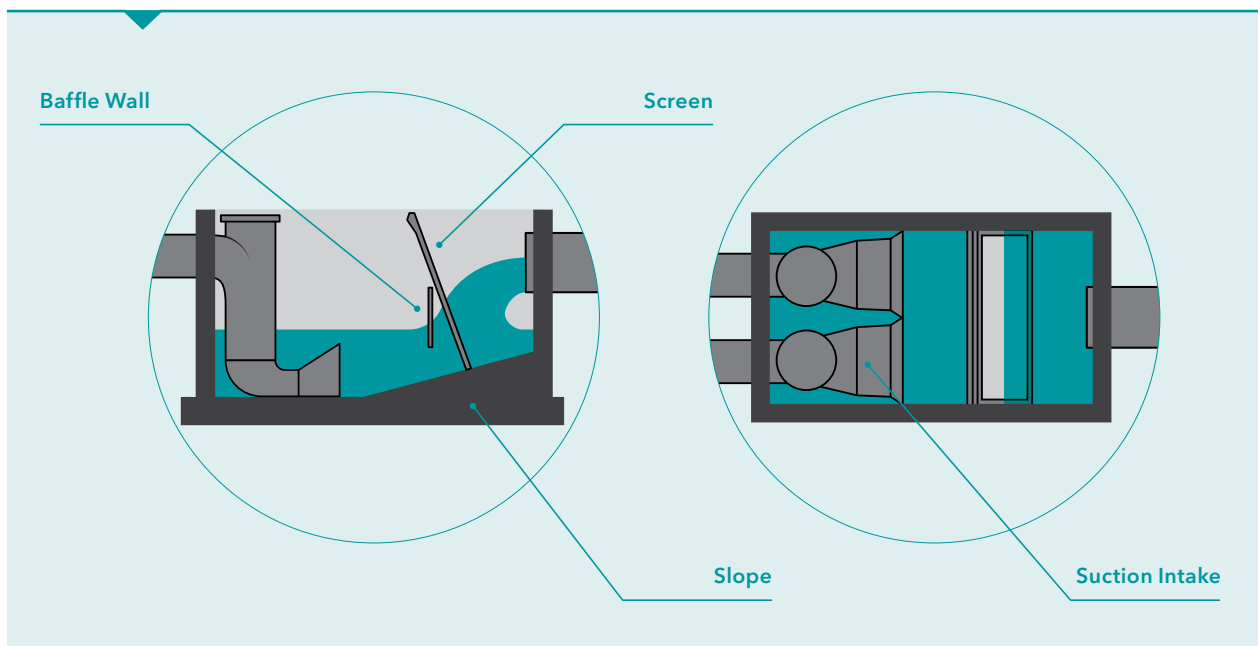

## B4

### CONSIDERING THE BENEFITS OF A FEW LARGE PUMPS *VERSUS* MANY SMALL PUMPS

A key decision when designing a stormwater station is whether to use a few large pumps or many small pumps. As the required flow for a station increases, it may become necessary to consider the benefits of choosing very large pumps.

Large pumps tend to be customized and can be particularly efficient. But because they are tailored for a specific installation case, they can have specific sump design and screening requirements. Design engineers must take great care to ensure the station design complies with the pump manufacturer's requirements. In general, using large pumps can result in a smaller pump station; and having fewer pieces of equipment can reduce maintenance costs. On the other hand, large pump maintenance requires thorough planning and experienced personnel.



Large pumps tend to be customized and can be particularly efficient.







There are two distinct advantages of designing a station with many small pumps: flexibility and redundancy.

While it can be tricky for a large pump to operate at low flow rates, a station with many small pumps can operate in a wide range of scenarios and adapt easier to varying flow conditions.

Furthermore, a significant portion of the station's capacity can disappear if one large pump stops operating, whereas losing one pump may only have a minor impact on a station with many small pumps.

In some cases, there are benefits to designing pump stations that combine a few large pumps and small pumps.

If implemented correctly, this design makes it possible to cover a vast spectrum of flows, achieve near-optimal pump efficiency, prolong pump lifespan, and minimize operating costs.

## B5

### EVALUATING THE ADVANTAGES OF SUBMERSIBLE PUMPS *VERSUS* DRY INSTALLED PUMPS

In addition to coming in different sizes, pumps in a stormwater station can either be dry or submerged.

Pumps installed submerged, can easily be used in one area, with all the components –pump, piping and water- all located in a wet well. Dry installed pumps are located in a dry area connected to a wet well via pipes.

#### THERE ARE TWO TYPES OF DRY INSTALLED PUMPS

### Submersible | Dry motor (non-submersible)

The location of these pumps in a dry area enables them to be maintained on the spot, and offers easy lifting and cable management solutions.

The drawback is significant upfront costs associated with the construction of a larger dry sump to house all the equipment. If non-submersible pumps are used, dry well flooding poses a significant additional risk – a very real possibility considering many stormwater stations are susceptible to flooding during their operating life.



## Submerged Installation with Submersible Pumps

### ADVANTAGES

- Allows for the construction of a much smaller station
- Uses submersible motors with no concerns about damage in the event of flooding
- Motor is connected directly to the pump without intermediate shafting
- Located underwater, and out of earshot, which lends itself nicely to densely populated areas
- Tends to be designed to handle sewage, so it won't become inoperable due to blockage over time. This can facilitate larger screen openings and reduce operating and maintenance costs

### DISADVANTAGES

- Lifting, working on and managing the cables for a submersible pump must be considered and accounted for with proper devices and accessories especially in very deep stations
- Processes and equipment must be on site to handle retrieval, cleaning and maintenance

## Dry installed pumps with no intermediate shafting are easy to maintain

(long-shaft long-coupled and compact closed-coupled type)

### ADVANTAGES

- Dry installed pumps are easy to maintain
- Can be quickly replaced if motor repair is needed, with correct aligning
- These advantages are achieved with dry installed submersible pumps as well.

### DISADVANTAGES

- Greater concern about flooding of the dry well
- Motor must be installed high above the pump to protect from flooding
- Risk of vibrations as motors are connected to pumps by a long shaft on long-coupled Traditional Dry-Pit Pumps (TDPPs)
- TDPPs are not as compact as Submersible pumps, potentially increasing station size and footprint
- Large TDPPs are often not designed to handle heavily debris-laden flows
- Extra cooling may be required when ambient temperature is high

When it comes to station design, both pump types result in the same concerns. These include ensuring good hydraulic design, maintenance considerations, as well as correct screen sizing.



MORE INFORMATION IS AVAILABLE IN THE PUMP SUMP DESIGN RECOMMENDATIONS MANUAL.

## B6

### MANAGING DEBRIS

Handling debris is one of the major challenges for a stormwater pump station. Depending on conditions and resources, incorporating coarse screens or sand traps into the design can help prevent debris from entering the station. An alternative option is allowing debris in and using a slope and a sewage pump to transport it out of the station.

Evaluate the specific challenges and needs of each application when considering potential solutions. Consider consulting experts to aid you in designing the most reliable, tailored solution.

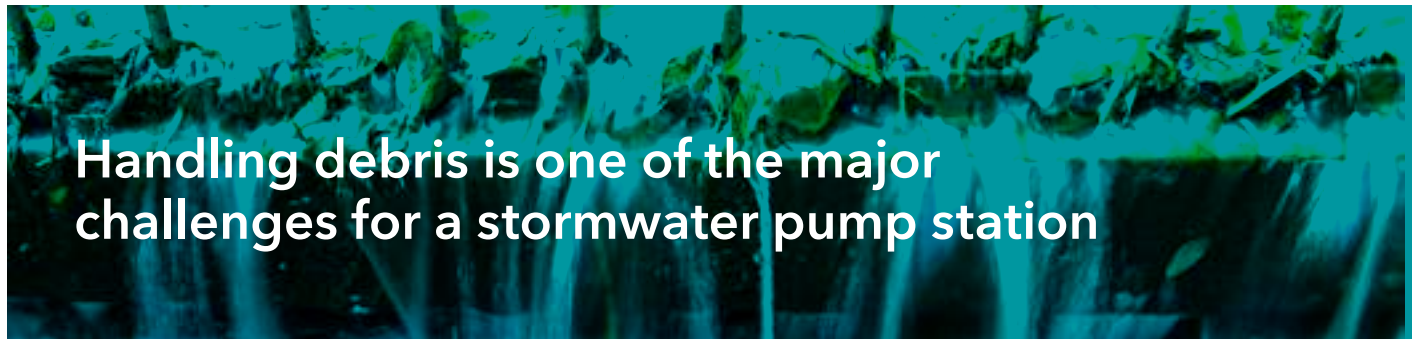

### Sedimentation of Solids

During heavy rain, a lot of debris is flushed from the surrounding areas and into the storm drains (gutters) and sewers, ending up in the pump station. This can lead to situations such as the one shown in this picture.

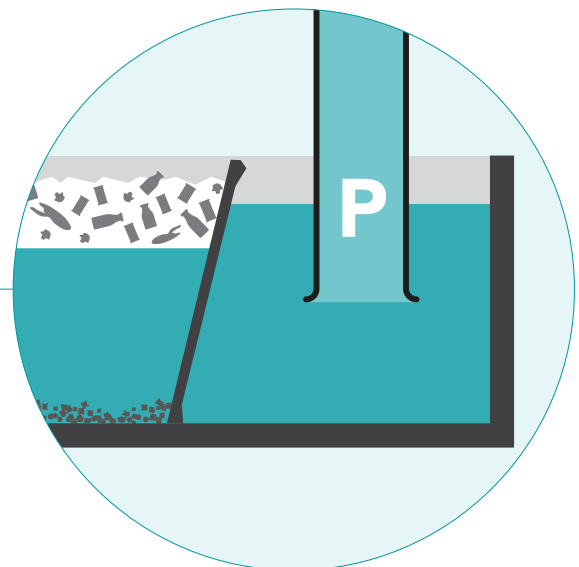

## Screens

Screens, which are normally made up of vertical bars with gaps, are used to prevent large objects from passing through. They ensure reliable operation of stormwater pump stations and help remove large solids from wastewater.

**In stormwater stations that pump out directly into a body of water, it is crucial for as little debris as possible to be transferred into the environment.**



Choosing the right screen size requires finding the perfect balance between functionality, pump requirements and economics.

In addition to preventing debris from entering the environment, screens can also help eliminate blockages that may prevent pumps from operating as intended—or even cause an overflow that floods the area the station is supposed to protect.

The tighter the screen clearances, the less debris that enters the pump station. Maintaining this type of screen requires reliable, usually automatic, cleaning. If screens get blocked, water levels downstream may become too low for pumps to operate effectively.

A problem of high velocity will occur if the screens are partially blocked in an asymmetrical way, which may cause an uneven distribution of velocity at the approach to the pumps and result in adverse inflow conditions such as a pre-swirl. Another issue that may occur when flow cascades over partially blocked screens is air entrainment.

### Standards in Screen Sizing

- | The minimum space between the bars of a screen should be large enough to prevent the velocity from becoming higher than the acceptable limits in the open area. Screens can create very poor hydraulic conditions in a pump sump. In some cases, screens may create problems for the pumps they are meant to protect. For example, a blocked screen can cause the velocity in the rest of the screen area to increase, leading to jets of high-velocity water being sent into the pumping station. These jets can cause issues related to uneven velocity and rotational flow patterns (swirl) at pump inlet. Furthermore, debris blockages can cause a level difference between the upstream and downstream sides of the screen and result in severe pump issues such as vortices and insufficient net positive suction head (NPSH) leading to cavitation. Screens that clog regularly should be prioritized for manual or automatic cleaning.
- | The screen opening required by a pump should always be checked with the pump manufacturer. Openings should be selected based on this capacity and the capacity of the piping network of the system.
- | More metal is needed to make screens with smaller gaps, which is why the costs of these screens are typically higher. The smaller the gaps in a screen, the more cleaning is required and the higher the maintenance cost will be. Screen cleaning usually involves using long rakes to pull debris to the top and deposit it into appropriate waste containers, which can be challenging for workers at deep stations. Automatic cleaning offers an advantage in designs where trash is constantly moved up the screen, but costs more than manual cleaning. In some severe situations, screens may have to be removed entirely but doing so is not recommended if it can be avoided.

An alternative to screens can be used in combined stormwater and sewer pumping stations that contain high flow pumps capable of passing adequate amounts of solids. In this case, proper pump placement can transfer solids to a wastewater treatment plant to be handled by the facility's primary screening capabilities.

For pumps that release water directly into the natural environment, instead of into a detention facility that stores water for later treatment, place pumps at a higher level behind a weir wall to change water flow characteristics and reduce the risk of debris reaching them.

## Sand Traps

Like debris, sand presents another major concern for stormwater pumping in some areas. Sand can accumulate in stations, causing premature wear and tear to equipment. It can also collect in pipes, causing increased losses, and if contaminated, it may also be hazardous to the surrounding environment.

There are two different methods for dealing with sand:

PUMPED AWAY

COLLECTED IN A SAND TRAP OR A SEPARATE DEVICE SUCH AS A STORM FILTER OR BIO-FILTER

Trying to pump the sand out of the station is the best practice for stormwater stations that pump to a treatment plant with a process in place for separating and sorting solids.

These stations should be designed to maintain relatively high velocities to keep the sand suspended. High discharge piping velocities help ensure the sand doesn't settle during transportation. The design of the sump is of crucial importance in this type of solution, as the size of the station prevents low velocity areas where sand can accumulate. If a station is exposed to large amounts of sand, materials with high abrasion resistance, such as alloys with high chrome in rotating parts, should be considered.

A sand trap is a traditional design that slows down the flow of water to allow sand to settle. This design collects sand in a designated location, and prevents most of it from being transported further down the flow path.

Sand traps operate on two very basic principles: EFFLUENT VELOCITY AND SETTLING VELOCITY.

By controlling the length and width of the area it is ensured that a given percentage of sand will settle before leaving the designated trap area. This type of sand trap can be used in areas where ample space is available, but isn't a viable solution in areas with minimal space for sand collection.

Particle size is a key factor in sand traps. Large particles, such as gravel, have a significantly higher settling velocity than smaller particles, such as silt. A standard stormwater station will typically only have enough space for a sand trap that can capture larger particles and debris at the beginning, while finer particles pass through to the end. Sand traps can either be cleaned manually or by installing a system with a mixer that stirs the sand into suspension and a pump that transports the sand and water to a separate discharge location.

If minimal space for handling sand is available and other items cannot be pumped out into the environment, commercial solutions can be implemented, as well as for oil and biological pollutants. These small, self-contained stations – usually called storm filters, separation filters or bio filters – are usually installed in manholes in front of a pump station.

They can be designed to collect and separate many different types of materials, and screen out particles to a required size. They are also easy to clean and can quickly be emptied after a storm event and replaced in time for the next one.

They also include a bypass feature so, if the station becomes contaminated to the point where the filter, screens, or other devices no longer function, the water will continue through untreated, instead of flooding the surrounding area.

Although these solutions come with an associated cost, they are useful due to their compact size and innate ability to handle different kinds of debris.

They are especially valuable in areas where the stormwater pump station discharges directly into the environment.





## B7

### UPGRADABLE STORMWATER PUMP STATIONS

Constant changes in storm frequency and rapid urban development have created a dynamic environment, in which flexible solutions have become a necessity. Upgradable pump stations provide a solution that is both effective at the time of installation and adaptable in the event of more demanding future conditions.

This alternative is particularly useful in cities that are still developing. As buildings and infrastructure evolve and grow and storm frequencies and water flows fluctuate, the design of these stations allows for the easy installation of different pump sizes and extra pumping capacity.

Some examples of upgradable stormwater pump stations are shown in the figures below.

This dry installed pump station is built for a future flow capacity increase. The wet well section can be closed off with gates or temporary walls until the extra capacity is needed.

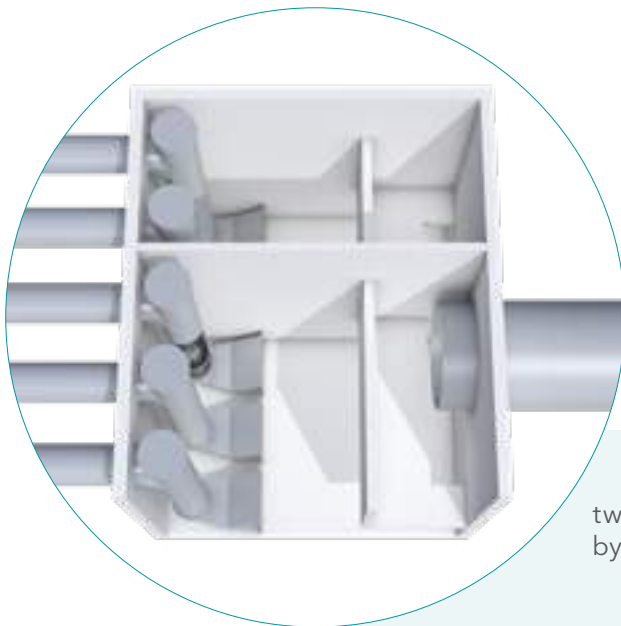

In this wet installed propeller pump station, two pipes are separated from the rest of the station by the use of a temporary wall. When all five pumps are needed, the wall can be removed.



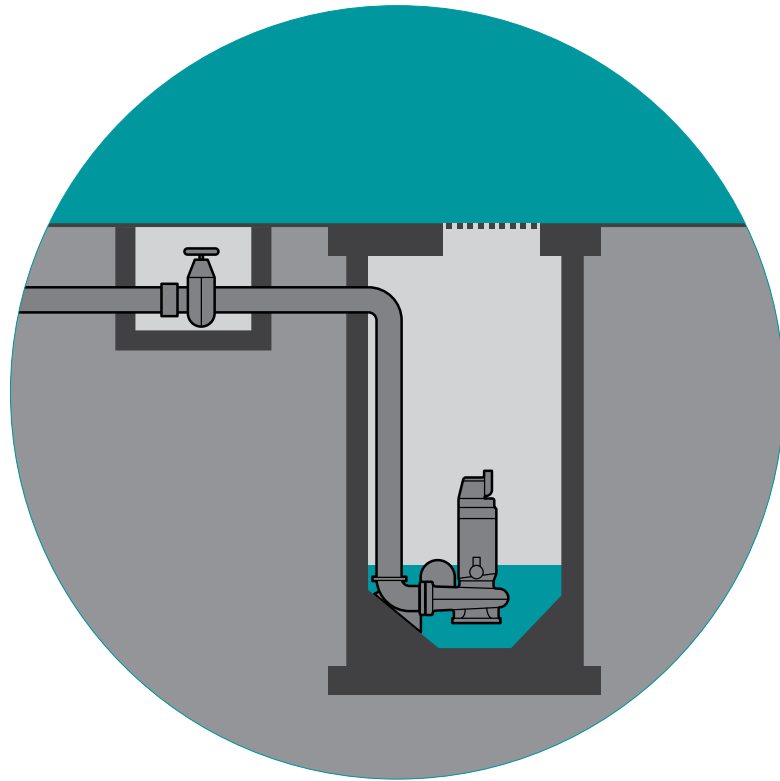

## B8

### PREFABRICATED STORMWATER PUMP STATIONS

The correct pump station design is critical to operational reliability. Choosing the right design keeps the station free from sedimentation and sludge buildup, prevents the occurrence of safety hazards for staff and ensures the station works properly.

Prefabricated sumps reliably reduce the buildup of solids and sludge. Their optimized geometry, minimal rest volume and self-cleaning capabilities ensure the continuous functioning of pump stations equipped with these sumps. With a smaller floor area than standard sumps, prefabricated sumps collect sediments directly beneath the pump, where suction is the strongest, which improves reliability and reduces maintenance costs.

Furthermore, these stations are easy to install, which is particularly important in urban areas where disturbances need to be minimized.

## B9

### COMBINED STORMWATER AND SEWAGE PUMP STATIONS

In addition to the challenges of pumping wastewater, combined pump stations must handle large flow variations between normal flows and flows from a storm. Large flows require a large pump sump to ensure the necessary hydraulic conditions for the pumps.

But large sumps also allow sediment to build up, which occurs mostly during dry periods when low sewage inflows don't create sufficient velocities to transport solids out of the sump. These buildups are costly to clean and can result in gas formation problems that cause corrosion and foul odors. If buildups break free during a storm event, they can block the pumps when they are needed the most.

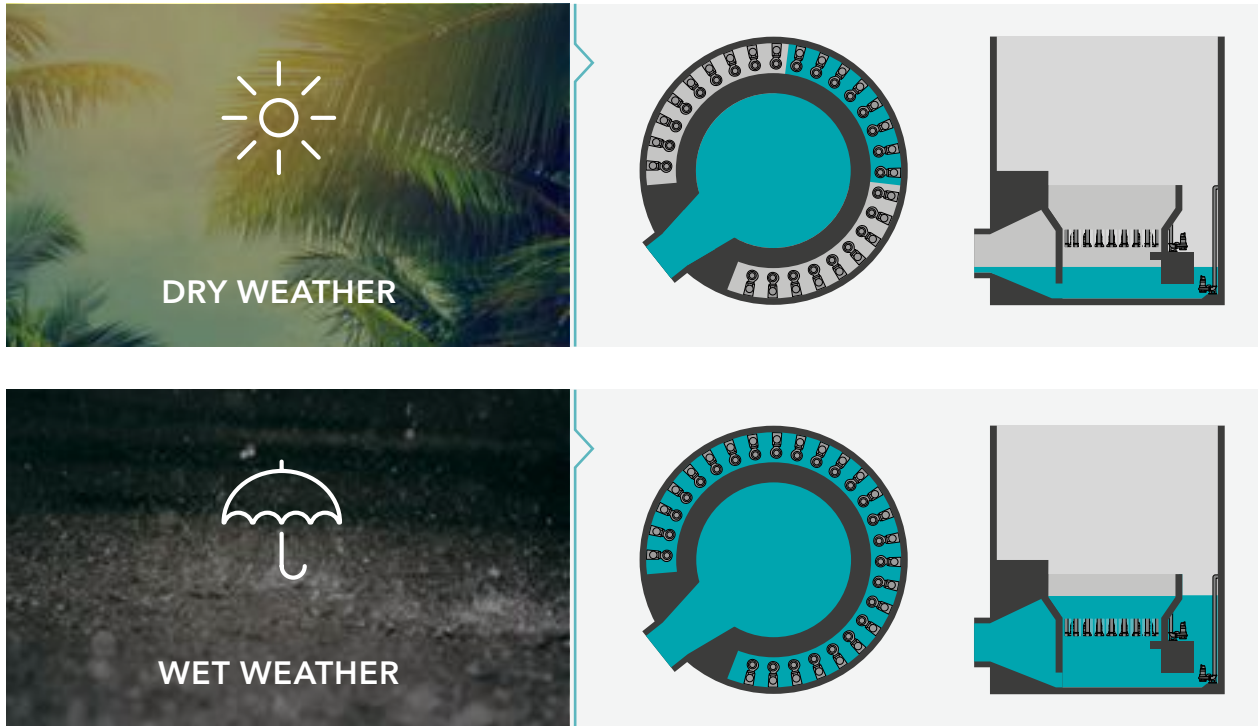

The pumps installed at the upper level work only when the level rises due to high inflow. When the flow returns back to the normal daily flows, the water level will drop and the pumps will no longer be submerged. If they are installed at same level as the normal wastewater pumps, there is a risk that they will be packed with solids when it's time to start pumping because of a possibility the pumps are not used for a long time.

Avoid these problems by dividing the pump sump into two or more chambers: one devoted to the daily inflow of wastewater and the other(s) used during storm events.

Placing pumps at different levels is another solution. This allows the sump to be divided vertically based on water levels, instead of using walls. In this case, each level acts as a separate "station," with lower pumps used for daily wastewater flows and elevated pumps used when liquid levels rise during extreme events.

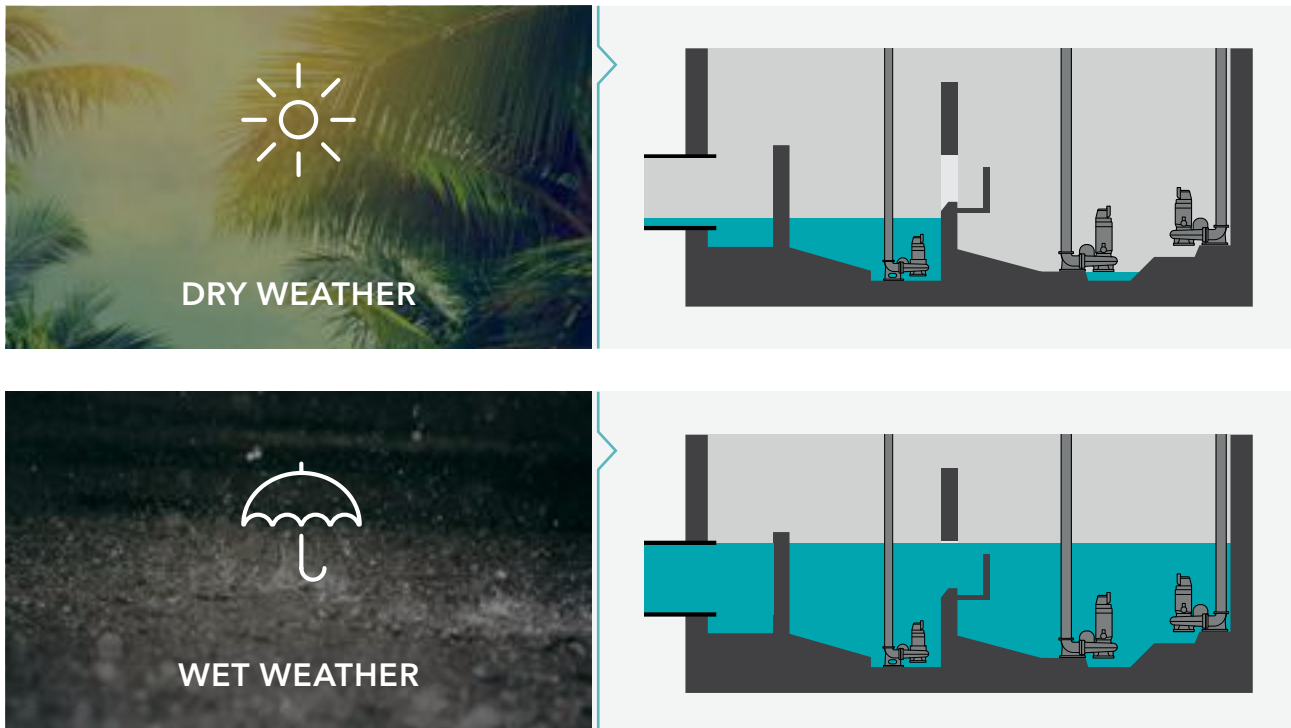

The pumps installed in the 1<sup>st</sup> sump handle the base flow during dry weather. The pumps in the 2<sup>nd</sup> sump to the right work only when the level rises due to high inflow. After the storm event when the water level drops the solids will be pumped away with the lower located pump. Together with special design of the sump bottom almost no sediments are left in the stormwater area.

C | XYLEM'S OFFER FOR OPTIMIZING SUMP DESIGN

Xylem offers specific services to help consultants and operators optimize the design of their stations.



Xylem offers specific services to help consultants and operators optimize the design of their stations and ensure reliable and efficient operations. Continue reading to receive a brief overview of these services, and contact your local Xylem office or visit [www.xylem.com](http://www.xylem.com) for more information.

## C1

### PUMP SELECTION TOOL | XYLECT

Web-based software Xylect, and corresponding mobile application Xylect Mobile, contain information and applications for pumps and other related equipment.

Both Xylect and Xylect Mobile include the following features:

- | Product search and selection
- | Technical and support documentation
- | Project management (i.e. storing pump selections)
- | Life Cycle Cost (LCC) calculations for projects
- | Friction head loss in pipe systems
- | Duty point guarantee
- | Variable speed analysis
- | Multiple pump system analysis
- | Consultant specifications

Additional information regarding specifications for pump stations and the Xylect pump selection program is available at [www.xylect.com](http://www.xylect.com). Simply select the pump and visit the section entitled "Consultant specifications."

## C2

### SYSTEMS ENGINEERING COMPUTER-AIDED DESIGN | SECAD

SECAD is Xylem's engineering software for designing wet wells or pump sumps for wastewater and stormwater pump stations using both centrifugal and propeller pumps. Typical flows range from 10 liters/second, (158 US gallons per minute) to 10,000 l/s (158,500 gpm).

In a well-designed wet well or pump sump, the pumps will:

1. MEET THE REQUIRED DUTY POINTS

2. MINIMIZE THE ACCUMULATION OF SOLIDS

3. OPERATE SMOOTHLY AND SAFELY, WITH:

NO NOISE OR VIBRATIONS

MINIMAL FLUCTUATIONS IN LOAD ON THE PUMP MACHINERY, PIPES, ETC.

Implementing a SECAD design reduces pump maintenance requirements and risk of overflow. A SECAD design also minimizes the footprint of a pump station and reduces investment costs. Ultimately, this results in low operating costs and the lowest total cost of ownership.



CONTACT YOUR LOCAL XYLEM OFFICE TO OBTAIN A COPY OF THE SOFTWARE.

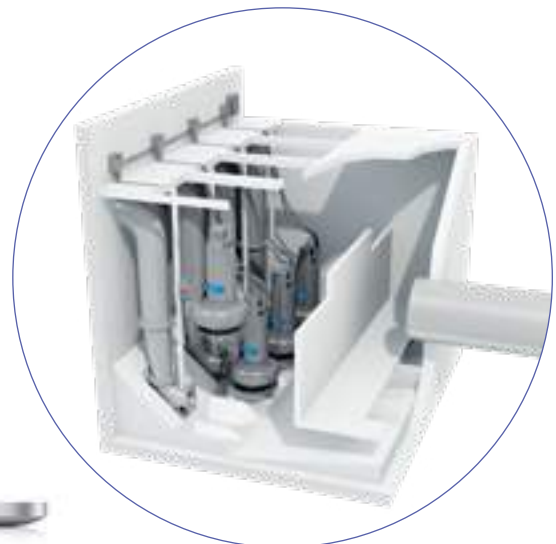



## C3

### COMPUTATIONAL FLUID DYNAMICS | CFD



Original Design

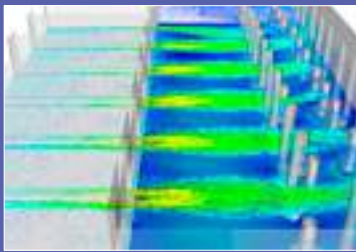

Original Design  
Simulated with CFD



New Two-Level Design

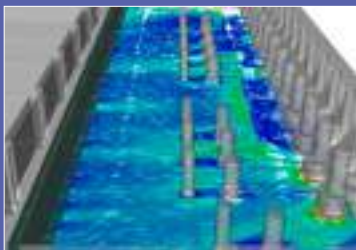

New Design  
Simulated with CFD

Sometimes standard pump station layouts aren't compatible with your site conditions. In these cases, Xylem can help design a customized pump station that meets your specific project requirements. These designs are made to handle various scenarios of inflow, minimizing the buildup of solids and arranging multiple pumping units to form an efficient, well-designed pump sump.

Xylem insists on using only the best commercially available CFD software. In fact, the software we use is also leveraged in other high-tech industries, such as aerospace, automotive, power, chemical and environment. We take great care to ensure that the numerical simulations are consistent with the measurable, physical reality that is typical for our applications. Because we have worked extensively with contaminated water, we have established ourselves as experts on this media and developed a unique understanding of the field.

We know, however, that even the best software isn't enough. Our studies are based on both our knowledge of the CFD system we implement and the insights we have gained from building a large number of stations addressing a wide range of unique contexts and requirements.

We use CFD to ensure that combined stations operate correctly in high and low flow conditions, small stormwater stations are of the necessary size to function properly and upgradable stations work optimally, both now and in the future.



CONTACT YOUR LOCAL XYLEM OFFICE TO OBTAIN INFORMATION ON THE CFD SERVICES WE PROVIDE.

## C4

### SCREEN DESIGN AND SAND CATCHING

Recommendations for screen design to maximize reliability and efficiency:

- | Check the screen opening requirements with the pump manufacturer.
- | Choose a minimum bar screen opening depending on pump size and type (e.g. 50 and 80 mm (1.9 and 3.1 in)). Xylem pumps are designed to handle solids of at least 60mm (2.4 in).
- | Ensure the maximum velocity between the bars is 1.7 meters/second (5.5 feet/second). The European Standard for Wastewater Treatment Plants (EN 12255) states that the maximum velocity between the bars for wastewater treatment should not exceed 1.2 m/s (3.9 ft/s).
- | Confirm the velocity in the inlet channel in front of the screen should not be less than 0.3 m/s (0.98 ft/s).
- | In regions with heavily polluted stormwater, install an automatic screen-cleaning system.
- | For deep inlet channels > 5 m (16.4 ft), and stations that may receive large amounts of clay and sand, deploy cable-operated bar screens to remove bulky screenings and sediment material. Include an intelligent programmable logic controller (PLC) to facilitate the removal of screening deposits by repeating the cleaning cycle from every position as often as necessary.
- | If the plant needs to be enclosed, use multi-rake bar screens. With their compact design, they fit right into the building. A large number of rakes have a high discharge capacity and can also be retrofitted. Multi-rake bar screens are a cost-efficient solution for medium sizes, with a very short cleaning cycle for large amounts of screening.

Consider the following liquid velocities to avoid sand sedimentations in sumps and pipes:

- | At 1.7 m/s (5.5 ft/s), all sizes of sand move at the same velocity as the water
- | At 0.7 m/s (2.3 ft/s), all sizes of sand particles move forward
- | At 0.2 m/s (0.7 ft/s), organic material starts to move

When stormwater is pumped to a treatment plant, sand and water separate in the sand trap at the plant. For this to occur properly, the velocity in the discharge pipe from the stormwater pump station to the wastewater treatment plant must be above 0.7 m/s (2.3 ft/s). Furthermore, the velocity at the bottom of the station should be above 1 m/s (3.3 ft/s).



FOR MORE INFORMATION ON MATERIALS OF CONTRACTION, PLEASE SEE XYLEM'S PUMP ASSORTMENT.

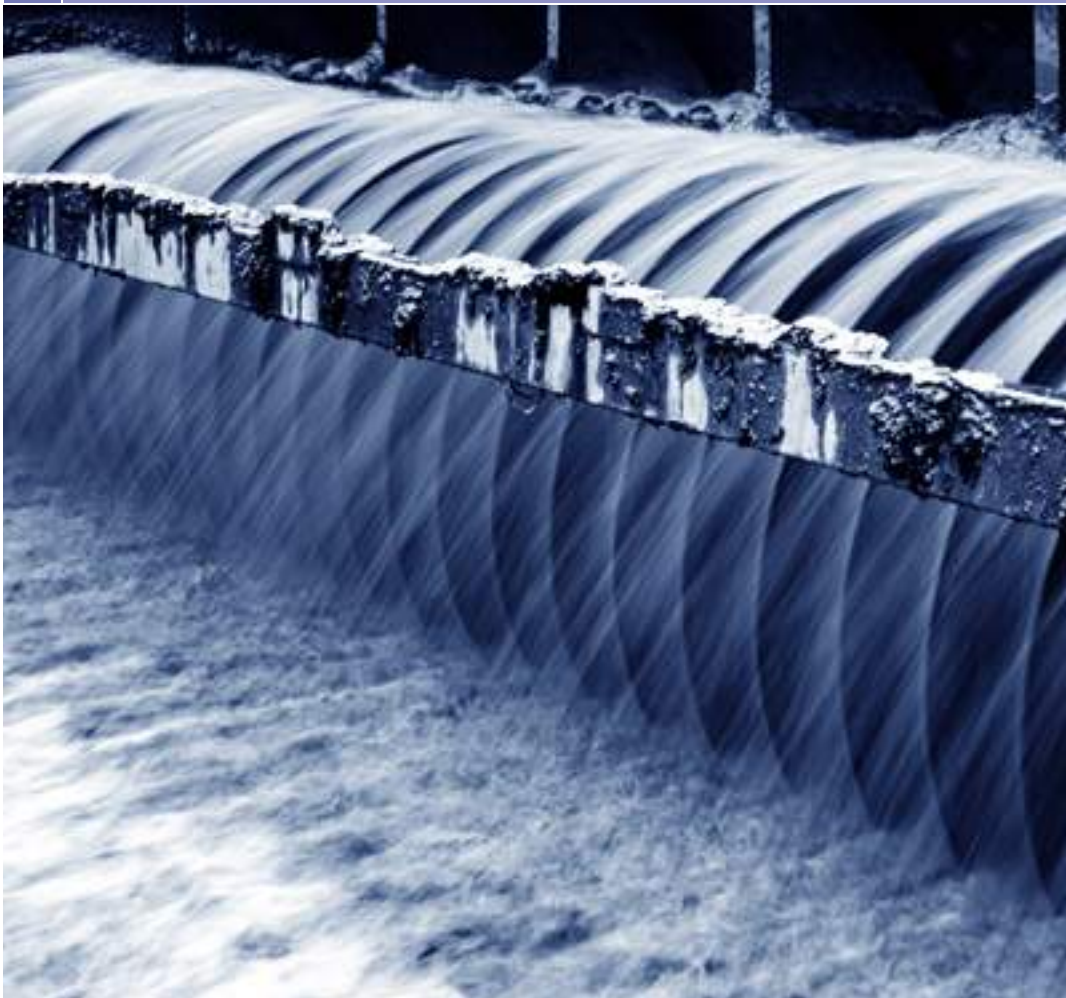

## C5

### XYLEM'S OFFER FOR PREFABRICATED SUMP PRODUCTS

#### TOP Station

The Flygt TOP sump bottom can be used to outfit new pump stations or to retrofit existing sumps. Its optimized geometry leaves no space for sludge to accumulate and the small remaining volume of water at the end of every pumping cycle creates high velocity in the sump. TOP stations combine this high velocity with turbulence to suspend sedimentation and pump the floating debris away.

The submersible pump is easy to install and remove for service. It hooks up automatically when lowered onto the discharge connection and disengages automatically when it needs to be lifted.

Twin guide bars secure correct positioning of the pump when it is hooked onto the submerged discharge connection. Integrated lower guide bars and sliding brackets ensure a perfect fit when the pump is lowered into position. The pump flange, or sealing gasket, slides vertically down along the discharge connection flange, while the robust metal-to-metal contact between flanges allows the pump to clear away any debris that may get caught and cause leakages.

## C6

### CAPACITY AND HYDRAULICS OF XYLEM'S PUMP SERIES

This section provides background information on the various pump series solutions Xylem offers. For each pump series, we have provided a graph of pump performance contours and information on flow, head, power, installation, suspended solid, abrasion resistance, PH and salt.

#### N Pump Series

##### CAPACITY

Flygt N-technology boasts a flexible, modular hydraulics design that can be tailored to meet the requirements of virtually any application. Stormwater can contain large amounts of sand, grit and other abrasives and in this case it is strongly recommended to equip the N-pump with a wear-resistant material impeller.

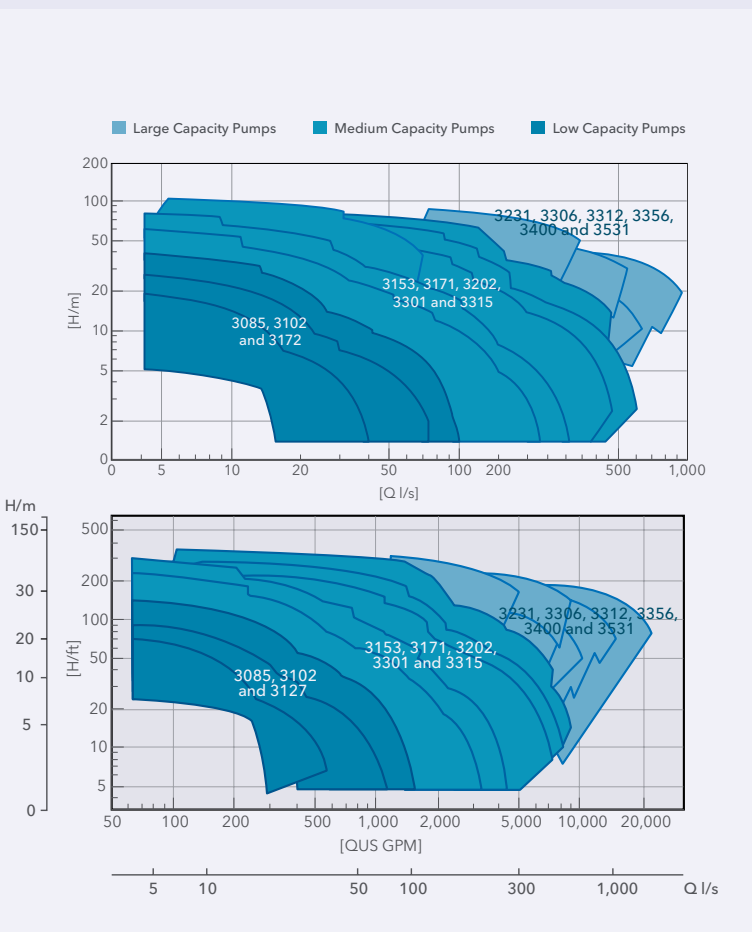

Choose a hardened chrome alloyed cast-iron impeller for wastewater and stormwater pumping applications, and the chopper version for your toughest applications involving long fibers and heavy solids.

We highly recommend specific hard-iron alloy impellers for all applications involving sand, grit and other abrasives, as well as mixed wastewater and seawater. Explosion-proof versions are available for all the assortment.

Xylem also offers impellers in duplex stainless steel for highly corrosive wastewater environments.

### Adaptive N™ Groundbreaking clog-free technology

The cutting-edge Adaptive N impeller and Adaptive N hydraulic technologies combine a unique geometry, dual-blade impeller and other patented features to deliver sustained high-efficiency and smooth operations. The unique design enables self-cleaning and up to 25% lower energy consumption, independent of impeller speed and duty point. It also minimizes vibrations, which results in a longer lifespan for mechanical components.

## N Hydraulics

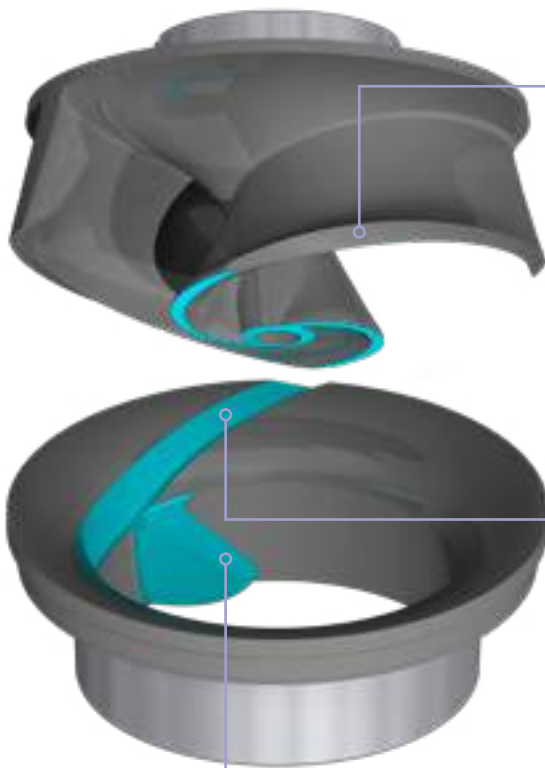

### 1. BACKSWEPT LEADING EDGES

#### Ensure no Sticking

When solids enter the pump, they are met by our dual-blade N impeller. The optimized blade geometry, with its horizontal machined backswept leading edges, ensures that no material sticks to the impeller.

### 2. RELIEF GROOVE

#### Facilitates Transport

When solids arrive at the perimeter of the inlet, they are transported inside the relief groove, guided along the edge of the impeller vane, through the volute and out of the pump.

### 3. INTEGRATED GUIDE PIN

#### Clears the Center

Integrated into the insert ring, a guide pin clears the center of the impeller by pushing solids along the leading edges towards the periphery of the impeller for removal.

4.

#### ADAPTIVE N™

##### Lifts Up for Large Objects

When larger objects enter the pump, the impeller lifts up due to the forces from these solid objects passing through. This avoids clogging and assures continuous, energy-efficient pumping.

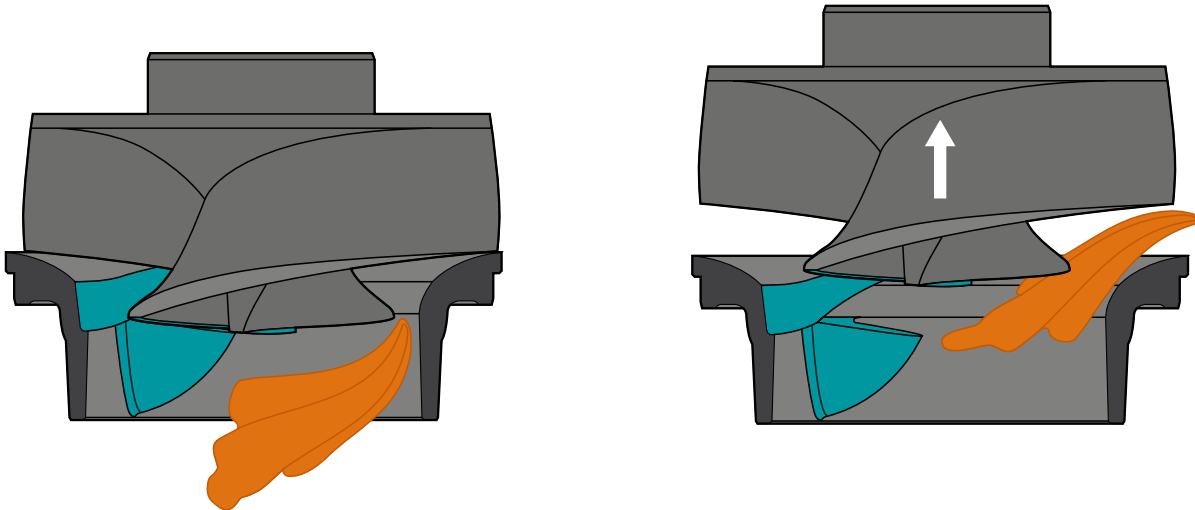

## PL Pump Series

### CAPACITY

Flygt Propeller pumps are optimized to pump large volumes at low heads. They provide a cost-effective alternative to centrifugal wastewater pumps. This portfolio of propeller pumps features a wide range of options designed to handle anything from 100 to 7,000 l/s (1,585 to 111,000 gpm).

### Hydraulic Features

N-technology ensures maximum reliability and sustained high efficiency. The suction of the pump is sealed with a replaceable rubber seal on the pump seat. Pump performance includes all losses (including column losses) of at least 500 mm (20 in) above the top of the motor.

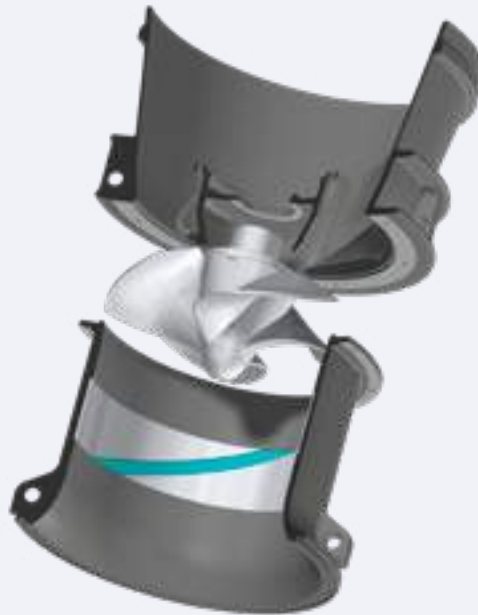



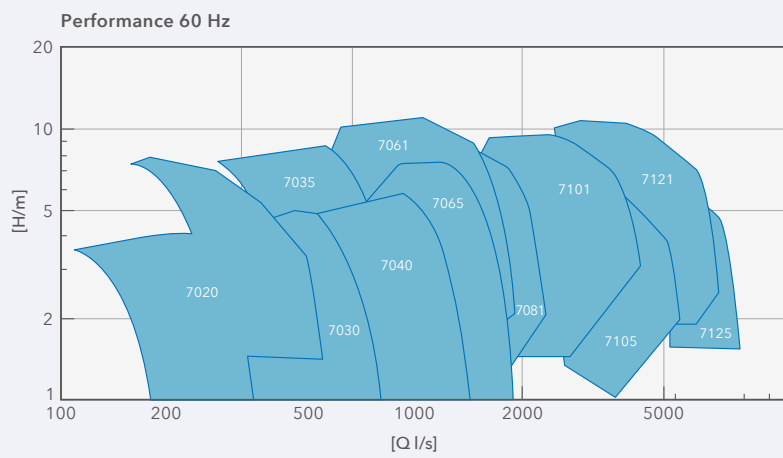
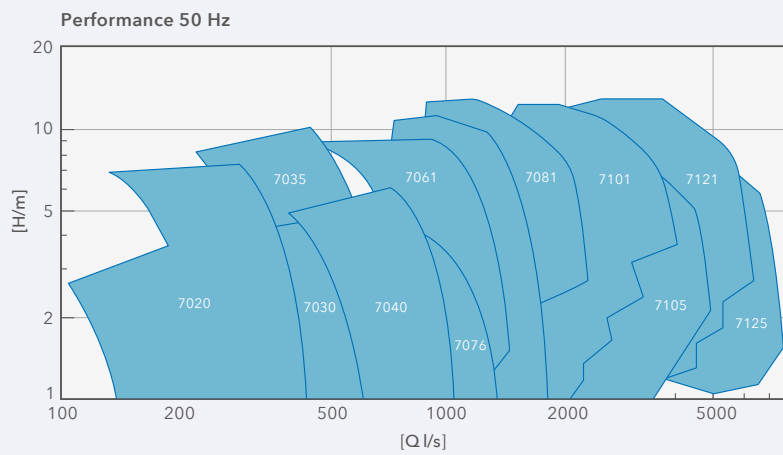



Two stations built side-by-side in one sump design saves Des Moines, Iowa \$1.2 million in construction costs.

**FAST FACTS**

**LOCATION**

Des Moines, Iowa, USA

**CHALLENGE**

Designing and constructing a high-rate combined sewer overflow treatment facility to prevent untreated wastewater from being discharged into the Des Moines River

**APPLICATION**

Combined Sewer Solids Separation Facility (CSSSF)

**TOTAL STATION CAPACITY**

390 MGD

**PRODUCTS**

Flygt CP 3501 and Flygt PL 7121 pumps with Formed Suction Intake (FSI)

## CASE STUDY: Des Moines Metropolitan Wastewater Reclamation Authority

### CHALLENGE

The Des Moines Metropolitan Wastewater Reclamation Authority (MWRA) is in charge of recycling wastewater and hauling liquid waste from 17 metro area municipalities, counties and sewer districts. It includes a conveyance system, which connects each of the MWRA's members to a wastewater treatment plant. Previously, severe storm events caused untreated combined sewer overflows (CSOs) to be discharged into the Des Moines River.

To better protect the public health of 500,000+ residents and improve the environment, the MWRA needed to design and construct a Combined Sewer Solids Separation Facility (CSSSF) that could treat CSO flows at a high rate during wet periods.

### SOLUTION

The MWRA engaged Xylem to provide technical support in evaluating potential sump design concepts. Xylem's engineers recommended a single sump design and the construction of two adjacent pump stations. Three centrifugal low-flow submersible pumps were sized to provide a total capacity of 90 million gallons per day (MGD).

Six axial flow submersible pumps with a combined capacity of 300 MGD were placed in the high flow side of the pump station to provide the remainder of the required 390 MGD flow capacity.

A Formed Suction Intake (FSI) concept was implemented for each of the axial flow pumps to enable smaller channel width, a smaller wet well and the removal of separation walls between adjacent pump tubes.

### RESULT

The innovative two-stage wet well design delivered multiple benefits to the Des Moines MWRA. A minimized wet well footprint saved them \$1.2 million in construction costs, and reduced projected operating and maintenance costs. Since its commissioning, the CSO treatment facility has successfully operated during multiple large storm events. During a severe storm on June 24, 2015, the system ran for over six hours uninterrupted pumping, treating and discharging more than 390 MGD of combined sewer flow into the Des Moines River.

D | UNDERSTANDING THE IMPORTANCE OF STORMWATER DETENTION

**This stormwater management method usually seeks to reduce the peak flow to its normal rate through the construction of basins or tanks.**

Stormwater detention is needed when high peak flows significantly increase the risk of flooding or combined sewer overflows (CSOs). This stormwater management method usually seeks to reduce the peak flow to its normal rate through the construction of basins or tanks. These basins or tanks collect stormwater and slowly release it back at controlled rates.

## D1

### **DETENTION BASINS**

Detention basins are the optimal control solution to regulate stormwater flow into the pump stations and avoid using CSOs. These large concrete tanks store stormwater temporarily and drain slowly when the system is ready to pump water to a treatment plant.

In urban areas with limited space, detention basins are often built underground. Underground construction also improves the safety, hygiene and aesthetics of wastewater systems. Once these systems are able to handle the flow, detention basins are emptied and sewage is pumped back to the wastewater system.

## D2

### **SIZE OF DETENTION BASINS**

The size and geometry of detention basins vary greatly depending on use cases, but rectangular and circular shapes are most common. Regardless of size and shape, basins are usually emptied through outlets on the side or in the center on the bottom.

A variety of methods are used to calculate the proper size of detention basins. These include the Rational Method (RM), Modified Rational Method (MRM), Full Detention or Runoff Method (FDRM) and Hydrological and Hydraulic Modelling (HHM). A qualified person must determine which method is right for your requirements and develop the necessary calculations for the design.

Sedimentation is the main challenge related to use of detention basins. It can cause foul odors and contamination and in severe cases, it can also clog pumps if the receiving station is emptied at once without the continuous suspension of solids. Continue reading this section to receive a brief description of best practices for emptying basins.



With Outlet in the Centre



With Outlet in the wall

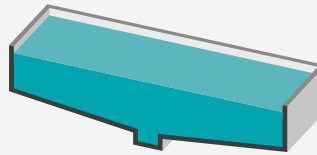

With Outlet in the Centre

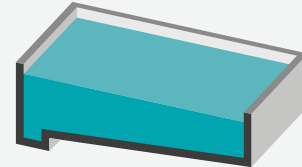

With Outlet in the wall

## Design Considerations

Consider the following aspects in the design of your detention facilities:

- | Characteristics of potential design sites
- | Grading of the tanks
- | Pump characteristics
- | Discharge outlet location and overflow structure
- | Trash screen/Trash rack requirements
- | Access requirements and operation control
- | Monitoring and maintenance instrumentation

## D3

### INFILTRATION TANKS

These underground storage tanks are commonly made of plastic modules that infiltrate collected rainwater. Their modular system makes infiltration tanks cheaper and faster to construct than concrete detention basins, but they do not have the same capacity for storing and handling large volumes of runoff in short periods of time.

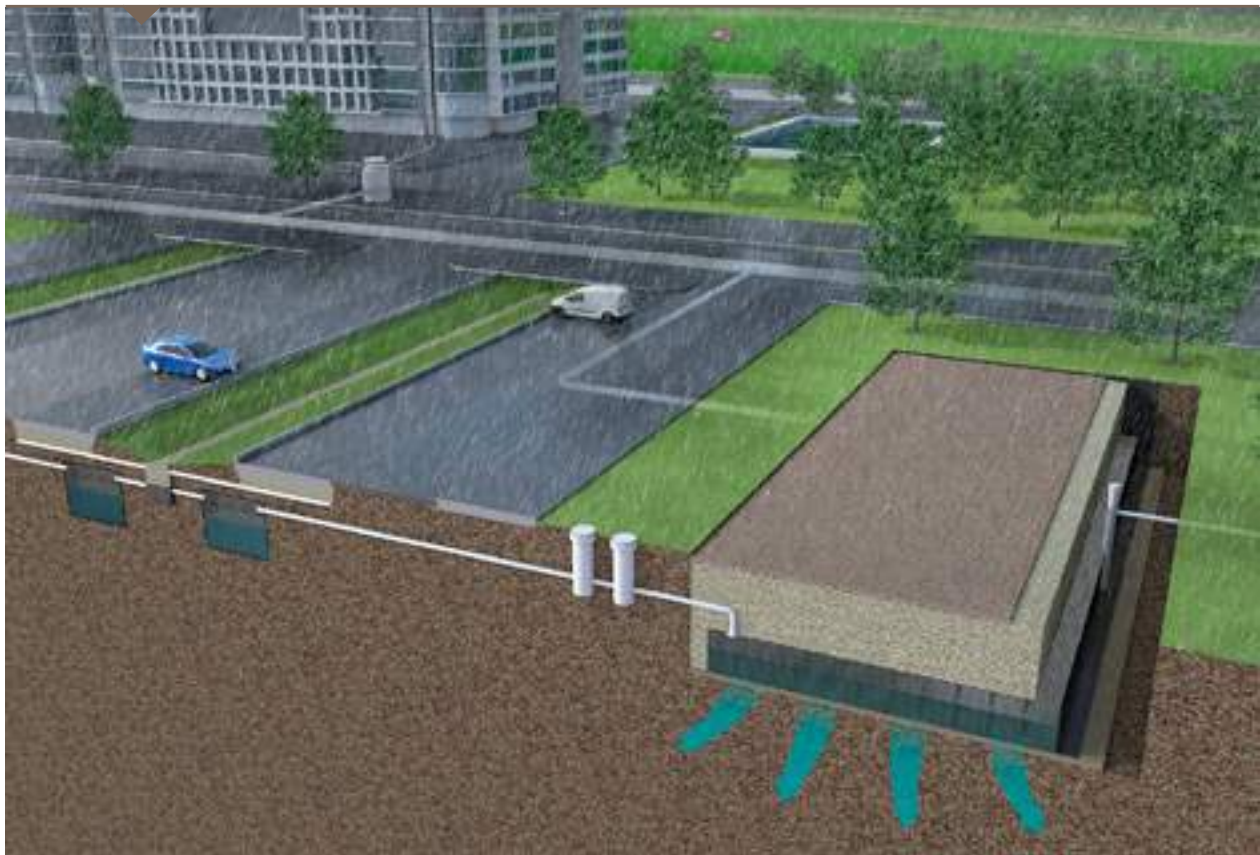

## D4

### ALTERNATIVE DETENTION SYSTEMS

In flood-prone and extremely dense cities, smart engineering solutions can improve water resilience and protect human life and key infrastructures. Traffic tunnels, which can also be used as detention basins, deep detention tunnels and deep water detention stations are prime examples of alternative solutions.

The Kuala Lumpur Smart Tunnel (SMART) is an ideal model for megacities seeking to simultaneously solve traffic and stormwater challenges. This 9.7-kilometer (6-mile) long tunnel was designed to redirect floodwater before it enters Malaysia’s capital city. It uses a holding basin with a floodwater storage capacity of 600,000 cubic meters (21,188,800 cubic feet), a reservoir with a 1.4 million-cubic meter (49,440,533 cubic feet) capacity and a bypass tunnel. After a storm, the tunnel is emptied using large pumps and municipal cleaning vehicles remove any remaining sediment.

The tunnel also features a three-kilometer (1.9-mile) “double-decker” highway. During dry periods, vehicles can use the lower highway (pictured in the diagram below) as an alternative to the city’s main thoroughfares.

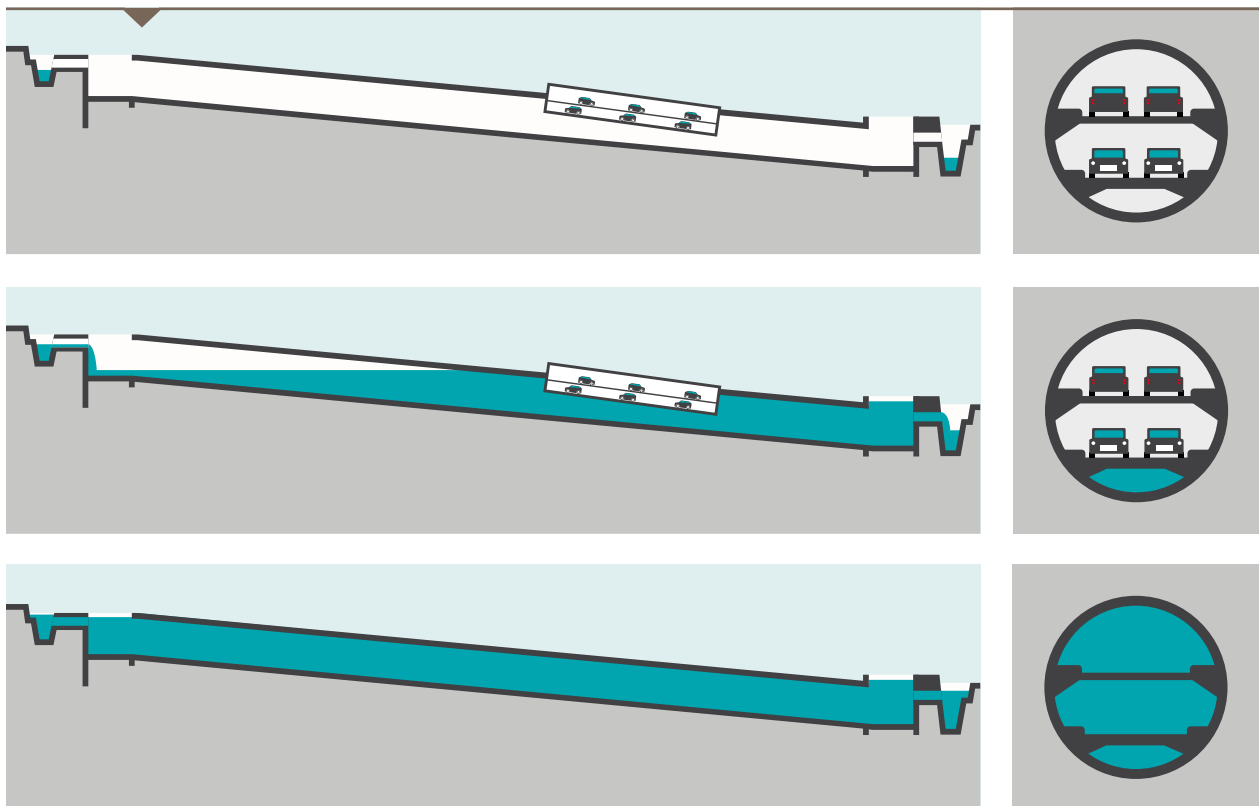



## D5

### DEEP STORMWATER DETENTION

Deep detention tunnels significantly increase the storage capacity of wastewater and mixed handling systems. These systems can be added to existing sewer systems or used to replace old solutions using Tunnel Boring Machine (TBM) technology.

During the design phase, evaluate the following risks if you are considering a deep detention tunnel as a stormwater management solution. Compared to traditional egg-shaped sewers, deep detention tunnels carry an increased risk of sedimentation-related problems—especially during extended dry periods.

In addition to sedimentation-related risks, consider which method will be used to empty the detention tunnel and how deep the tunnel will be. For these detention facilities, pumps should be designed to manage high flows and high heads, and pump motors must be protected against the risk of submergence. Stations with a depth of more than 20 m (65.6 ft) can only function with direct-coupled submersible pumps. Consider that pumps with motors installed on the ground level require significant investment and maintenance costs.

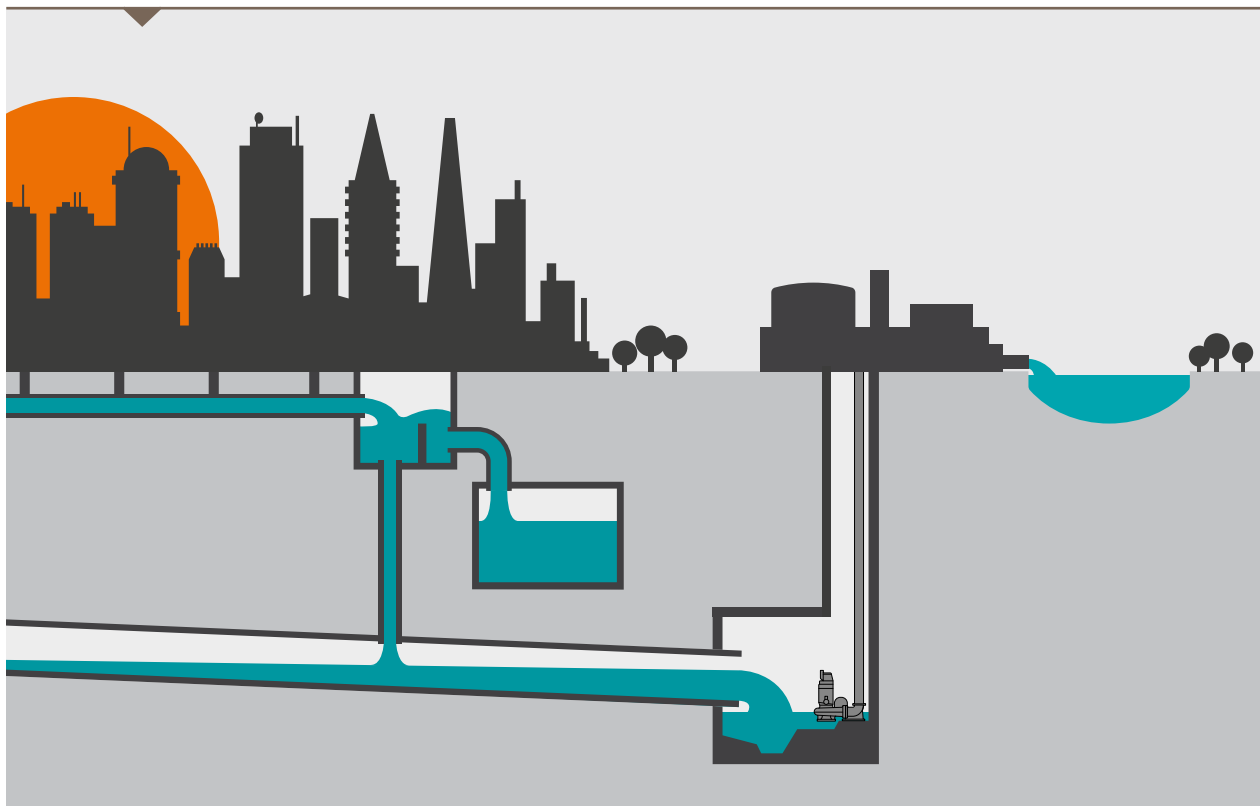

## D6

### STORMWATER DETENTION BASIN CLEANING

All stormwater detention projects must include a consistent operation and maintenance program for cleaning to address the challenge of sedimentation and ensure optimal performance.

Consider the advantages and disadvantages of some common detention basin cleaning practices:

#### Manual Cleaning

Cleaning detention tanks manually or with vacuum trucks poses unnecessary safety and health risks for service teams. Although many municipalities still employ this method, it should not be considered a viable solution.

One disadvantage of this cleaning method is the way sediments are transported. Because a high content of sediments is transported in a single flush, it can clog and damage pumps, and cause additional problems at the treatment plant.

#### Tipping Buckets

Tipping buckets are widely used to clean stormwater detention tanks. Compared with installing mixers and ejectors, this longstanding cleaning method requires relatively low investment and operating costs.

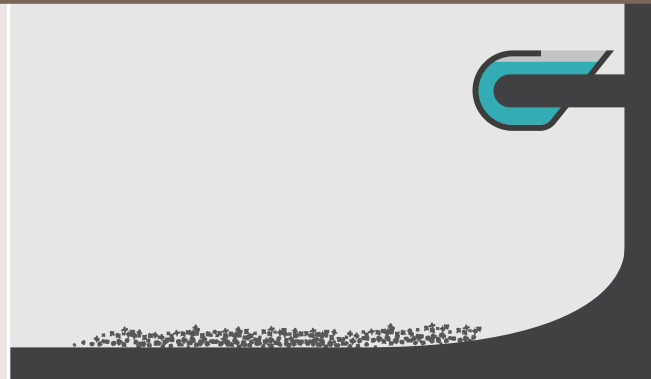

#### Advantages

- Relatively low investment cost
- Low operating cost
- No advanced control equipment required

#### Disadvantages

- Sewage with a high concentration of sediments is flushed to the pumps
- High risk of problems in the wastewater treatment plant
- High risk of pump clogging
- Inability to aerate or mix the stored sewage

## Flushing Gates and Stormwater Flushing

Flushing gate systems enable sediments from sewer pipes and rectangular detention tanks to be swept away by the next stormwater events. This is often a good solution in regions where extended dry spells are common.

Because flushing gates require fast-acting hydraulic cylinders and a special detention tank design, this cleaning method is more expensive than tipping buckets; it remains a cost-effective solution compared to other methods.

Flushing gates are mainly used to clean large channels. They rely on a similar cleaning flush technique to tipping buckets, and present similar challenges.

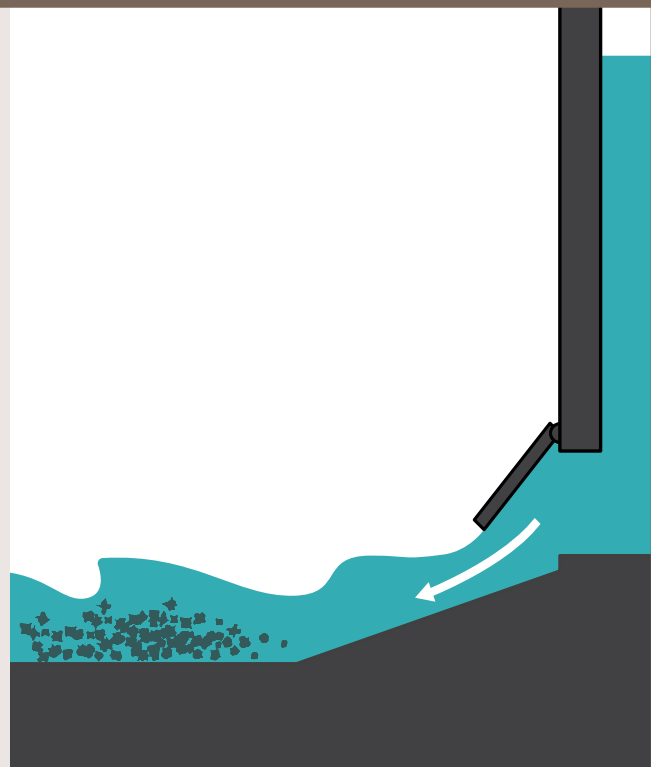

### Advantages

- Simple system for channel cleaning
- Low operating cost
- No advanced control equipment required

### Disadvantages

- Sewage with a high concentration of sediments is flushed to the pumps
- High risk of problems in the wwtp
- High risk of pump clogging
- Inability to aerate or mix the stored sewage

## Bulk Flow and Flushing

Creating a bulk flow (the rotation of liquid inside the basin) with submersible mixers, hydroejectors and air-water ejectors enables to suspend solids while the basin is emptied. These solids are then transported with the liquid out of the detention basin and back into the system.

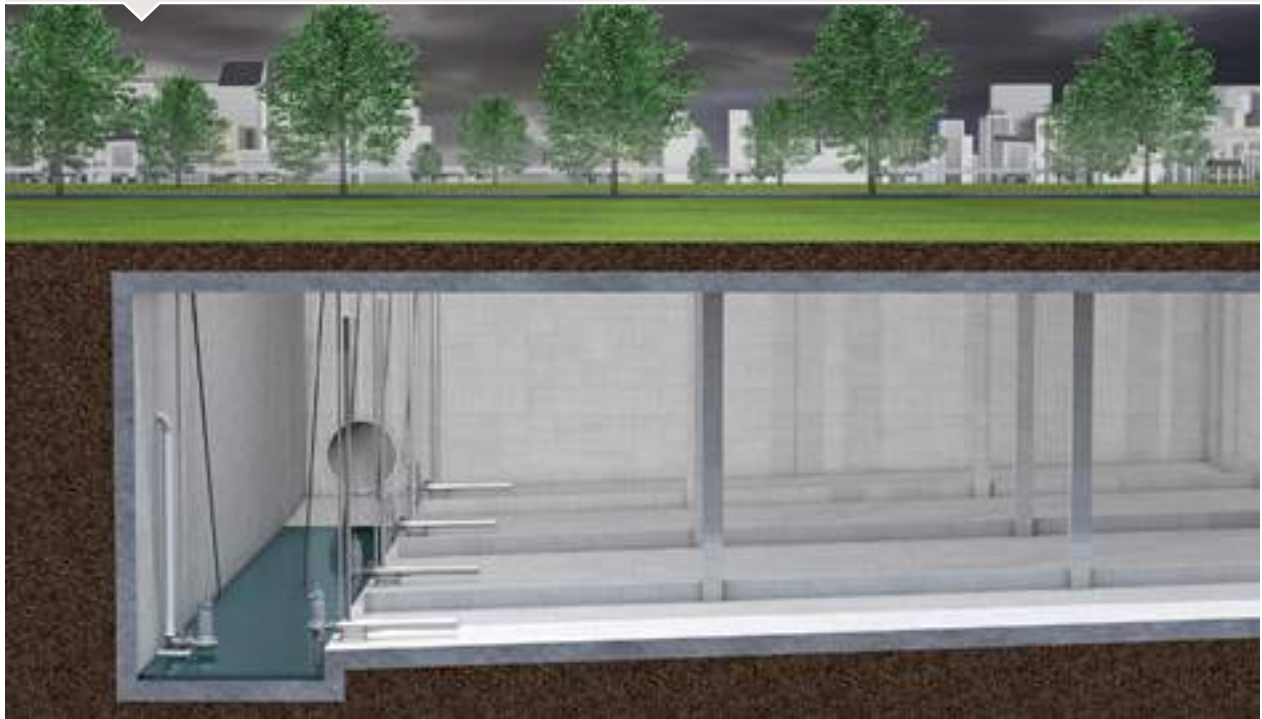

## Submersible Mixers

These mixers help avoid sedimentation in detention tanks by keeping solids suspended and creating a uniform mixture. Their propeller hydraulic design makes them ideal for large bulk flows with low power consumption.

### Advantages

- Highly efficient
- Well-mixed, uniform effluent
- Low operating cost

### Disadvantages

- Cannot operate in water levels below 0.50 m (1 ft)

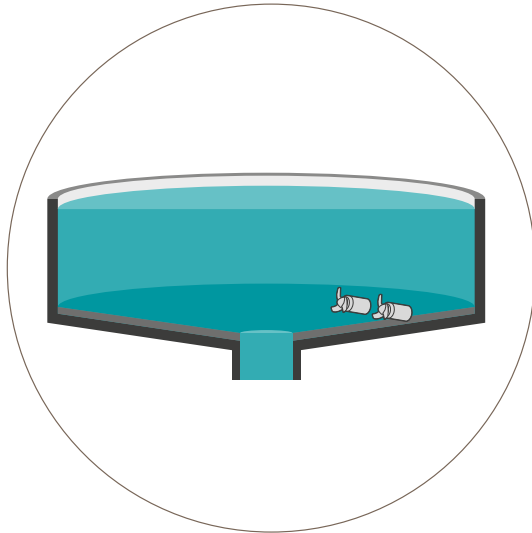

Solids settle at the bottom of the basin.

A combination of mixers and/or hydroejectors provides the bulk flow, bringing solids into suspension.

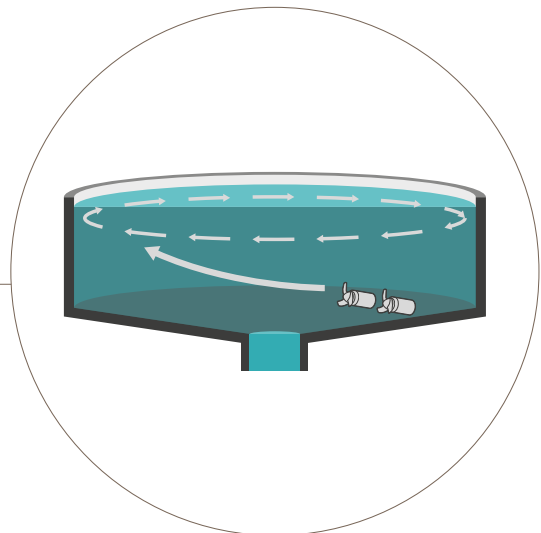

As the water is drained through a central point, so are the suspended solids...

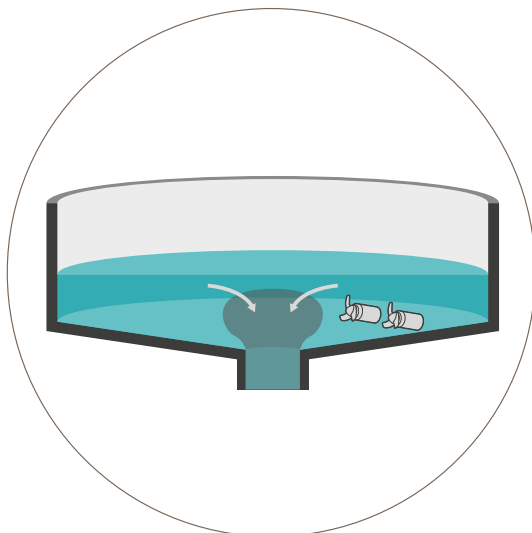

... leaving the basin clean at the end of the operation.

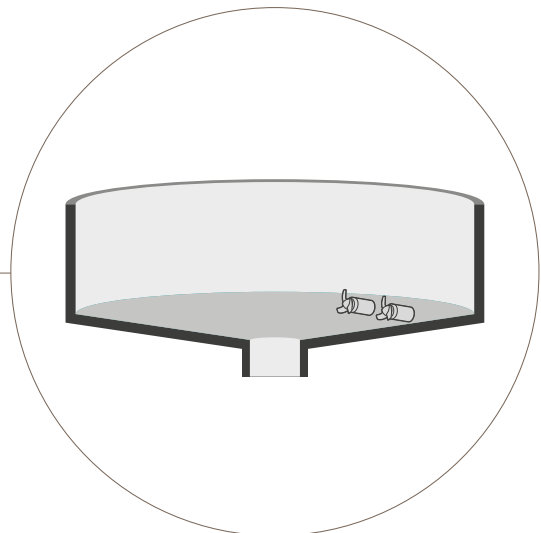

## Ejectors Families

Ejectors utilize the jet discharge from a pump to create a bulk flow and flush tanks.

Air-water ejectors combine air to the water for the mixture to reach longer distances.

## Air-Water Ejectors

These ejectors create a long, sweeping water jet to clean the surface of the detention tank during the final emptying phase.

The pump is equipped with a suction pipe and installed at the lowest point of the tank, above the outlet channel. This makes it possible to flush the bottom of the tank even when the water level is zero.

**Air-water ejectors are equipped with an air suction pipe to provide some aeration and create the "sweeping" flush.**

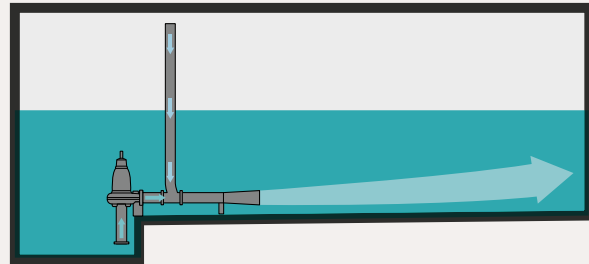

### Advantages

- Highly efficient in cleaning tank bottoms
- Can operate at 0 water level
- Creates uniform effluent

### Disadvantages

- Despite reducing can spread odor due to the entrained air.

## Hydroejectors

Hydroejectors are also designed to clean the bottom of the detention tank during the cleaning cycle. Compared to air-water ejectors, their flush is wider, but it reaches shorter.

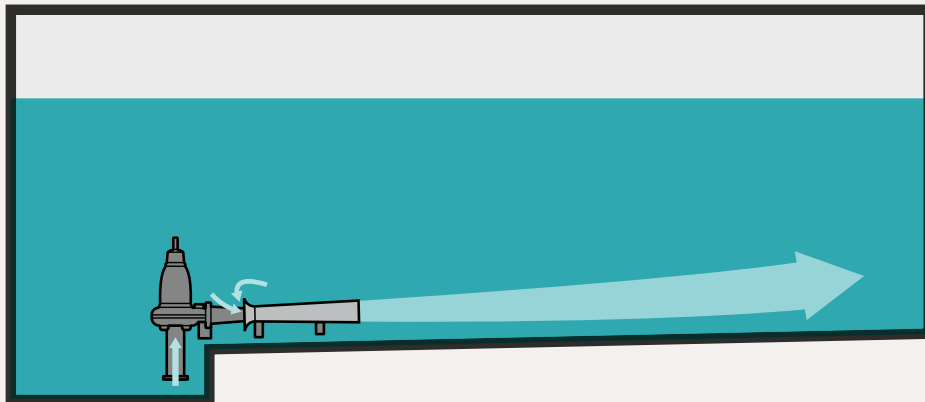

### Advantages

- Creates a wider jet than air-water ejector
- Creates uniform effluent
- Less odor due to absence of entrained air

### Disadvantages

- Shorter jet than air-water ejectors
- Cannot operate at 0 water level

### Rotating Air-Water ejectors

These ejectors function in exactly the same way as fixed, installed air-water ejectors. Because the discharge can be rotated around its stand's midpoint in any direction within a 270° sector with a stepper motor, rotating air-water ejectors can clean a larger area using just one pump. All equipment is fully submersible.

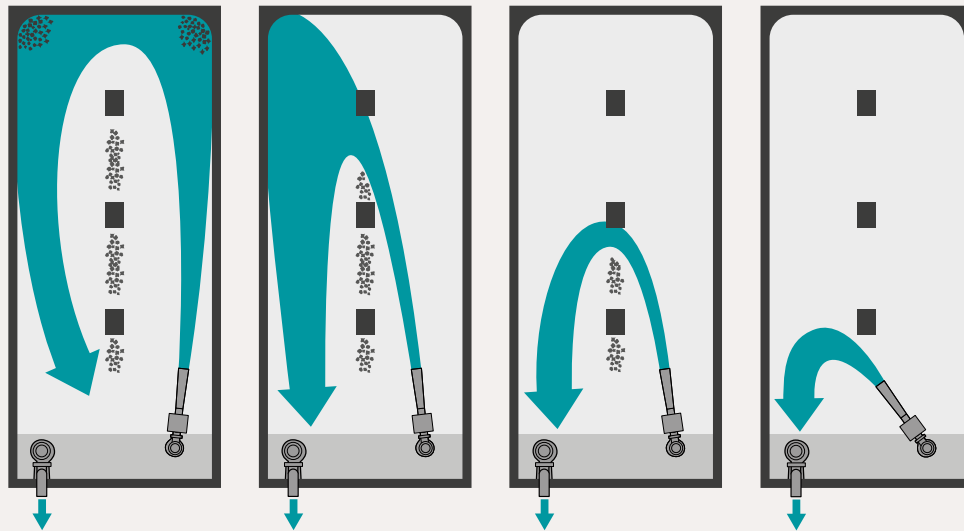

#### Advantages

- Can clean a much larger area than fixed air-water ejectors
- Can operate at 0 water level
- Creates uniform effluent
- Reduces odor due to absence of entrained air

#### Disadvantages

- Requires advanced control equipment
- Investment cost
- Despite reducing can spread odor due to the entrained air.



# D7

## XYLEM'S RECOMMENDATIONS FOR STORMWATER DETENTION BASIN CLEANING

When sufficient depth is available, we suggest creating a bulk flow in the basin or tank to properly clean stormwater detention basins. Use either mixers or ejectors to create a bulk flow and suspend particles. When the water depth decreases to a level at which the further ends of the basin are aired, use air-water ejectors at the short end to flush sediments from the bottom during the final emptying stage.

### Design Guidelines for Cleaning Detention Tanks

The most common method for operating the cleaning equipment when emptying the tank is described below. A specific setup may be needed depending on your project requirements, and Xylem offers a wide variety of design recommendations for different setups.

All cleaning units can operate continuously in liquid levels of 1.5 to 2 meters (5-7 ft). Start mixers at a slightly higher liquid level than ejectors.

The slope of the bottom of the tank impacts the reach of the jet. Increasing the slope from one percent to five percent reduces the jet reach by approximately four meters (13 ft).

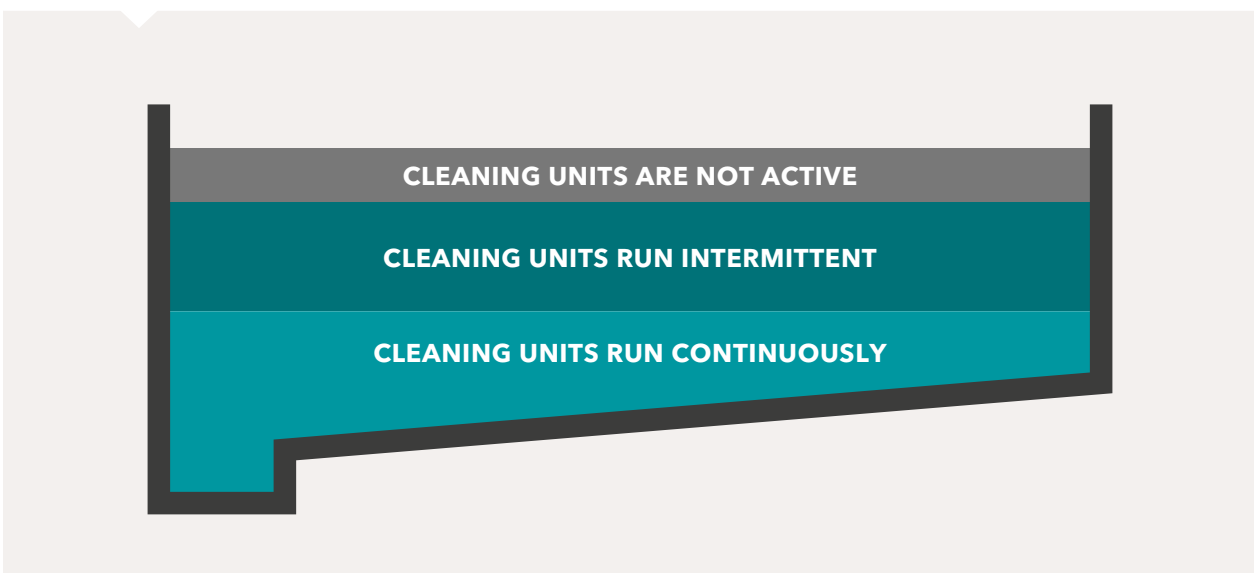

CONTACT YOUR LOCAL XYLEM OFFICE FOR MORE INFORMATION.

### Selection of Mixer and Jet Aerator

Xylem recommends the use of our small mixers for cleaning of small and circular detention tanks with high bottom slopes only where the satisfactory cleaning can be achieved with a lower life cycle cost compared to installing ejectors. The required submergence for the mixer limits the shear forces applied to the sediments for suspension and re-suspension of solids with these devices only are recommended in circumstances where the cleaning can be achieved with lower energy consumption.

Water ejectors are selected based on the required surface overflow rate (SOR) value. Although they keep sediments in suspension and create a bulk flow, similar to mixers, they are designed for mixing and not to clean detention tanks due to the submergence requirement. Water ejectors are not recommended by Xylem to be installed for detention tank cleaning. Air-water ejectors, either fixed or rotational are the recommended solution by Xylem for detention tank cleaning.

Ensure the slope of your rectangular detention tank equipped with an air-water ejector falls between 1.2% and 1.5%. Meanwhile, confirm the length of the tank does not exceed three times the width of the area being cleaned. Install two air-water ejectors side-by-side in wider stations, and use a wall measuring at least 0.5 meters in height to divide sections. Xylem can recommend a variety of equipment configurations, based on how many pieces of equipment are being used as well as the shape of your tank. Some of the most common configurations are included in the examples below. For more information and advice regarding your specific project, contact your local Xylem office.

### Mixer Selection

Design criteria for Flygt mixers installed for cleaning in circular basins.

The following points should be considered:

- | Tangential inflow into the detention basin.
- | Center drainage (sump or drain funnel).
- | Bottom slope to the central pump discharge funnel is between 3.0-12.0%.
- | Columns be positioned in or near the drainpipe, if necessary.
- | Closed middle structures should be avoided as the medium can not flow freely into the hopper or sump.

| In structures with columns or middle structures, several mixers must always be provided, even for small basins.

| Inclination angle of the mixer depending on the number of units be  $55^\circ - 65^\circ$ .

| Positioning for single and double units is given. Positioning with more than 2 mixers is carried out on a project-specific basis and would be provided by your local Xylem office.

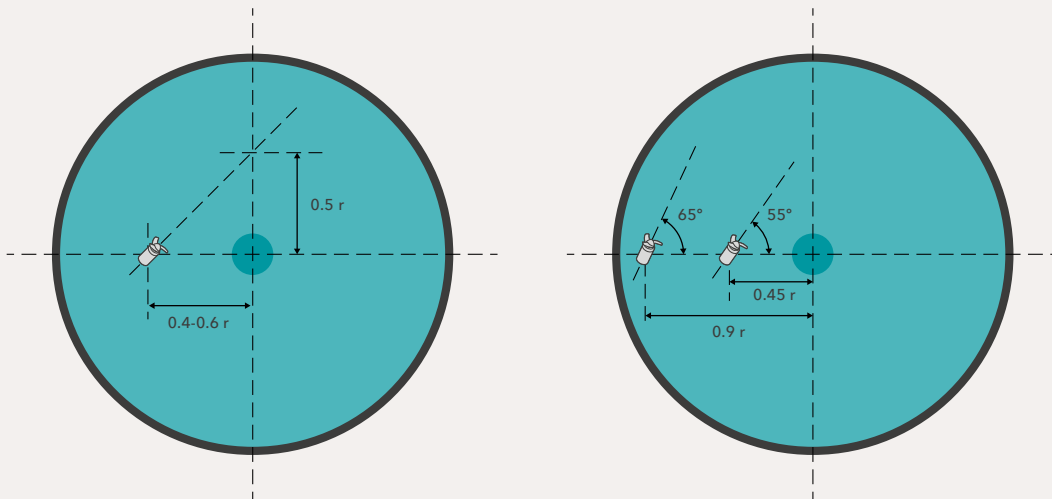

DIAMETER (MAX.)	NUMBER OF UNITS	MODEL
11,0 m	1	4620
16,0 m	2	4620
20,0 m	3	4620
23,0 m	4	4620

For larger tanks and use of other mixers family in your installation are done based on request. Please contact your local Xylem office for assistance.

### Air-Water ejectors

The reach of the ejector both in length and width are the crucial design parameters for selecting the type and the number of air-water ejectors for cleaning a detention basin which are given in the table below for our AW 100 and 150 models. These values can be easily used for the design of rectangular detention basins.

A number of ejectors may be used in long, narrow basins in which the length is several times the width. In this case, the basin is considered as being divided into zones, one for each ejector. The zones may be of different sizes (L1 usually being longer than L2), they may be sized for different ejectors. The ejector(s) closest to the trough shall always be positioned for its maximum length, for the given basin slope, before the next ejector. The jet from the ejector will otherwise disturb the inlet to the next ejector. The last zone must have a length-to-width ratio between 1 and maximum jet length.

More than two ejectors can be located in a very long, narrow basin by applying the principles described above. For these basins with multiple ejectors in series it is better to have them run with a combination of large and small pumps for the ejectors.

Similarly, a wide basin in which the trough is located beside a wall and W is several times longer than L can also be divided into sections consisting of a number of smaller rectangular basins, each of which is provided with an ejector. In this case, baffle partitions about 250 mm high shall be used to divide the basin. A single pump may be used to supply the ejectors installed in a detention tank. In that case the pipes should not be installed symmetrically when installed in long basins. The pipe sizing and losses need to be calculated separately.

For circular, large or detention tanks where unusual layouts are applied contact your local Xylem office to get case specific support on cases that does not fit into the general recommendations given on this manual. Our experts in Xylem office would be more than happy to help you with the design details for achieving a satisfactory cleaning.



Select pumps based on required power and sewage property (F or N)

**AIR-WATER EJECTOR TABLE FOR RECTANGULAR DETENTION TANKS FOR AW 100 MODEL**

MAX. LENGTH (L)	WIDTH (W)	UNITS	REQ. POWER P2
12 m (40 ft)	4 m (13 ft)	1	3,1 kW (4.2 hp)

**AIR-WATER EJECTOR TABLE FOR RECTANGULAR DETENTION TANKS FOR AW 150 MODEL**

MAX. LENGTH (L)	WIDTH (W)	UNITS	REQ. POWER P2
15 m (50 ft)	4.0 - 5.0 m (13 - 17 ft)	1	4 kW (5.4 hp)
19 m (60 ft)	5.0 - 6.5 m (17 - 22 ft)	1	5 kW (6.7 hp)
24 m (80 ft)	6.5 - 8.0 m (22 - 27 ft)	1	9 kW (12.1 hp)
30 m (100 ft)	8.0 - 10 m (27 - 33 ft)	1	13 kW (17.4 hp)
34 m (115 ft)	19 m (60 ft)	1	18 kW (24.1 hp)

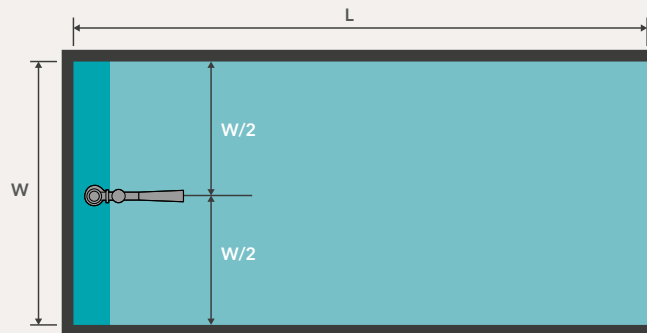

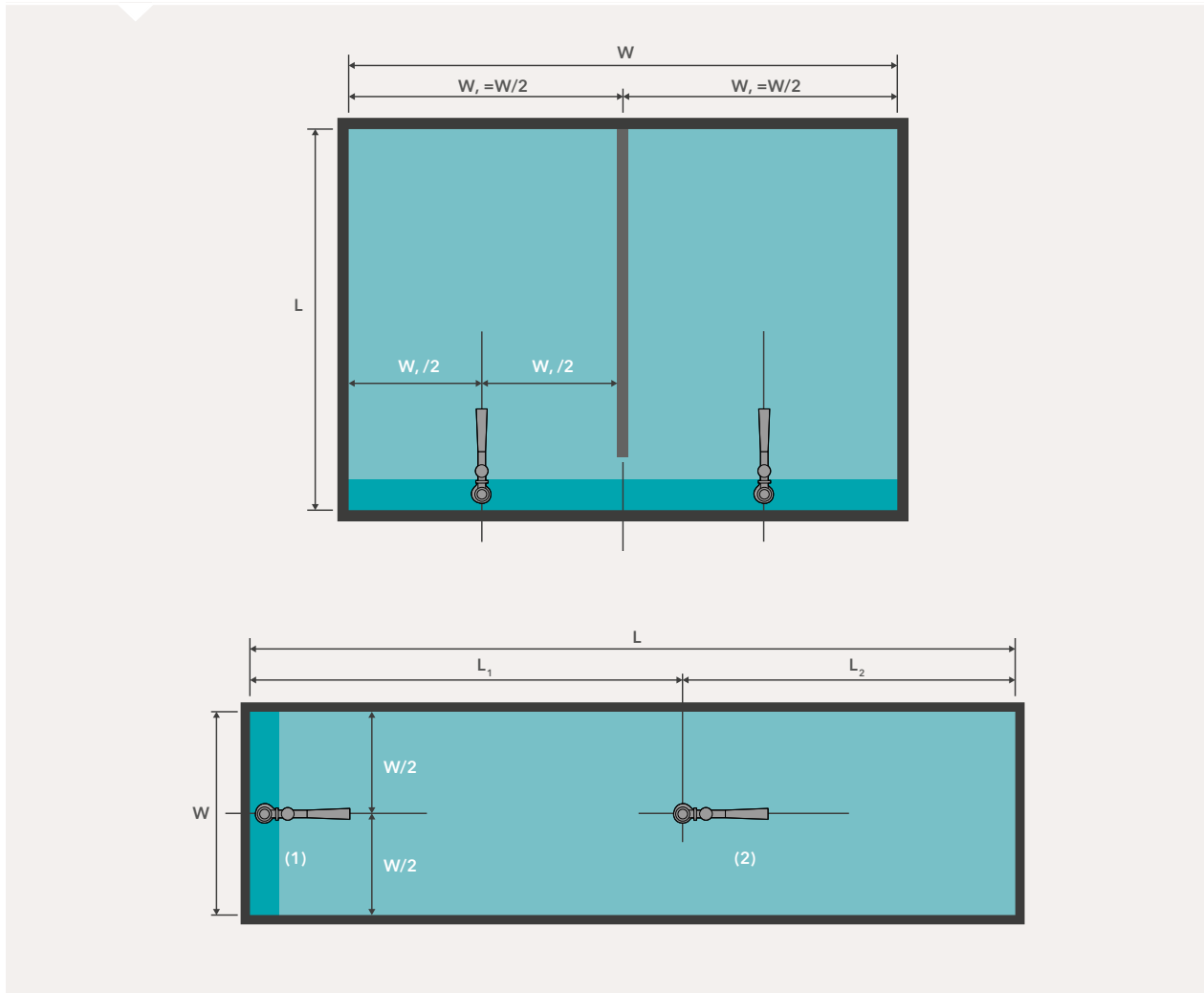

Install a rotating IUT SSR ejector in detention areas that do not fulfill the requirements for a 3/1 length/width ratio, contain circular tanks and tanks with other obstacles (i.e. pillars).

## Xylem's Products

Xylem offers rotating submersible ejectors, up to DN 200, as well as air-water ejectors, in collaboration with its German Partner IUT.

The table below provides a general guideline on the amount of space that a rotating air-water ejector is able to clean. Contact your local Xylem office for a final selection.

**AIR-WATER EJECTOR TABLE FOR RECTANGULAR DETENTION TANKS FOR IUT SSR-AW 150 MODEL**

MAX. LENGTH (L)	WIDTH (W)	UNITS	REQ. POWER P2
10 m (33 ft)	28 m (92 ft)	1	7 kW (9.4 hp)
15 m (50 ft)	35 m (115 ft)	1	11 kW (14.8 hp)
18 m (60 ft)	42 m (138 ft)	1	15 kW (20.1 hp)
20 m (65 ft)	50 m (165 ft)	1	18 kW (24.1 hp)
22 m (70 ft)	58 m (190 ft)	1	22 kW (29.5 hp)

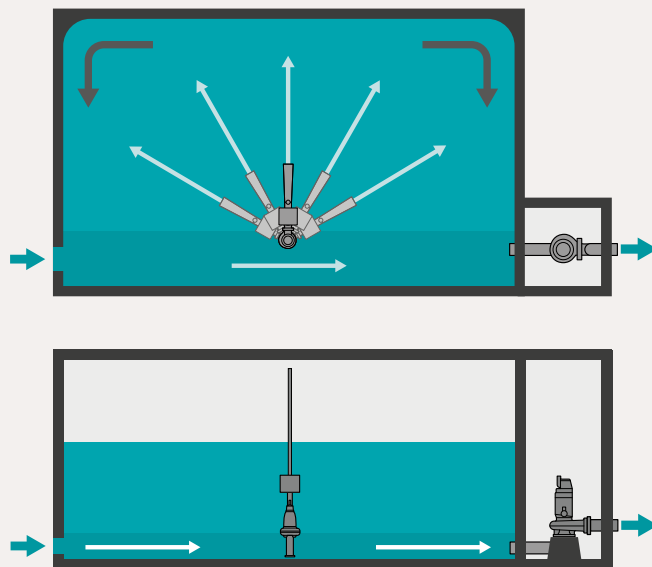

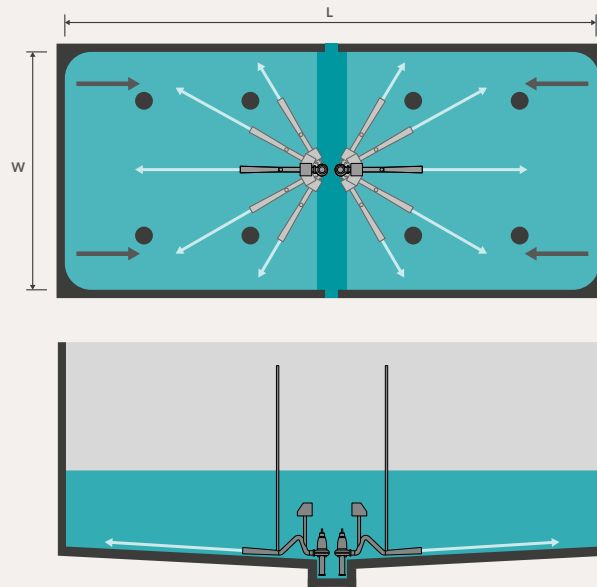

**AIR-WATER EJECTOR TABLE FOR RECTANGULAR DETENTION TANKS FOR IUT SSR-AW 150 MODEL**

MAX. LENGTH (L)	WIDTH (W)	UNITS	REQ. POWER P2
10 m (33 ft)	40 m (130 ft)	2	7 kW (9.4 hp)
15 m (50 ft)	50 m (165 ft)	2	11 kW (14.8 hp)
18 m (60 ft)	60 m (200 ft)	2	15 kW (20.1 hp)
20 m (65 ft)	70 m (230 ft)	2	18 kW (24.1 hp)
22 m (72 ft)	80 m (260 ft)	2	22 kW (29.5 hp)



Select pumps based on required power and sewage property (F or N)



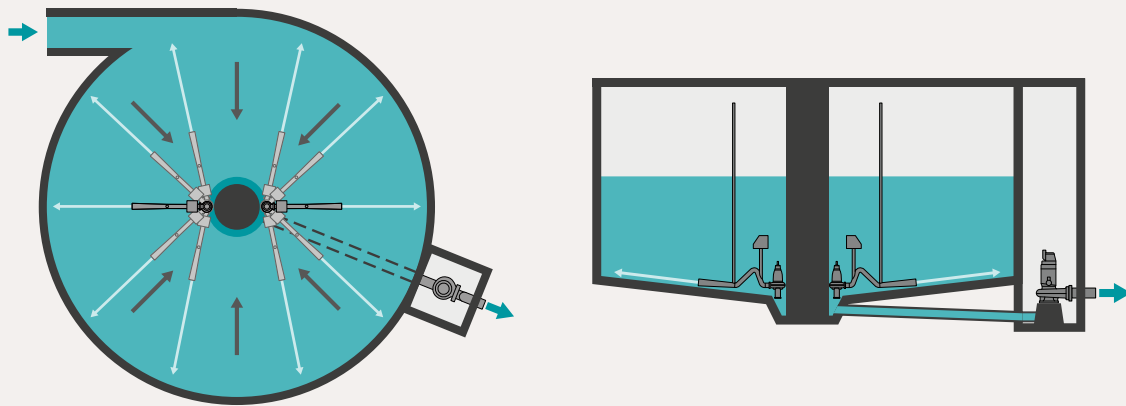

AIR-WATER EJECTOR TABLE FOR CIRCULAR DETENTION TANKS FOR IUT SSR-AW 150 MODEL

DIAMETER IN M/F	UNITS	REQ. POWER P2
20 m (65 ft)	2	7 kW (9.4 hp)
26 m (85ft)	2	11 kW (14.8 hp)
30 m (100 ft)	2	15 kW (20.1 hp)
36 m (120 ft)	2	18 kW (24.1 hp)
45 m (150 ft)	2	22 kW (29.5 hp)



Select pumps based on required power and sewage property (F or N)

Belgium treats wastewater for a part of the Walloon Brabant region that is home to more than 100,000 residents.

## FAST FACTS

<b>LOCATION</b>	Rosières, Walloon Brabant region, Belgium
<b>CHALLENGE</b>	Improving stormwater sludge management by optimizing retention basins
<b>SOLUTION</b>	Installing Flygt air-water ejectors and rescaling the structural designs of two retention basins
<b>RESULT</b>	More effective stormwater sludge treatment, and more efficient cleaning and maintenance methods



## CASE STUDY: Solving Stormwater Sludge Treatment with Design Expertise and Reliable Technology

The sewage treatment plant in Rosières, Belgium treats wastewater for a part of the Walloon Brabant region that is home to more than 100,000 residents. With a treatment capacity of 670 m<sup>3</sup>/hour (2,950 GPM) in dry weather and up to 4,680 m<sup>3</sup>/h (20,605 GPM) in stormy weather, it is the second biggest sewage treatment plant in the region.

### CHALLENGE

Commissioned in 1984, the plant underwent large updating efforts between 2007 and 2011 to ensure its installations conformed to the latest European standards. Despite the renovations, the problematic management of two retention basins continued to cause plant malfunctions and challenges related to stormwater treatment.

The Rosières sewage treatment plant contains two retention basins for stormwater sludge. During major rain episodes and other scenarios in which the acceptable maximum flow in the plant's sludge treatment is reached, the surplus of stormwater sludge is put on standby in the two basins. The surplus automatically empties and integrates into the traditional plant treatment infrastructure once a normal flow level is restored. Drainage of these basins occurs only when the management of sludge dehydration allows it.

During the years following the renovations, the Intercommunale of Walloon Brabant (IBW), which is in charge of plant operations, identified two major issues with the retention basins:

| **A Lack of Homogenization** - Sludge in the Walloon Brabant region is particularly rich in sand. When volumes fill, there is an inevitable thickening of the sludge. The concentration of sludge made up of suspended matter can vary drastically throughout a single basin and can reach up to 80 grams/liter (0.67 lb/gal). Proper (re)-suspension and homogenization of sludge is essential to ensure the proper execution of the sludge treatment steps - but it presents a real challenge.

- | **A Long and Laborious Cleaning Process** - Once drained, the two retention basins must be cleaned. Because they are not drained regularly, a significant amount of sedimentation can build up and form a layer that is difficult to remove. As a result, IBW was forced to rely on expensive draining and cleaning processes involving the use of tankers.

### SOLUTION

IBW appealed to Xylem services at the end of 2015 for assistance in improving stormwater treatment. For Frédéric Ghem, Manager of the Operation Zone at IBW, collaborating with Xylem was an obvious choice: "I have always been accustomed to working with Xylem on very sensitive cases. For me, the added value of Xylem is their ability to find solutions to difficult situations. These last years, the challenge was met and overcome each time."

In cooperation with Ghem and a team of civil engineers, Xylem was able to implement solutions to both issues mentioned above. Nathalie Derscheid, Product Manager Treatment at Xylem explains: "We made two changes: On the one hand, we have replaced the hydroejectors to ensure proper mixing in the basin. On the other hand, we re-examined the design of the basins to allow for a more effective cleaning of volumes when they are emptied."

These two operational changes enable more effective treatment of stormwater sludge:

- | **Replacing Failing Hydroejectors in Each Basin** - The former hydroejectors were clogging, did not create a sufficient mixing and presented significant wear, which resulted in many mechanical breakdowns. The new air-water ejectors were installed where significant mixing and reach were created with the two phase flow. Issues with submergence requirements were resolved so the basins can now be operated to the emptying volumes and basins be flushed. Additionally the units are equipped with Hard-Chrome impellers pumps and volutes that are resistant to very abrasive fine sands.

**Re-Dimensioning the Profiles of each Basin** - The design of both basins was reviewed to determine optimal cleaning of volume. Xylem integrated a drain pit at the edge of the basin corresponding to the needed volume of water to fulfill the last cleaning phase, which allows for maximum recovery of sludge and complete draining of the basins. Based on the hydraulic calculation, Xylem also advised on the dimensions and positioning of this drain pit to allow the different phases of hydro-ejector operation: mixing, draining and cleaning. Finally, a slope of 1% was added to the bottom of each basin in order to facilitate these various phases.

## RESULT

Xylem contributed to the complete mixing of the basins and more effective cleaning methods. The Xylem equipment installed in Spring 2017 enables the Rosières plant to operate a modern and appropriate stormwater sludge management system.

*"A very large improvement has already been seen, even if it will take a little more time to get the first exact figures."*

Frédéric Ghem

*"Our customers trust us to find reliable and optimized solutions."*

*"This is our mission within Xylem."*

Olivier Andre

E | CONTROLLING FLOODS IN RIVERS AND CHANNELS

**A large number of dense urban areas are situated on or near bodies of water across the globe.**



A large number of dense urban areas are situated on or near bodies of water across the globe. These areas need reliable pumping systems capable of handling large volumes of water to minimize the risk of flooding—and to protect residents and infrastructures. Cities located in flatland areas, where natural water runoff is slow and cumbersome, must implement a reliable flood control solution.

Flood control stations are usually built on shore, either behind or as part of a dike. When possible, these stations can also be built as a pump gate. Lifting heads for flood control stations are not particularly high (ranging from one to five meters), but they must be capable of handling massive flows. Install horizontal or vertical axial flow pumps to ensure your station is properly equipped to do so.

Demands are tough for pumps and pump stations because floodwater often contains solids, large amounts of fibrous materials and sediments. Ensure your station is designed to keep branches, leaves, weeds, trash, dirt, sand, silt, mud and soil from clogging pumps and pump sumps.

Combine the right pumps with a sound station design to enable secure operation during both dry seasons and flood events.

### Sinking Cities

Coastal cities around the world face the threat of rising sea levels. Driven by climate change, rising sea levels significantly increase the risk of disasters and pose a serious threat to large metropolitan centers like New York. Many other major cities, such as Tokyo, Shanghai, Venice, Jakarta, Ho Chi Minh City, Bangkok, New Orleans, Alexandria, Mexico City and Sydney are also sinking at an even faster rate than sea levels are rising.

As land continues to subside, the risk of coastal flooding, high tides and storm surges in these areas rises rapidly. As many of these cities expand, the overexploitation of groundwater resources for domestic and industrial use also contributes to sinking.

Some of the more established major coastal cities have already implemented functioning solutions to protect their massive amounts of infrastructure and growing populations from flooding and other water-related events. Many cities have invested in flood prevention infrastructure, policies and initiatives to restrict the extraction of groundwater and reduce the rate of subsidence. Groundwater feeding pump stations are among the most effective measures these cities are currently deploying.

### E1

#### FLOOD CONTROL PUMP STATIONS

Cities located near rivers and seashores require extra protective measures, such as dikes, locks and flood gates. During heavy rainfall and high tides, flood gates close and flood control pump stations with a very high pump capacity lift the water over closed barriers and into open bodies of water. If the calculated flow per pump is more than 7,000 l/s (111,000 gpm), only large customized axial flow pumps with fan-cooled motors can provide the necessary capacity to keep those stations running.

Installing pumps with fan-cooled motors (TEFC) in all flood control pump stations used to be common practice. But as climate change continues to cause extreme and unexpected flooding, pumps with submersible motors are increasingly recommended. If these pumps are not available, we advise station designers to consider dividing the capacity between several pumps.

#### Fish-Friendly Control Lifting Stations

In 2013, the European Union passed legislation requiring member states to identify and define solutions that protect the natural habitats of European fish species – specifically the eel. Similar regulations have also been established in North America.

Although hydro-turbines pose the biggest threat to eels, the EU legislation also impacts flood control pumps installed in stations located in rivers or channels with eel populations.

Building bypass systems and installing special screens to ensure station comply with these regulations when pumps with channel impeller are used. Slow-running screw impeller pump is another good alternative to use if site conditions allow.

Xylem has developed several systems to help customers identify the best solution for their unique case. We also offer fish-friendly pumps in collaboration with our partner for projects that present a potential risk to fish and their habitats.



CONTACT YOUR LOCAL XYLEM OFFICE FOR MORE INFORMATION.



INSTALLATION EXAMPLES

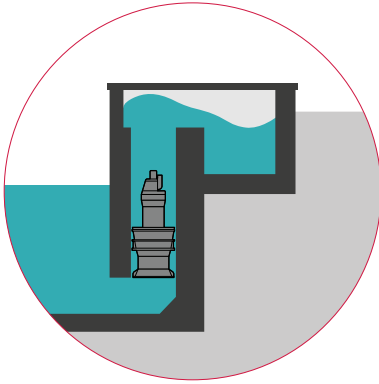

IN CONCRETE STRUCTURE  
For pumping to channel. No check valve is required.

IN MANUFACTURED COLUMN  
For pumping to channel. No check valve is required.

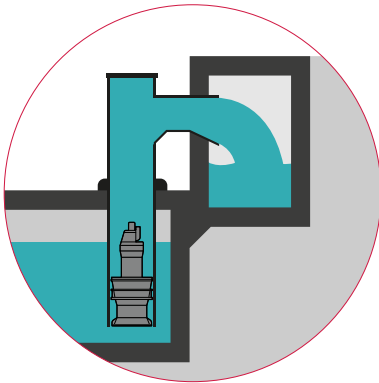
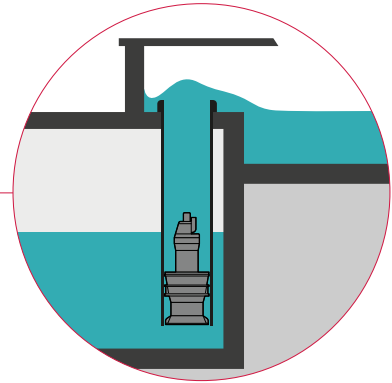

With a discharge pipe and free outlet.

With submerged outlet and flap valve.

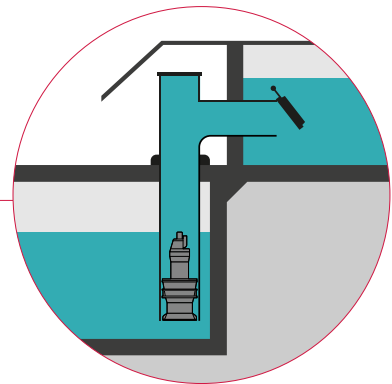

With a siphon.

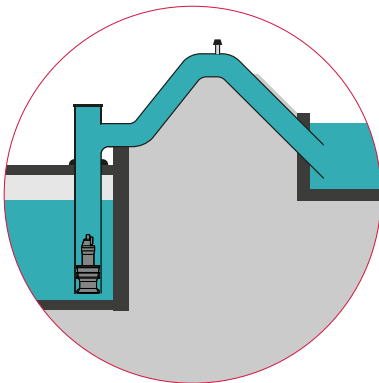

### E2

#### PUMP GATE SYSTEM

A pump gate is a flood gate equipped with pumps. This compact flood control pumping system combines flood gates and axial flow pumps to easily relieve flood pressure and allow existing waterways to operate properly.

Installing a submersible pump directly into the flood gate enables the components of a pumping station and a gated reservoir to be effectively combined. The flood gate opens to discharge retained water using the flow of gravity through the screens. The pump gate can be closed if the water level outside the flood gate rises to the trigger level. At this level, the pump forcibly discharges retained water to the opposite side of the gate to maintain the prescribed levels. Because pump size is limited by the size of the gate, flows and heads will be smaller compared to onshore stations.

Adapt pump gate systems to cut down on the costly, time-consuming legal delays and community disruptions associated with land acquisition.



## E3

### XYLEM'S OFFER FOR FLOOD CONTROL IN RIVERS AND CHANNELS

We provide specific services to help consultants design flood control pump stations and related facilities. Our offer includes a vast range of standardized pump station designs for flood control that have been developed and optimized using extensive numerical and physical testing. Combine this rigorous testing with our pump application expertise and industry experience.

#### The Result is Flood Control Pump Stations with the Following Features:

- | Smallest possible footprint at the lowest possible cost
- | Reliable handling of varying inflow levels
- | High-quality inflow to each pump under normal and extreme operating conditions
- | Easy installation, maintenance and repair

These verified stations can be designed using SECAD, Xylem's engineering software.

#### Customizing Pumps and Pump Stations for Flood Control

Some site conditions prevent the use of standard pump station designs. In these cases, we can help design customized pumps and pump stations that meet specific project requirements. Our vast engineering expertise and experience, combined with Flygt pumps and accessories, ensure our ability to deliver reliable and case-specific solutions for every project. Xylem designs, creates and arranges our solutions to ensure varying inflow conditions can be handled efficiently and effectively.

We use Computational Fluid Dynamics (CFD) and laboratory physical scale model tests to verify our designs and test every solution we offer.

FLYGT A-C SERIES

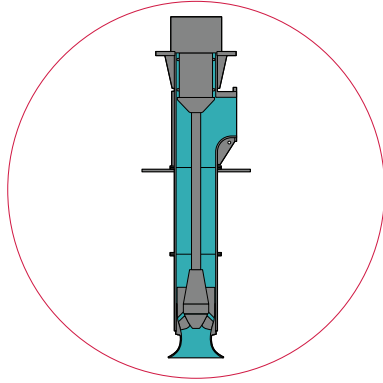

Flygt A-C Vertical Column Pump.

Horizontal Axial Flow Pumps for Cost-Effective Flood Control.

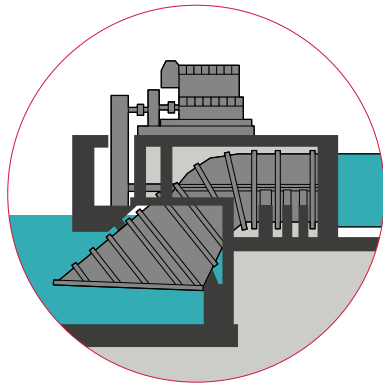
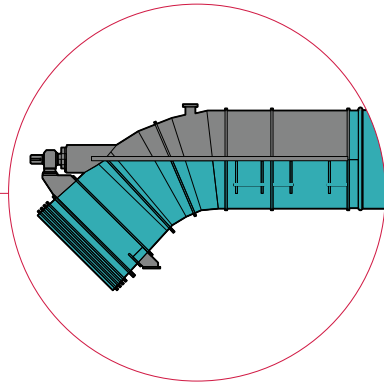

Highest Pumping Efficiency for Exceptionally Large Flows at Low Heads.

These Pumps Feature an Axial Flow Split Case Design with Decades of Proven Performance in Tough Environments.

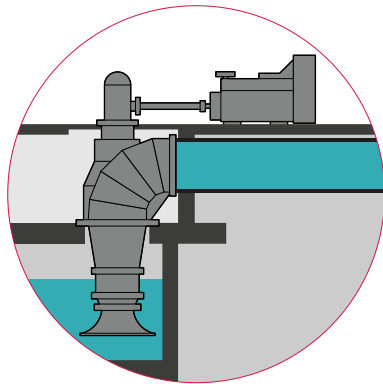
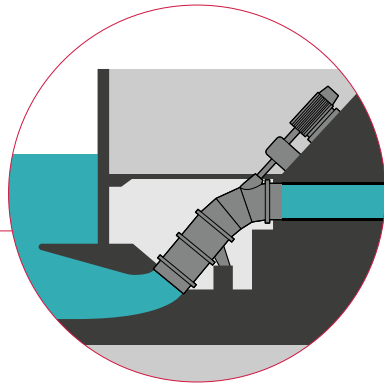

Unique Design Delivers a Variety of Operating Benefits.

Flygt submersible axial (PL) and mixed flow (LL) pumps are capable of handling a wide range of high flow variations, making them ideal options for flood control projects.

The Flygt A-C vertical column pump Series and WCXH line of axial flow pumps can be customized to meet the specific capacities and requirements of individual projects.

These pumps range in size from 0.6 to 3.7+ m (24 to 144+ in) in diameter, and they can be tailor-fitted to meet the specific needs of any application.

Customized Flygt AC pump range models enable Xylem to offer high flow capacity and provide references for pumps up to 35,000 l/s (555,000 gpm). Our horizontal propeller pumps PP 4600, PK 7000 and PP 7900 are available and customizable for pump gate projects.



No place in Europe is under greater threat from rising water levels than the Netherlands.

## FAST FACTS

<b>LOCATION</b>	Amsterdam-Rhine Canal, The Netherlands
<b>APPLICATION</b>	Flood management system for the Marijkesluis gate
<b>CHALLENGE</b>	Quickly install a new submersible pump to prevent flooding
<b>PRODUCT</b>	FLYGT PL 7125 propeller pump
<b>PUMP CAPACITY</b>	6,000 l/s (95,100 GPM)
<b>HEAD</b>	3.5 MWC
<b>RESULT</b>	A reliable, efficient and cost-effective pumping solution installed in 14 weeks, which has continued to operate successfully since 2014



## E4

### CASE STUDY: Preventing floods on Amsterdam-Rhine Canal

Xylem delivered Flygt propeller pumps in record time and enabled cost-effective, reliable flood prevention on the Amsterdam-Rhine Canal.

#### CHALLENGE

No place in Europe is under greater threat from rising water levels than The Netherlands. The Amsterdam-Rhine Canal, a vital artery that connects the port city of Amsterdam to the Rhine River, has an open connection to the sea and is highly susceptible to rising water levels during storms, winds and surge tides. A built-in sluice pump located at the Marijkesluis gate on the canal plays a pivotal role in controlling water flow in and out of the canal. When the pump needed to be replaced, Rijkswaterstaat - part of the Dutch Ministry of Infrastructure and the Environment - required a reliable and efficient replica of the existing pump to keep operations running smoothly and protect the surrounding area from flooding.

#### SOLUTION

Marcel van Halderen, Spie Nederland B.V., engaged Xylem to provide technical support in evaluating the canal's pumping needs.

"When water levels on the Amsterdam-Rhine Canal rise four meters above normal levels, the gates along the canal are closed," explains Jan Esser, Account Manager of Special Products. "Built-in pumps play a crucial role in dewatering the canal on the low side to avoid flooding the surrounding low-lying land."

The Xylem team recommended a submersible propeller pump with a 345kW (670 hp) motor - as the ideal solution for cost-effectively transporting large volumes of water at low heads. These compact Flygt propeller pumps feature N-Technology for continuous, clog-free pumping. This ensures unrivalled reliability and efficiency during operation. The Flygt PL pump supplied for this project is capable of delivering approximately 6,000 l/s (95,100 gpm).

#### RESULT

A quick-installation replacement pump designed for long-term reliability and efficiency was delivered in record time. Installation was completed in just 14 weeks; significantly faster than the 42 weeks it would have taken to implement the solutions proposed by other pump providers. The Flygt propeller pump has operated successfully since its installation in April 2014 and continues to ensure that life flows smoothly along the Amsterdam-Rhine Canal.

F | PROVIDING FLOOD RELIEF IN URBAN ENVIRONMENTS

**Flood relief is defined as a quick response to a major storm event using flood control equipment.**



Flood relief is defined as a quick response to a major storm event using flood control equipment, such as portable dewatering pumps and piping systems, to dewater flooded areas during and after a crisis. This requires 24/7 support personnel to assemble the pumping system and provide drainage assistance.

# F1

## EMERGENCY BYPASS CONTINGENCY PLANNING

Planning is key to effective flood relief. A robust contingency plan significantly reduces both response times and costs associated with environmental and property damage.

Work with an experienced dewatering partner to develop a contingency plan that includes:

- Analysis**
  - | Customer operations
  - | Identifying potential issue areas in a flood-prone network
  - | Technologies and equipment required to tackle flooding when it occurs
- List of Mitigating Actions**
  - | Pump deployment
  - | Measures required to mitigate damage
- Contact and Logistic Information**
  - | List of emergency response equipment needed in the event of a flood
  - | 24/7 emergency contact information for qualified and responsive experts
  - | Directions to emergency bypass locations

Create and circulate copies to key stakeholders who are in charge of quickly activating that contingency plan.

Complete contingency plans should provide access to independently powered backup pumps. They can also act as a preventative tool by including provisions about rental equipment that can be deployed for non-emergency applications, such as repairs and regular system maintenance. Proactive maintenance helps prevent sanitary sewer overflows and other issues that can cause damage.

## F2

### **XYLEM RENTAL FLEET**

Flood-prone municipalities are increasingly relying on rental dewatering companies as a cost-effective and reliable option for sourcing pumps and other equipment for both emergency response and planned projects.

Make sure pump rentals are included as part of your emergency response contingency plan. Consider the multitude of scenarios in which pumps may be needed, such as mechanical failures to power outages. Wherever and whenever pumps are needed, Xylem is available to offer its customers a quick fix.

As the only global company operating in the dewatering application that manufactures, rents, sells and services its own equipment, we can provide our customers with access to a broad range of market-leading, reliable dewatering technologies and solutions.

Xylem owns the world's largest rental fleet of 20,000 assets, including:

- | A line of submersible pumps ranging from compact, portable units for small drainage jobs, to larger dewatering pumps for emergency response situations.
- | Fully automatic diesel, electrical or natural gas-powered solids-handling, dry-priming pumps for high-volume, high-discharge heads.
- | A full range of hydraulic submersible pumps for general duty in dewatering, bypass, drainage and sludge applications.

We also offer remote monitoring technologies, including [Godwin Field Smart Technology \(FST\)](#), which provides crucial pump operating data for pumps situated in remote locations.

This technology significantly reduces - in some cases eliminates - the need for onsite personnel to monitor pumps manually. This frees these individuals to focus on other mission-critical operations. Customers can remotely monitor and control the operation of a pump located anywhere in the world, and gain real-time insights into critical performance parameters that provide peace of mind.

The following case study serves as a powerful example of how effective planning can mitigate the damage of severe weather events. We cannot prevent disaster events from occurring, but we can ensure that we are properly equipped to respond when they do.





North and South Carolina experience record-shattering rains and flooding in the aftermath of Hurricane Joaquin, known as the “thousand-year storm.”

FAST FACTS

<b>LOCATION</b>	North and South Carolina
<b>APPLICATION</b>	Rental dewatering pumps for emergency flood relief
<b>CHALLENGE</b>	Mitigating the impact of record-shattering rains and flooding
<b>NUMBER OF PUMPS</b>	Hundreds of pumps were deployed to handle different capacities and head
<b>RESULT</b>	Effective contingency planning aided timely delivery of reliable rental dewatering equipment and ensured continuous access to water supply for Carolina residents

## CASE STUDY: Providing Timely Flood Relief to the Carolinas

Xylem's rapid-response rental dewatering solution kept water flowing for residents of North and South Carolina during "thousand-year storm."

### CHALLENGE

In October 2015, North and South Carolina experienced record-shattering rains and flooding in the aftermath of Hurricane Joaquin. Known as the "thousand-year storm," the dramatic weather event caused a dam in Columbia, South Carolina to break and canal water levels to plummet eight feet.

As a result, the city's main water treatment plant was no longer able to draw water from the canal. The city required a rapid and dynamic emergency pumping response to replenish the holding reservoir.

### SOLUTION

Every moment counts when it comes to effectively mitigating the impact of severe weather events and building a community's resilience. Xylem anticipated the need to remove floodwaters from communities and businesses impacted by Hurricane Joaquin, and proactively began preparations. We strategically leveraged our network of rental hubs across the United States to transport hundreds of Godwin high-performance dewatering pumps and accessories to locations under pressure from the storm.

With these pumps already in place, Xylem was able to deliver relief to key sites within a matter of hours. Xylem engineers installed diesel pumps to transport water from the canal to Columbia's holding reservoir. Godwin pumps were delivered to the site and began pumping on the same day the Xylem team received the call.

### RESULT

Effective contingency planning helped to ensure that communities in North and South Carolina could access the dewatering equipment they needed, when they needed it, to minimize emergency response time and accelerate recovery. But even with precision planning, severe weather events remain unpredictable. When the dam in Columbia proved unstable, the Army Corps was forced to shut off all water to the canal. Within 24 hours, Xylem was able to transport and deploy additional pumps and pipeline from the state of New York to replenish the reservoir directly from the Congaree River. This rapid response kept water flowing to residents and avoided a mass evacuation of the city's hospitals.

G | MONITORING AND CONTROL IN STORMWATER MANAGEMENT FOR URBAN ENVIRONMENTS

Accurate overview of performance and enables customers to see what is happening at their pumping stations.

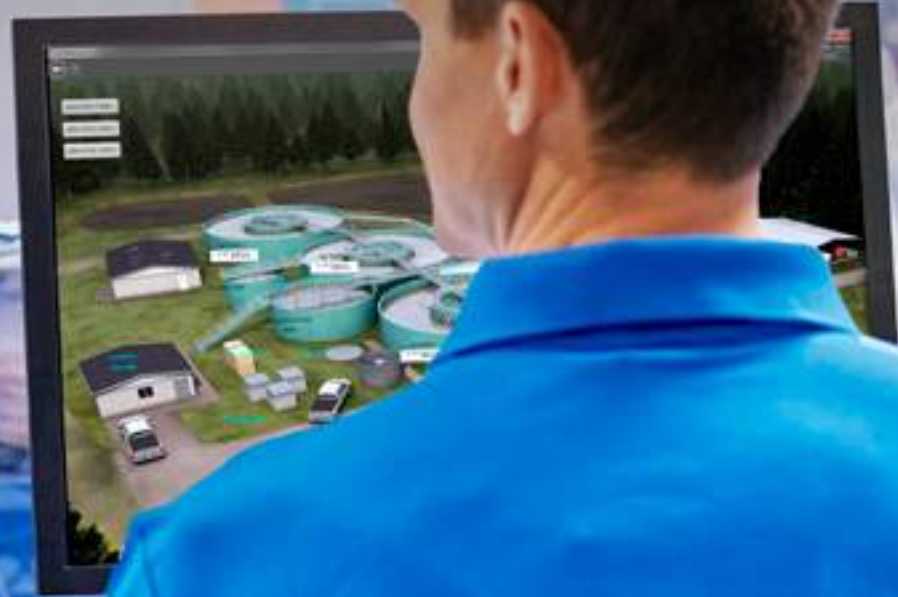

Monitor and control (M&C) is the process of measuring performance and taking corrective action to ensure that a pumping system is achieving its short-term and long-term objectives. M&C is crucial because it provides an accurate overview of performance and enables customers to see what is happening at their pumping stations. It empowers them to prevent incidents and make the right decisions.

The role of M&C in urban stormwater management consists of three levels of control:

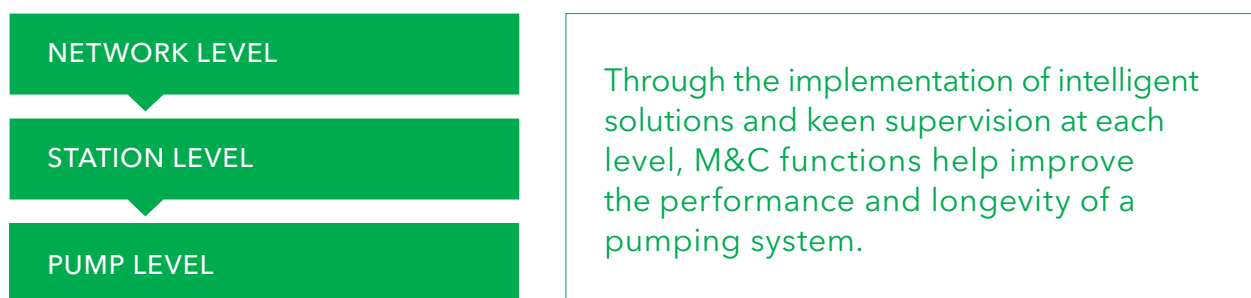

## G1

### PUMP LEVEL M&C

Smart supervision of pumps includes knowing what condition they are in. It involves controlling the pumps remotely from a centralized location within a municipality, and obtaining live updates with an overview of the pumps and pump stations in a network.

The most basic M&C functions at this level ensure the pumps in a stormwater or wastewater pump station start and stop properly. For pumps in stormwater control applications, reliable pump start is crucial. This prevents overloading of the supply power grid, which jeopardizes stormwater transportation.

Sufficient start torque is also essential. In some cases, more force is needed to move sewage in a pipe. If the viscosity of the fluid in a pipe is notably higher than clean water, it can make the start friction for the fluid column higher than normal. Long pump standstills can also increase the required start torque.

More advanced features include clog detection, pump cleaning and energy consumption optimization. Because pumps used for stormwater control typically operate for short periods of time, energy efficiency and consumption-optimization measures are rarely adopted in this case.

### Pump Starter for Pumps in Stormwater Control

Technically speaking, the finest pump starting equipment for a stormwater control application is the variable frequency drive (VFD). VFDs are normally more expensive than autotransformers and soft starters, but price difference reduces based on the size and longevity of the pump. VFDs can be used to optimize the energy usage of the drive unit over the course of a pump's lifecycle.

The following table summarizes the various types of commonly used starting equipment.

START METHOD	APPROXIMATE IN-RUSH CURRENT	ADVANTAGES	DISADVANTAGES
<b>DIRECT ON LINE</b>	6-10 Times rated current (2 to 6 pole motors)	Inexpensive High start torque	High start current
<b>STAR-DELTA START (Y-D START)</b>	1/3 of dol in-rush current	Relatively inexpensive Smaller fuses and short-circuit breaker	Cannot be used for large multi-pole motors (like 60-150 kW/80-201 hp) Low torque during start sequence Starting time is long (vs. Dol), while inrush current is present for longer time
<b>AUTO TRANSFORMER START</b>	3-5 Times rated current Tapping (50% / 65% / 80%)	Inexpensive Spare parts often quickly available	Needs a lot of space in the pump station Low torque during start sequence
<b>SOFT STARTER</b>	2.5-4 Times rated current	Relatively inexpensive Low peak start current Reliable component (compared to Y-D starter) High torque during start sequence	
<b>VARIABLE FREQUENCY DRIVE</b>	Approximately rated current	Low peak start current Reliable High torque during start sequence	Needs a lot of space in the pump station



## G2

### STATION LEVEL M&C

At station and basin level, M&C can provide the following functions:

- | Water level
- | Sump cleaning
- | Pipe cleaning
- | Maintenance run
- | Accumulated overflow volume and statistics
- | Outflow

## G3

### NETWORK LEVEL M&C

For a network of connected stations or basins, the functions of M&C are:

- | Time to spill
- | Set point profiles
- | Controlled overflow

Measuring rainfall and identifying early warning characteristics of high flows may also be implemented.

## M&amp;C FUNCTIONS THAT SHOULD BE IMPLEMENTED BEFORE, DURING AND AFTER A STORM EVENT

FUNCTION	BEFORE	DURING	AFTER
<b>MAINTENANCE RUN</b>	<p>Take action to prevent stagnant wells or basins from flooding.</p> <p>Let the pumps run from time to time to prevent seals from sticking together, avoid malfunction and minimize buildup of hydrogen sulfide resulting in foul odors.</p>	•	•
<b>POWER ANALYZER</b>	Check that power supply is working well.	Measure and monitor voltage and current to ensure reliable power supply.	•
<b>SET POINT PROFILING</b>	•	Pump controllers can shift between high-level, normal and low-level capacity mode for a pump station in a network of pump stations. The basis is for the system to allow upstream control of other pump stations. When one pump station is unable to maintain the desired level of flow pumping, it reports an overflow warning for the stations behind it. The feeding stations immediately change to Spill Avoidance Profile to maximize the capacity of the sewer system. Higher capacity means higher uptime, giving technicians more time to address the problems.	•
<b>PUMP CLEANING</b>	•	Pumps can be unclogged by putting the impeller in reverse. When clogging is detected, the pump automatically stops and begins to operate in reverse rotation to remove the blockage.	•
<b>SUMP CLEANING</b>	•	Sumps are cleaned by setting pumps down to snoring every x-pump cycle.	•
<b>OVERFLOW LOGGING</b>	•	<p>In most markets, keeping track of overflow volumes and number of overflows are required by law.</p> <p>Data loggers enable pump controllers to easily log overflow volumes and number of overflows with information on time and date. The flow can be externally measured using a flowmeter, or the pump controller can calculate the flow rates without an external flowmeter. In this case the volumes in the wet well are combined with the measured level using a level transmitter.</p>	•

FUNCTION	BEFORE	DURING	AFTER
<b>TIME TO SPILL</b>	•	<p>Sewage systems can tell operators how much time is left before an overflow will occur if the inflow conditions remain the same. This allows operators to identify when an overflow is bound to occur and decide on next steps.</p> <p>Options include: Setting point change, blocking pump station or carrying out a controlled overflow where it hurts the least.</p>	•
<b>CONTROLLED OVERFLOW</b>	•	<p>Strategic spills do less harm than unplanned spills. Smart networks with pump controllers utilizing set point profiles and inter-station communication may resolve the issue and prevent a pump station in a sensitive area from spilling. They accomplish this by allowing another station in the network to spill before the water reaches the pump station in the more sensitive area.</p>	•
<b>HIGH INFLOW TENDENCY MONITORING</b>	•	<p>Starting a pump on quick level changes enables detection of high inflow or levels rising above a specified level within a specific amount of time.</p> <p>In this case, the lead pump is pulse started. For example, the default setting may be a change of more than 10% in 2 minutes.</p>	•
<b>REMOTE CONTROL</b>	•	<p>Remote control enables auto-restart after power outages.</p>	•
<b>PIPE CLEANING</b>	•	•	<p>Run the pumps at full speed after letting the sump level rise above the normal starting point.</p>
<b>REMOTE MONITORING</b>	<p>Continuously check that system is functioning.</p>	<p>Continuously check that system is functioning.</p>	<p>Continuously check that system is functioning.</p>

## G4

### XYLEM'S OFFER FOR MONITORING AND CONTROL

Our M&C offer for stormwater management covers all the areas summarized in the figure below. As the figure illustrates, the pyramid represents Xylem's offer for the three levels of M&C: pump level, station level and network level.



The complete range of Xylem products creates the foundation at the bottom of the pyramid. Here you will find pumps, aerators, mixers and sensors. Some components such as sensors, electronics and drive units are integrated into the featured pumps.

At the next level, we offer monitoring and protective relays that connect to sensors: MiniCAS for small pumps and MAS 801 for large pumps.

At the pump and process control level, we offer products for controlling the starting and stopping of the pumps, and regulating sump levels and the flow of water.

Xylem offers market-leading products, such as SmartRun, MultiSmart, MyConnect and Flygt Concertor®. The Flygt FGC 300 and 400 used for pumps up to 5.5 kW is a prime example of a compact Panel that offers control, monitoring and power switching in one box. We also offer a wide range of level-measuring devices, such as floats, pressure sensors and ultrasonic devices that monitor pump condition and performance. MagFlux is an example of a complete range of advanced flow meters. At the top of the pyramid, our Xylem SCADA and smart monitoring systems (i.e. OutPost3, FlygtCloud and AquaView) enable the supervision and control of all the pumps and pump stations in a municipality, treatment works or industrial plant network. Xylem's specific applications for stormwater management in an urban environment are:

#### STORMWATER PUMP STATIONS

Stormwater pumps stations require their specific M&C set-up. have much lower running times compared to other water and wastewater pumps stations, despite the massive volume of the fluid that needs to be transported. Urban scrap creates another challenge for urban stormwater stations as it flushes into the system with the rainwater. This scrap can clog the pump and block the dewatering process. These require specific M&C set-up.

#### DETENTION TANKS

Stormwater is temporarily stored in detention tanks and slowly released to a treatment plant when the plant has sufficient capacity. This process requires gates, flushing systems and outlet pump stations.

Flygt's control systems are specifically developed to reduce the time and cost of operating and maintaining detention basins. They allow filling, emptying and cleaning activities to be monitored remotely, while integrating the detention basin into the overall wastewater system.

Cleaning units can be regulated according to the water levels in the basin. Stop pumps and mixers automatically as levels rise to prevent solids from becoming suspended and minimize the risk of pollution in the event of an overflow. Operators receive a text message if service or maintenance is required.

Flygt MultiSmart includes a special function that allows well mixers to be handled in three ways:



In addition to each mode, pumps can be permitted or prevented from running with the mixer.

Flygt pump controllers can be centrally operated through Xylem SCADA software, which provides detailed information and monitoring capabilities.

## COMBINED SEWAGE SYSTEMS

In combined sewage systems, it is common to use one or two small pumps for small flows and a handful of larger pumps (sometimes more than four) for rain or flood events. These systems often include generators, redundant level sensors and backup control and alarm systems.

This M&C configuration is used in pumping stations for wet weather flows in coastal areas. If pumps are not self-cleaning, use N-technology to avoid the high risk of clogging. Optimize pump sump design to properly handle sedimentation.

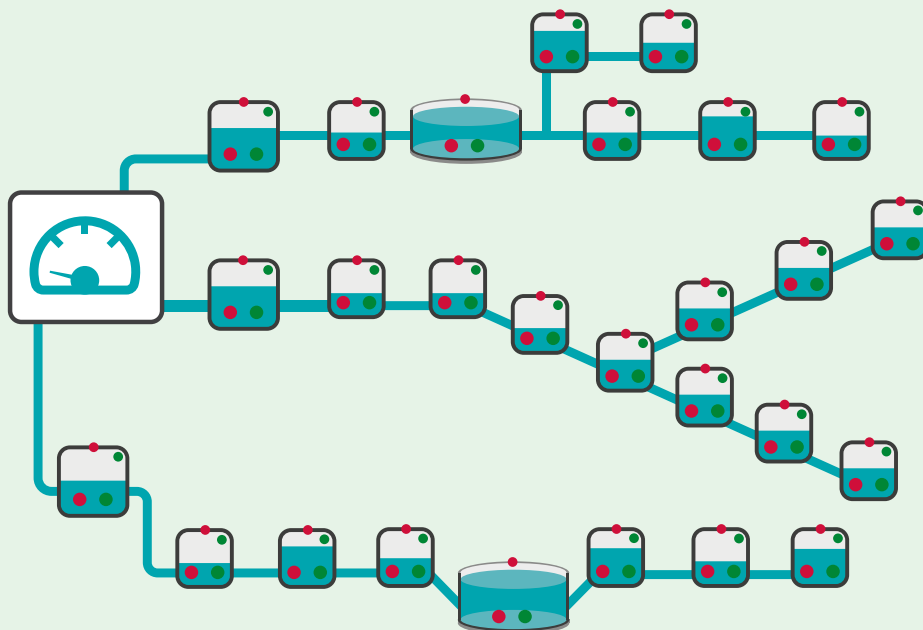

In a pumpstation network, the capacity can be utilized smartly.

If wastewater and stormwater are combined in an existing network of pump stations directed towards a treatment plant, the network will have to contend with sewage and rainwater inflow fluctuations.

Maximum inflow rates for both can be many times more than the normal rates. The pressure on the system increases during severe storms, when sediments in the system are flushed out and end up in the pump station.

Xylem can help increase the treatment capacity of combined sewage systems by coordinating the M&C between existing pumps, pump stations and treatment plants - and allowing this network to communicate through bus systems and Xylem SCADA. This helps to provide smoother inflows to the treatment plant. Xylem also leverages detention basins at the treatment plant to hold more water.

### STRATEGIC SPILLS

Piping systems may not be able to handle the entire inflow during a storm event, which causes a spill to occur. This kind of spill ends up flowing to the closest recipient (i.e. a river or the ocean).

The alternative is to carry out a controlled spill to prevent water from flowing backwards if the pipes are full. Controlled spills can reduce the risk of flooding nearby dense urban areas, critical streets and residential areas.

### INTELLIGENT PUMP FUNCTIONS

Pump, sump and pipe cleaning functions can maximize pump performance.



## OVERSIZED PUMP STATIONS

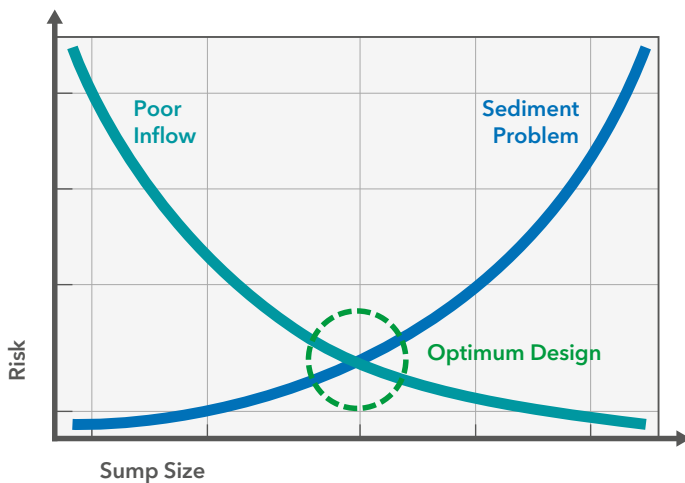

### ISSUES

Large pumps mean high energy consumption during low inflows.

Large pumps sump mean sedimentation issues.

### SOLUTIONS

Utilize the energy savings functionality of SmartRun.

Utilize sump cleaning functions in SmartRun and MultiSmart/MyConnect pump controllers.

Utilize pipe cleaning in Flygt SmartRun or Flygt PumpSmart.

If sumps are designed too small, they carry a low risk of sedimentation issues, but are susceptible to the risk of poor hydraulic and inflow conditions for the pumps. Meanwhile, large sumps create low flow regions, which increase the risk of sedimentation problems. Take these two aspects into account when determining your optimal sump size.

Resolve issues associated with extra sedimentation with the built-in pipe and sump cleaning functions of SmartRun and the well clean-out function of MultiSmart and MyConnect.

Also, with the energy-saving functionality of SmartRun (which increases energy efficiency by up to 50%), the pump station becomes more efficient during periods when there are no storms or events causing extra rainwater inflow.

## OUR BRANDS

Our brands EmNet, Sensus and Pure work with assessment, inspection, monitoring, optimization and management of main urban systems including urban watersheds and water systems.

EmNet works specifically with stormwater management for sanitary and combined sewer systems with a focus on system engineering of urban watershed management techniques.

Some of their tools are:

BLU-X™, a cloud-based Intelligent Urban Watershed platform designed and built to evoke significant improvements in performance and resiliency from legacy infrastructure.

This platform hosts a compendium of tools and applications and is able to connect to not only Xylem devices, sensors and M&C products but to all the sensors, telemetry, SCADA, GIS and hydraulic/hydrological modeling platforms on the market today.

BLU-X™ is our approach to bring together the power of the internet of things, big data analytics and machine learning to unlock unprecedented performance opportunities across urban watersheds. It mitigates sanitary and stormwater challenges, reduces overflows and basement back-ups and increases utility operators' agency over the infrastructure they are charged with managing.

Our clients often cite between 5X and 20X return on investment (and occasionally up to 100X) from working with this type of platform.

EmNet has a portfolio of control strategies, but perhaps what is most utilized and well known is its market-mimicking agent-based optimization approach. In this strategy, each control asset is governed by a computer agent, programmed with financial decision making capability in a fictional market designed by EmNet. All choices made by these agents are driven by individual supply and demand curves for collection system services, such as conveyance, storage, treatment or overflowing when relieving the system is necessary. This approach creates an efficient market within the collection system, balancing flows, minimizing surcharge conditions and achieving the highest reasonable performance and optimal capacity utilization possible from the system as a whole.



TO GET MORE INFORMATION OF THE SERVICES EMNET CAN PROVIDE FOR YOU, CONTACT YOUR LOCAL XYLEM OFFICE.



**emnet**

**SENSUS**

**pure**  
TECHNOLOGIES



**Data Collection**

- Data collection software
- Database and data analytics tools
- Full SCADA integration



**Data and Model Convergence**

- Cognitive hydraulic modelling
- Host and run real-time modelling
- Compare model results to sensor data



**Intelligent Watershed Management**

- Implement and run Global RTC
- Empower operation with RT-DSS
- Maximize performance and resiliency



## PIPE CLEANING

This feature allows the pump to be started at a fixed speed for a specific amount of time. Running them at high speeds for a short period of time clears pipes.

## PUMP GATES

For a pump gate application, the design of an integrated monitoring and control system is of vital importance. This can be achieved by combining the gates and pumps' functionalities to operate in co-ordination. This synergy is the key feature in Xylem's M&C offer.

## THE M&C SCHEME FOR A PUMP GATE SYSTEM WOULD TYPICALLY INCLUDE:

- | Control panel for pump
- | Control panel for hoist
- | SCADA
- | Smart Water platform, i.e. Xylem AquaView
- | Integrated pump gate intelligent water service platform (WeChat public number)
- | Integrated pump gate and control system including:
  - › Hydraulic, screwed or any type opening and closing methods of integrated pump gate with self-adjustable functionality
  - › The function of integrated flood control and water supply of integrated pump gate (electric control)
  - › Integrated pump brake for horizontal installation which makes maintenance and service easier

## FLOOD RELIEF

### Godwin Field Smart Technology (FST)

FST is designed by Xylem's engineers specifically for dewatering pumps. It offers added security by enabling operators to remotely turn off and lock a pump located anywhere in the world. Predictive analytics features and a built-in alarm system warn of faults in a pump and show what type of equipment is needed to resolve the issue. Pump data can be logged and documented for reporting purposes, or even linked to a SCADA system to maximize system efficiency and control.

Real-time visibility of critical performance parameters reduces the need for on-site pump monitoring, cuts manual labor costs and provides unparalleled peace of mind.



# The Interporto Bologna is one of the most important logistic platforms in Europe.

## FAST FACTS

<b>LOCATION</b>	Bologna, Emilia-Romagna Region, Northern Italy
<b>CHALLENGE</b>	To provide a complete M&C system to guarantee flood protection of a critical infrastructure
<b>APPLICATION</b>	M&C solutions for flood control
<b>RESULT</b>	Flygt AquaView, MAS 711, Flygt LSU 100 Ultrasonic Level Transmitter, MJK Shuttle Ultrasonic Level Transmitter, Flygt LTU 601 Submerged Pressure Level Transmitter, Flygt MultiSmart Pump Controller



**CASE STUDY: Interporto Bologna****CHALLENGE**

The Interporto Bologna, which spans four million square meters, is one of the most important logistic platforms in Europe. Railway and intermodal facilities occupy 66.5 Hectares (165 acres), and warehouses occupy another 60 Hectares (148 acres). This intermodal transport system is strategically designed and located to facilitate the movement of logistics, goods and operators, as well as environmental sustainability. It is positioned between three of the ten Pan-European transport corridors that connect the Mediterranean, Helsinki-Valletta and the Baltic and Adriatic seas.

The Bologna Freight Village features a railway system that extends for 665 kilometres (413 miles), an internal railway station and three rail terminals. Its innovative design is instrumental in the support and facilitation of railway systems throughout Europe. Protecting this network of infrastructure against possible flooding through monitoring and control (M&C) is critical.

**SOLUTION**

The Interporto Bologna includes a stormwater management system comprised of a detention pond, a pumping station, gates and extensive M&C capacities. During storms and rainy weather, ground water is diverted into the intake pump station, where a Shuttle and LSU 100 monitor liquid levels. The pump starts to transport ground water into the detention pond if levels reach roughly 2.6 meters (8.5 ft).

At the outflow of the detention pond, a LTU 601 monitors the water level and opens gates at a fixed height once it reaches a preset level to prevent higher outflow than the municipality can handle. The canal is camera monitored and a LSU 100 measures the water level and closes gates to the pond if it becomes too high. During warm seasons, pond water is used for irrigation of the green areas and lawns located in the logistics area.

**RESULT**

The efficient performance of all parts of the Interporto Bologna's stormwater management system have effectively protected the area from flood events.

Since the Italian-based logistic platform began operations, it has relied on Xylem as a trusted partner and provider of M&C equipment.

**Managing stormwater in rural areas presents its own unique set of challenges and requires different methods than those used in dense urban environments.**







Managing stormwater in rural areas presents its own unique set of challenges and requires different methods than those used in dense urban environments. Because these areas consist of different environmental conditions and infrastructures, stormwater management priorities and requirements are different than those discussed in the first part of this handbook.

Continue reading this section to discover how to:

Detect and forecast storms in rural areas with the latest technology.

Choose and implement the right stormwater control solutions for your rural environment.

A | DETECTING AND FORECASTING STORMS  
WITH THE LATEST TECHNOLOGY

Early warning systems are crucial to protecting human life and infrastructure during extreme weather events.



## A1

### MONITORING AND EARLY WARNING

Early warning systems are crucial to protecting human life and infrastructure during extreme weather events. Over the past half century, climate change has increased the risk of economic hazards related to extreme hydro-meteorological events by nearly 50 times.<sup>8</sup> At the same time, advances in monitoring and forecasting technology have significantly decreased losses caused by these events. Sophisticated measurement and forecasting technology is needed to predict the severity of a weather event - whether it's a hurricane, tornado or thunderstorm and mitigate damage.

Identifying and selecting the proper site and sensors are critical to the success of any stormwater monitoring project. In some cases, integrating third-party sensors may be required to ensure a complete monitoring solution can be provided for the site.

Stormwater monitoring projects can be conducted for a variety of reasons such as municipal separate stormwater and sewer system compliance, total maximum daily loads, construction impact, and a variety of perimeter monitoring scenarios for contaminants such as heavy metals.

<sup>8</sup> <https://www.wmo.int/pages/prog/drr/events/MHEWSCostaRica/Docs/FINALReportMHEWSWorkshopCostaRicaMarch2010.pdf>

## A2

### WATER POLLUTION

Stormwater plays a major part in surface water pollution. As stormwater runoff flows over surfaces, it accumulates chemicals, debris and other pollutants. Use data from stormwater monitoring to develop action plans that reduce the volumes of polluted water and minimize harm to wildlife and communities.

The unpredictability of storms can present challenges when it comes to collecting accurate, quality data. Xylem will work in conjunction, providing a total solution to ensure you meet your budget without compromising the integrity of your data.

Stormwater monitoring sites encompass a broad range of parameters from simple rainfall and turbidity measurements, typically encountered during construction practices, to complex multiparameter sites including open channel flow, level, rainfall, pH, temperature, conductivity, dissolved oxygen, turbidity, and even nutrients.





Xylem provides a range of sensors to address these challenges and produce high-quality data in near-real-time through the brands YSI, WaterLOG and SonTek. Xylem provides a range of sensors to address these challenges and produce high-quality data in near-real-time.



# A3

## XYLEM'S OFFER FOR ANALYTICS

<h3>WATER LEVEL MONITORING</h3>	<p>1</p>
<p>WaterLOG Nile Radar</p> 	<p>This instrument is designed to be mounted on bridges and platforms directly over water. It offers a non-contact water monitoring solution in a lightweight, compact solution. The reliable interface and intuitive SDI-12 communication ensure seamless integration with current monitoring stations and provide the following benefits:</p> <ul style="list-style-type: none"> <li>  An accuracy range of <math>\pm 2</math> mm (0.08 in)</li> <li>  Advanced mapping options</li> </ul>
<p>WaterLOG Compact Combo Bubbler/Pressure Sensor</p> 	<p>This built-in calibrated pressure sensor is capable of purge pressure levels up to 90 PSI in depths up to 35 meters (115 ft). It includes a display that provides a readout of the last measured value for quick reference and delivers either an automatic or manual user-defined purge.</p>
<p>WaterLOG Shaft Encoder</p> 	<p>This instrument monitors the position of a float and pulley with a magnetic sensor. It minimizes static sensitivity, allows for high-accuracy data, and includes the following features:</p> <ul style="list-style-type: none"> <li>  A built-in display with a "push to read" button</li> <li>  An absolute optical encoder that preserves correct position - even if power is lost</li> </ul>

## PRECIPITATION MONITORING

2

### Tipping Bucket Range Gauge



This solution maintains accuracy at increased rates of rainfall ranging from 0 to 635 mm. (25 in). It includes two removable stainless steel funnel screens and a rust-proof enclosure. It also has a magnetic reed bucket tip sensor and an internal leveling mechanism with a "bulls-eye" high-accuracy data.

Its built-in microprocessor automatically corrects errors, and it also provides a SDI-12 output.

## WATER QUALITY MONITORING

3

### EXO2 Multiparameter Sonde



This solution is suitable for long-term, continuous monitoring of inland and coastal applications down to depths of 250 meters (828 ft). It features wet-mateable connectors, smart sensors and an anti-fouling wiper that contains:

- | Welded titanium sensors, housings and double O-rings
- | Flexible sensor payload/configurations

## VELOCITY AND FLOW MONITORING

4

### SonTek-SL



This solution is designed specifically for side mounting on bridges, canal walls and riverbanks. It can be used in channels that are small enough to jump across, and in rivers as wide as the Amazon. It is lightweight, which makes it easy to transport and mount. It also boasts a customizable, flexible setup that suits a wide variety of applications.

### Argonaut®-XR



This product is ideal for near-shore deployment in less than 40 meters (131 ft) of water. It is designed specifically for mounting on the bottom of a river, channel or harbor and features a special mode that automatically adjusts one of its measurement cells for changing water levels. Its small size, rugged build and flexible system architecture make this solution attractive for both real-time operation and autonomous deployment.

It is also able to measure non-directional waves and includes the following features:

- | 10 water velocity cells, plus an 11th that automatically adjusts based on water level
- | 3D water velocity measurement

### SonTek-IQ®



This solution collects flow (area-velocity) and volume data in as little as 8 centimeters (3 in) of water. It is able to handle full or partially full pipe conditions, slow, and even reversing flow with ease. The five-beam pulsed Doppler design adapts to changing conditions and captures high-resolution data throughout the flow field.

It also includes the following features:

- | Self-calibrating water level monitoring with vertical acoustic beams and pressure
- | Proprietary flow algorithms for irrigation canals and natural streams



## STORMWATER DATA COLLECTION MONITORING

5

### Storm Central



This solution supports data download from any computer or mobile device with an internet connection. Custom-alarm notifications, via SMS text and/or email, inform users when a sample has been taken and warn them about other alarm criteria, such as a parameter exceeding a maximum limit. Pair Storm Center with the Storm 3 data logger with optional internal, built-in cell modem for high-quality data collection.

Storm Central offers the following benefits:

- | Less frequent site visits with automated data push from data logger
- | Secure backup of data off-site



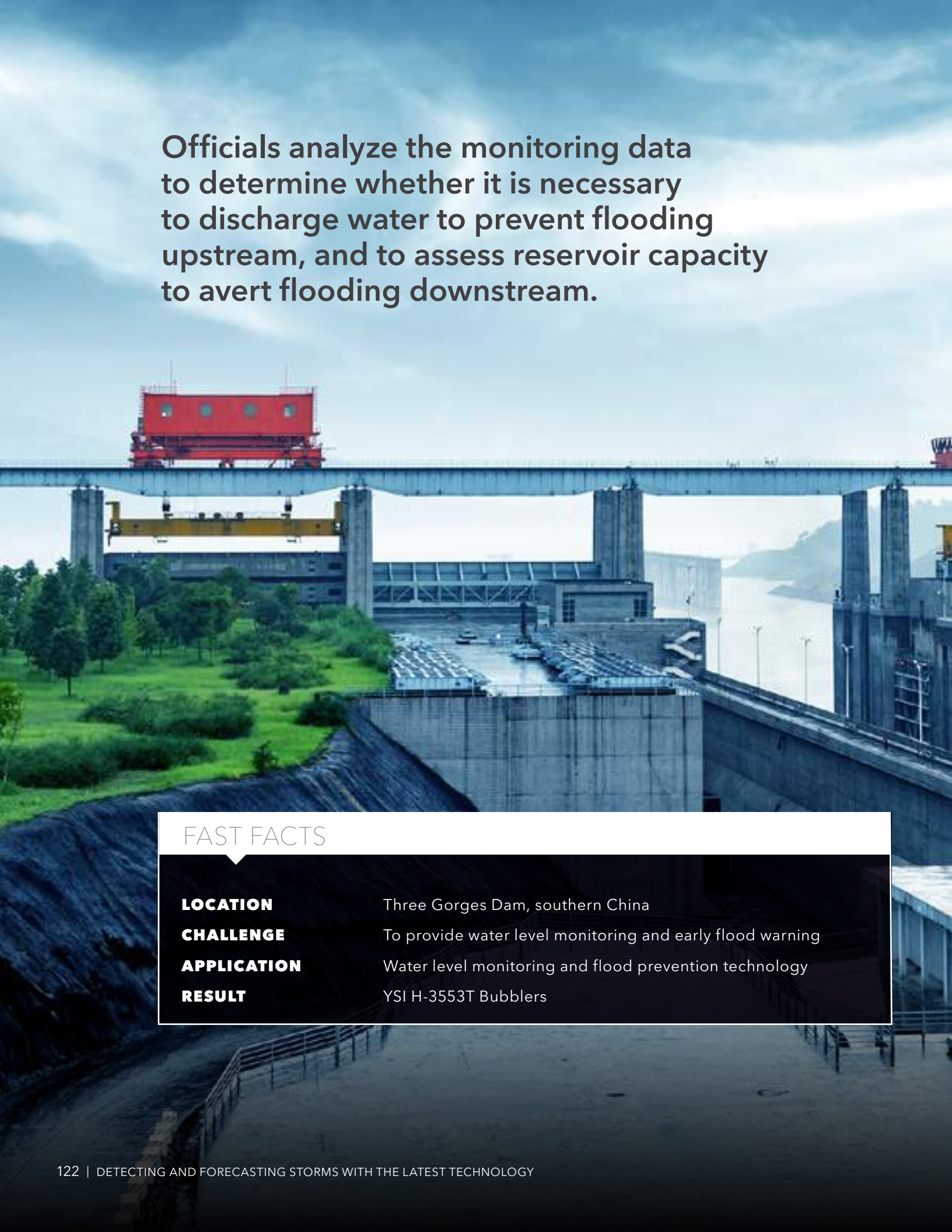

Officials analyze the monitoring data to determine whether it is necessary to discharge water to prevent flooding upstream, and to assess reservoir capacity to avert flooding downstream.

## FAST FACTS

**LOCATION**

Three Gorges Dam, southern China

**CHALLENGE**

To provide water level monitoring and early flood warning

**APPLICATION**

Water level monitoring and flood prevention technology

**RESULT**

YSI H-3553T Bubblers

## CASE STUDY: China's Three Gorges Dam

Xylem's YSI water level monitoring technology provides reliable early flood warning at the world's largest hydroelectric dam in China.

### CHALLENGE

The colossal Three Gorges dam in southern China stands 185 meters (607 ft) high and spans 2.3 kilometers (1.4 mi) in length. The world's largest hydroelectric dam was constructed to protect residents from severe flooding from the Yangtze River, provide fresh water for agricultural use and supply an environmentally-friendly source of electricity. But it has been a source of controversy during times of flooding and drought. Dam operators require a reliable monitoring system to accurately track water levels in real-time in order to provide early flood warnings, help manage drought and optimize power generation.

### SOLUTION

Xylem provided its renowned YSI H-3553T Bubbler to gather stage and flow measurements and allow dam operators to accurately monitor upstream and downstream water levels. This compact monitoring system is designed specifically for measuring fluid levels in surface water applications, groundwater and tanks. It includes a built-in, calibrated pressure sensor and a continuous display that provides readouts of the last measured value for quick reference. It uses an advanced controller, pressure regulator, sensors and valves to regulate the bubble rate and purge pressure. It also offers a purge feature to maintain pressure at the desired level.

### RESULT

YSI monitoring technology is now installed at almost 100 sites around the dam. Data collected by the system enables dam operators to gauge capacity in the reservoir ahead of a forecasted flood event and determine whether capacity is sufficient to hold the water in the dam to avoid flooding downstream. "The sensors from the monitoring sites provide key data that helps the Three Gorges Cascade Dispatch Center and Changjiang Water Resources Commission build a regional water flow model, which is used to calculate the storage capacity at the dam and estimate power generation," explains Roger Zhou of Xylem's analytics business division.

Accurate monitoring of water levels at the dam has directly and positively impacted the lives of citizens who live upstream and downstream. It continues to help ensure public safety, reduce flooding and drought and optimize power generation.

B | SELECTING THE RIGHT STORMWATER CONTROL SOLUTION

Not all stormwater management projects look the same.



Not all stormwater management projects look the same. Evaluate and select the right solution to meet your project's unique parameters and requirements - and ensure the operational efficiency of your stormwater control solution.

This section explores four areas of stormwater management in rural areas:

<b>PONDS</b>	<b>1</b>
<b>GROUNDWATER MANAGEMENT</b>	<b>2</b>
<b>HIGHWAY AND ROADSIDE RUNOFF CONTROL</b>	<b>3</b>
<b>AIRPORT DRAINAGE DESIGN</b>	<b>4</b>

# B1

## PONDS

### Retention Ponds

In rural areas with a separate stormwater collection system, runoff is collected in retention ponds or lagoons. Excess water is released at a controlled rate to prevent flooding and erosion of downstream areas.

These relatively inexpensive, artificially built ponds are primarily designed to improve stormwater quality through sedimentation regulation. When sedimentation reaches a certain height, which can take several years, it can easily be removed with an excavator during dry periods. Retention ponds and lagoons do not require any cleaning equipment.

ADVANTAGES	DISADVANTAGES	EMPTYING METHOD	CLEANING EQUIPMENT
Low investment cost	Costly operation: Require regular inspections for signs of deterioration or clogging.	Evaporation.	No cleaning equipment required. Dugout after a number of years.
Effective due to good filtration rate	Costly operation: Require a large space, may require safety fences and overflow gates.	•	•

## Detention Ponds

Dry detention ponds are either excavated or constructed in natural depressions. These reservoirs store stormwater temporarily and slowly release it into a river or ocean. It is best practice to implement detention ponds in rural areas, where stormwater is less polluted than in cities and space is abundant.

ADVANTAGES	DISADVANTAGES	EMPTYING METHOD	CLEANING EQUIPMENT
<b>Low investment cost</b>	Expensive to implement in cities with limited space.  Often require gates and inlet pump stations. Prone to sedimentation.	Usually by gravity.	No cleaning equipment required.  Cleared manually after a few years.
<b>Effective due to good filtration rate</b>	Risk of clogging and collection of waste and pollutants.	•	•

## Infiltration Ponds

Like retention ponds, infiltration ponds are more appropriate in rural areas due to the amount of space they require. They have no structural outlet or discharge, and outflow takes place via the surrounding soil.

## B2

### GROUNDWATER MANAGEMENT

Groundwater needs to be controlled and monitored to prevent contamination and significant level changes. Rising or falling groundwater levels can cause negative consequences for both infrastructure and the environment. Use a combination of quality- and quantity-control approaches to implement a successful groundwater management system.

These approaches include:

- | Preventing contamination or purifying stormwater before infiltration
- | Managing impervious and pervious surfaces
- | Applying best management practices (BMPs)
- | Installing drainage pump stations for groundwater level control

#### Controlling Groundwater Level





Groundwater drainage and control includes the removal of excess subsurface water, commonly known as drainage. Drainage systems typically include a number of small laterals that drain water to larger-diameter sub-mains and mains.

The water collected by these laterals and mains flows to an outlet point on the edge of a field, where it is discharged into an open ditch or other surface water body. Position the outlet at the point of lowest elevation in the tile system, which may be lower than the elevation of the bottom of the discharge channel. From there, water flows to a river or stream. If necessary, use a pump station to lift the water over a hill or rise between the field and the discharge channel. Polder pump stations are the most common type of station used in groundwater management.

### Polder Pump Stations

A polder is a low-lying tract of land enclosed by embankments known as dikes, which forms an artificial hydrological barrier. Water enters the low-lying polder due to the water pressure of groundwater, rainfall or rivers and canals. When the water level increases, sluices open at low tide to pump or drain the station. For optimal performance, lifting heads that are between one and five meters are commonly used. Compared to flood control pump stations, running times of polder pump stations are very high because the pump practically operates as a drainage pump.



## B3

### CONTROLLING HIGHWAY AND ROADSIDE RUNOFF

A roadside drainage system's primary purpose is to remove water from the road and its surroundings. Road drainage systems consist of two parts: dewatering and drainage. Dewatering involves the removal of rainwater from the surface of the road, while drainage consists of various infrastructure elements used to keep the road structure dry. A well-built and maintained road drainage system is a sustainable investment.

The major advantages of a good drainage system are:

- | Effective removal of rainwater from the road surface and its surroundings
- | Underlying road structures are kept dry and intact
- | Good bearing capacity
- | Safer roads

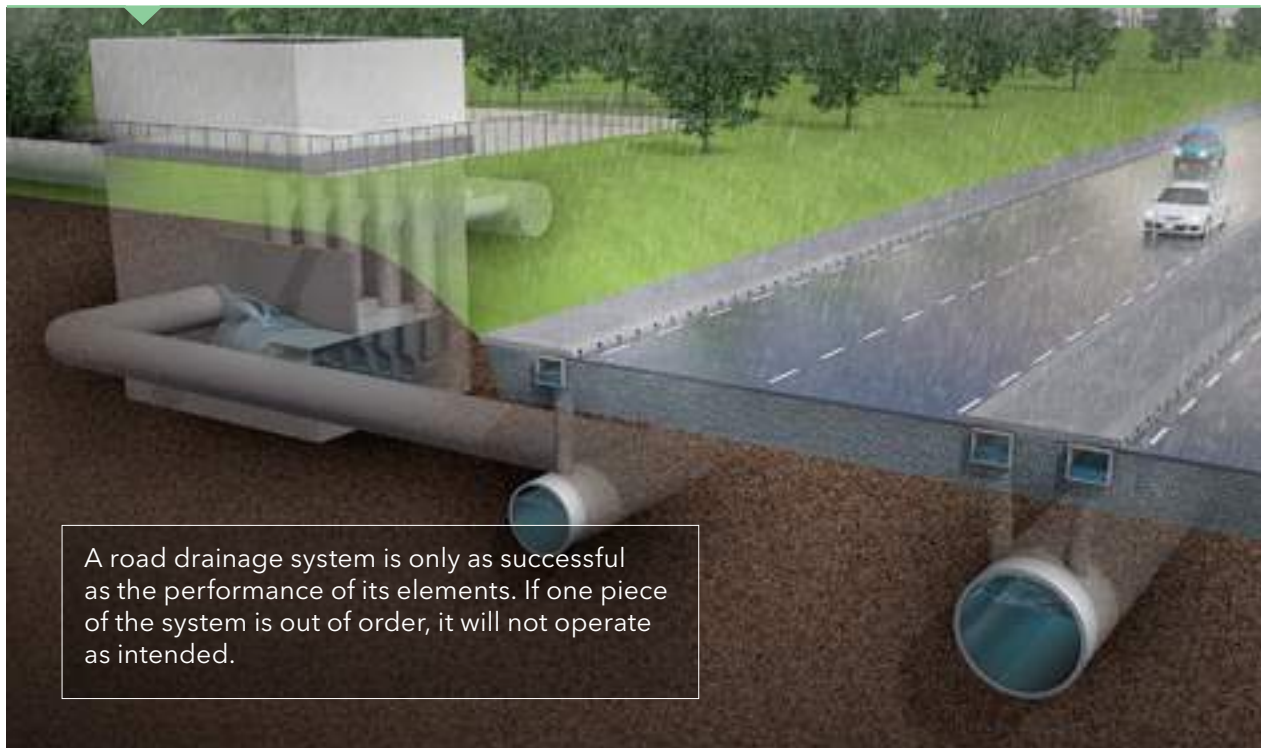

## Design Guidelines and Recommendations for Highway and Roadside Runoff

Side ditches collect road water and lead it to the outlet ditches. Water collected from ground drainage structures and the flow collected from outlet ditches are transported through the culverts. Longitudinal gradients for side ditches are defined by National Road Authority regulations (e.g. 5 mm/mi or 0.2 in/3.3ft] – according to Swedish guidelines).

**A roadside drainage system consists of several elements, and typically includes the following features:**

- | Side ditches
- | Outlet ditches
- | Under-drains
- | Culverts
- | Road structures
- | Collection system
- | Detention and retention structures
- | Pump stations

A culvert is a pipe or box structure generally used as a cross drain for ditch relief. It allows water to pass under a road at natural drainage and stream crossings. A culvert is usually shaped like a round pipe, but it can also come in pipe arch, structural arch or box shapes. The shape depends on the site, the required area and the permitted height of soil cover.

Runoff contributes to flooding and carries pollutants that degrade water quality. In addition to draining roads, roadside drainage systems intercept runoff from adjacent hill slopes and capture almost one-fifth of the runoff from each watershed. Ditches also transport road salts, fertilizers and viable pathogens from lawns and farms to streams. Unprotected ditches contain a significant amount of suspended sediment and gravel, which turn streams brown during a storm event. Ditch output disturbs the natural stream flow and causes erosion along the stream banks.

A flow-collection system of culverts and channels provides a better way to direct flow to detention and retention facilities using gravity or pump stations. These facilities control water quality before releasing it into nature.

## B4

### CONTROLLING AIRPORT RUNOFF WITH DRAINAGE DESIGN

Evaluate three types of drainage when designing an airport's stormwater management system:

- | Surface drainage directs the flow of water away from pavements and buildings; it eventually removes it from the airfield
- | Subsurface drainage removes water from underneath the pavement
- | Pavement surface drainage prevents water buildup that can cause hydroplaning



Serious accidents can occur when aircraft lose control of steering and braking. Each type of drainage needs to be sufficiently covered when designing systems for airports.

## Design Guidelines and Recommendations for Airport Runoff

Rainfall analysis and runoff estimation are the first steps of a successful airport drainage design plan. Use calculated runoff to determine the number and size of inlets and other structures.

Poor pavement subsurface drainage leads to slope instability failure and a rapid decrease in service ability level, which cause rutting, cracking and faulting. Adopt groundwater management methods to remove water from under airport pavement.

Highway sub-drainage design can be adapted to address subsurface drainage at airports. Airport runways and taxiways are similar to highways in all aspects of drainage except for the distance the water has to flow to reach the edge of the pavement.

Create a contour map of the airport and adjacent areas (including layout of runways, taxiways and aprons) to design the surface drainage system. Note general directions of flow and any natural watercourses, and locate inlet structures at the lowest points in the field area. Space these inlets so water does not have to flow too far from the farthest point in the drainage area. Connect each inlet to the major outfalls by pipelines and direct all surface flow away from the pavements - not across them.

When it comes to groundwater handling, determine the quantity of inflow from major water sources and use this calculation to inform your drainage system design. Surface infiltration is usually the largest source, but upward seepage from underlying groundwater and springs and capillary water from the water table and water from hydrogenases should also be considered.

Once water enters the structural section of the pavement, it must be drained rapidly. If water remains in the pavement structure for an extended period of time, the damaging effects increase dramatically.

Refer to the national aviation advisory circulars on airport drainage design for detailed guidelines on the design process.

## B5

**XYLEM'S OFFER FOR STORMWATER CONTROL SOLUTIONS  
OUTSIDE DENSE URBAN ENVIRONMENTS**

## Pumping

Large range of pumps, small mixers and air-water ejectors, as well as design expertise, for detention ponds. Go back to [Part One](#) for a list of products and M&C that can be used both in urban and non-urban environments.

## Groundwater Level Control

Design expertise for groundwater level control pump stations ranging from small to very large, based on the specifications of each project.

We have also developed a range of predesigned, prefabricated polder stations equipped with screens, with capacities ranging from 250- 3900 l/s ( 9-140 cfs).

These stations reduce construction time for contractors by more than 50%.

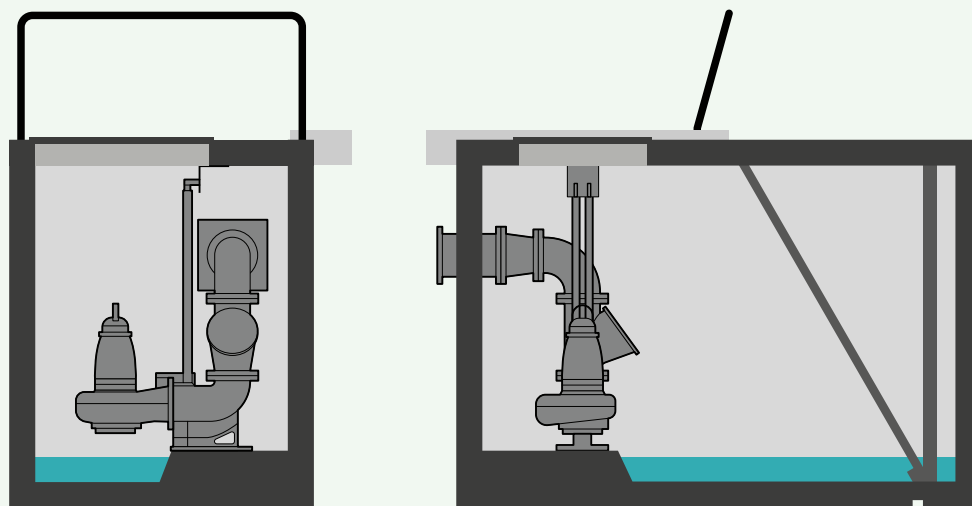

Example for a prefabricated polder station including the pump NP 3153 LT 5,9 kW, 180 l/s at 4m screens, monitoring and control cabinet. (Netherlands)

OUR MOST COMMON PRODUCT OPTIONS ARE LISTED IN THE TABLE BELOW

SUB-APPLICATION	OFFER	RANGE	OTHER
Small Polder Stations	<b>Lowara Z 8-12 Goulds VIS</b>	Flow: < 500 l/s   8 000 USgpm Head: < 500 m.   1 700 ft.	Pump Pressure: 55 bar Diameter: 203mm / 254mm / 304mm 8"   10"   12" Material: SS 1.4308 Duplex 1.4517
	<b>Flygt BS 2000</b>	Flow: < 270 l/s   4 279 USgpm Head: < 190 m.   623.4 ft.	Power: 90 kW   120.7 hp Material: Aluminum   SS Impeller High Chrome Alloyed White Cast Iron
Polder Stations	<b>Flygt C or N 3085-3800</b>	Flow: < 2 400 l/s   38 040 USgpm Head: < 20 m.   70 ft.	Power: 680 kW   912 hp Discharge: DN 80 to DN 800
	<b>Flygt PL 7000</b>	Flow: < 200 l/s   12 000 USgpm Head: < 10 m.   33 ft.	
X-Large Polder Stations	<b>Flygt Customized Column pump YDD and WCAX   WCXH</b>	Flow: 6 000 - 32 000 l/s 48 000 - 500 000 USgpm Head: < 20 m.   70 ft.	Material: Cast Steel   AISI 316 Super Duplex 254 SMO

## B6

### **XYLEM OFFER FOR ROADSIDES AND AIRPORTS**

#### **Airport and Roadside Runoff Control and Drainage Design**

Xylem offers a vast range of pumps and equipment, as well as design expertise, for design and implementation of runoff management systems for roadsides and airports.

These solutions are designed to drain, collect and transport stormwater. They assist in maintaining the reliable and acceptable performance of these infrastructures, and ensuring compliance with local regulations. Go back to [Part One](#) for a list of products and M&C that can be used both in urban and non-urban environments.







Flygt pumps have played an important part in the airport's growth since the earliest stages, and they have demonstrated more efficiency in their performance than those offered by competitors.

## FAST FACTS

<b>LOCATION</b>	Dubai, United Arab Emirates
<b>CHALLENGE</b>	Address safety and operational concerns related to rain and stormwater runoff through comprehensive management
<b>APPLICATION</b>	Design and implementation of a stormwater management system and a new pumping station
<b>PRODUCT</b>	Flygt submersible centrifugal pumps
<b>PUMP CAPACITY</b>	6,060 l/s (96.053 gpm)
<b>HEAD</b>	21 m (69 ft)



## CASE STUDY: Dubai International Airport

Xylem keeps Dubai International Airport safe and dry with a stormwater management system.

### CHALLENGE

Dubai International is the world's busiest airport in terms of international passenger traffic. In 2016, it carried over 83 million passengers.<sup>9</sup> If just two millimeters of rain fall on a single airport runway measuring 1.6 kilometers (1 mi) long and 30 yards (90 ft) wide, this amounts to roughly 90,850 liters (24,000 gallons) of water and creates a considerable challenge for airport operators. Although rainfall in the United Arab Emirates is generally low, runoff still presents a concern at Dubai International Airport. To address this concern, operators sought out an effective stormwater management system and new pumping station.

### SOLUTION

The Dubai Department of Civil Aviation enlisted Xylem to help with the design and implementation of a stormwater management system at the airport. A new pumping station was required to collect rain and stormwater runoff and pump it to a dedicated location for storage - all while maintaining compliance with local regulations.

Dubai International Airport has used Flygt pumps for a number of years, and they selected these pumps for the new project as well. Xylem provided five large submersible centrifugal pumps with 400 kilowatt(kW) motors, rated to deliver approximately 6,060 l/s (96.053 gpm) at a 21-meter (69 ft) head.

"Flygt pumps were chosen for their consistent design and performance based on the experience of other projects and installations at the airport," explains Mustafa Bawab, General Manager of Inma - Gulf Development and Construction.

### RESULT

Even small improvements in operational reliability can create lasting global benefits at a vital transport hub like Dubai International Airport.

Xylem's stormwater management solution helps support the smooth running of runway and ground infrastructure and ensures the seamless takeoff and landing of aircrafts.

<sup>9</sup> <https://airwaysmag.com/airports/dubai-airport-83-million-passengers-2016/>

C | THE IMPORTANCE OF MONITORING AND CONTROL  
OF STORMWATER MANAGEMENT IN NON-URBAN ENVIRONMENTS

We offer a variety of products and solutions for monitoring and controlling these facilities in rural and suburban areas.

Monitoring and control also plays a vital role in stormwater control facilities located outside of dense urban environments, and its functions are applied in a similar fashion. Xylem offers a variety of products and solutions for monitoring and controlling these facilities in rural and suburban areas.

# C1

## XYLEM'S OFFER FOR MONITORING AND CONTROL OUTSIDE OF URBAN ENVIRONMENTS

### Infiltration Ponds

In infiltration ponds, inflow to the pond, water quality and pond level measurement are the main monitoring and control features. Xylem through its different brands offers a variety of instruments for this purpose.





Flow	Water Quality	Level
		

## Wet Retention Ponds

These ponds are primarily built to improve the quality of water from stormwater flows. They are designed to retain water permanently - even during dry periods. Gravity usually creates inflow to wet retention ponds. In wet retention ponds also inflow to the pond, water quality and pond level measurement are the main monitoring and control features.



Flow	Water Quality	Level
		

## Dry Detention Ponds

In dry detention ponds, pump controllers are considered on top of the general inflow to the pond, water quality and pond level measurement as the main monitoring and control features. Xylem through its different brands offers a variety of instruments here also.







Pump Controller	Flow	Water Quality	Level
			

# Stormwater Management Outside of Dense Urban Environments

## Polder Pumping Stations

In polder stations, pump controllers and pump monitoring, inflow to the pond and level measurement are the main monitoring and control features. Xylem through its different brands offer a variety of instruments for this purpose.



Pump Controller	Pump Monitoring	Flow	Level
			



## Roadside M&C

Xylem also provides level controls for canals and open channel flow measurements. In roadside stations, similar to polder stations, pump controllers and pump monitoring, inflow to the pond and level measurement are the main monitoring and control features.



### Pump Controller



### Pump Monitoring



### Flow



### Level



## FAST FACTS

**LOCATION**

New Jersey, USA

**CHALLENGE**

To help the state recover from Superstorm Sandy and improve long-term resilience

**APPLICATION**

A series of pumps and controllers deployed along a 19 km (12 miles) stretch of Route 35, a highway that runs along New Jersey's coastline and connects many island towns

**PRODUCT**

50 powerful Flygt Slimline submersible propeller pumps and another 27 smaller submersible pumps in nine stations



## CASE STUDY: New Jersey Shore

Xylem helps protect coastline along the New Jersey shore with innovative pump station solutions.

## CHALLENGE

Route 35 is not your typical road winding down the New Jersey shore. It serves as the transportation lifeline for island towns like Bay Head and Mantoloking, which sit on a sliver of land between the ocean and the bay. Superstorm Sandy tore through these towns and ripped up Route 35. In the storm's aftermath, the New Jersey Department of Transportation made immediate stopgap repairs to reopen the road. It also implemented Xylem technology to ensure the rebuilt roadway will be able to withstand the most intense weather events moving forward.

## SOLUTION

Xylem pumps and controllers play a pivotal role in making Route 35 a safer and stronger highway. The road redesign includes improvements to the pavement, utilities and landscaping, but a new drainage system featuring Xylem products is the key to storm-proofing this vulnerable stretch of Route 35. As part of the \$265 million reconstruction project, Xylem will supply nearly 50 powerful Flygt Slimline submersible propeller pumps and another 27 smaller submersible pumps in nine stations along a 19-kilometer (12-mile) stretch of the highway.

These pumps are located in concrete-encased stations underneath the road, and are capable of working underwater. Each Slimline propeller pump can move 568 l/s (9,000 gpm). If a storm overwhelms the regular drainage sewers, these pumps will kick in and push excess water back into the bay.

"There's not a lot of room for these pump stations under the road, so the unique small-footprint design of our Flygt Slimline pumps was a big plus for the contractors working on this project," says Mark Umile, Manager of the Xylem sales branch located in Malvern, Pennsylvania - about 160 kilometers (100 mi) from the New Jersey coast. "It allowed them to design smaller concrete vaults for the pump stations" - thereby reducing capital costs even further.

Each pump station is connected to a MultiSmart control panel located 3.7 meters (12 ft) above the ground to protect it from storm surges. These pre-programmed control panels coordinate the operation of the multiple pumps inside each station and manage them with ease.

"You don't need to hire someone to control the pumps or create a custom control system for each pump station," says Chuck Narod, a Xylem sales representative in the United States.

"For this job, one MultiSmart controller can be programmed quite easily to run the multiple Xylem pumps down in the pump station to ensure we're getting out as much water as possible, as fast and efficiently as possible."

#### RESULT

Xylem isn't just helping New Jersey recover from Superstorm Sandy; we're improving the state's long-term resiliency and many benefits won't be fully realized for years to come.

"Our company doesn't just sell products and walk away from the job," says Umile. "We're an industry leader with a large service department that's going to be here when we're needed. So, while we're solving a problem for the state today, New Jersey is also going to find out years from now that we are still here to help them out. They might not know it today, but they'll find out tomorrow when another huge storm hits and they need somebody they can depend on to help them get through it. That's where we come in. And that feels good."

**Xylem pumps and controllers play a pivotal role in making Route 35 a safer and stronger highway.**









# Xylem ['zīləm]

- 1) The tissue in plants that brings water upward from the roots
- 2) A leading global water technology company

We're a global team unified in a common purpose: creating innovative solutions to meet our world's water needs. Developing new technologies that will improve the way water is used, conserved, and re-used in the future is central to our work. We move, treat, analyze, and return water to the environment, and we help people use water efficiently, in their homes, buildings, factories and farms. In more than 150 countries, we have strong, long-standing relationships with customers who know us for our powerful combination of leading product brands and applications expertise, backed by a legacy of innovation.

**For more information on how Xylem can help you, go to [www.xyleminc.com](http://www.xyleminc.com)**



# xylem

Let's Solve Water

Xylem, Inc.  
14125 South Bridge Circle  
Charlotte, NC 28273  
Tel 704.409.9700  
Fax 704.295.9080  
855-XYL-H2O1 (855-995-4261)  
[www.xyleminc.com](http://www.xyleminc.com)