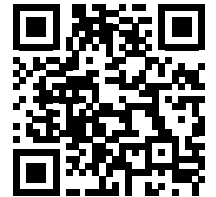


Additional Installation, Operation, and
Maintenance Instructions

P2007013_3.0



optimize®

Table of Contents

| | | |
|-------|---|----|
| 1 | Introduction and Safety..... | 3 |
| 1.1 | Introduction..... | 3 |
| 1.2 | Safety terminology and symbols..... | 3 |
| 1.3 | User safety..... | 4 |
| 1.4 | Environment protection..... | 4 |
| 1.5 | Battery safety and disposal..... | 4 |
| 1.6 | Spare parts..... | 4 |
| 2 | Transportation and Storage..... | 5 |
| 2.1 | Examine the delivery..... | 5 |
| 2.1.1 | Examine the package..... | 5 |
| 2.1.2 | Examine the unit..... | 5 |
| 2.2 | Storage guidelines..... | 5 |
| 3 | Product Description..... | 6 |
| 3.1 | Usage..... | 6 |
| 3.2 | Features..... | 6 |
| 3.3 | Compatibility..... | 6 |
| 3.4 | Parts..... | 6 |
| 4 | User Interface..... | 7 |
| 4.1 | Common icon..... | 7 |
| 4.2 | Main menu..... | 8 |
| 4.3 | Asset health menu..... | 8 |
| 4.4 | Asset details menu..... | 9 |
| 5 | Installation..... | 10 |
| 5.1 | Precautions..... | 10 |
| 5.2 | Mounting options..... | 10 |
| 5.3 | Requirements..... | 10 |
| 5.3.1 | Standard magnetic mounting..... | 10 |
| 5.3.2 | Flat plate mounting..... | 11 |
| 5.3.3 | Temperature sensor..... | 11 |
| 5.4 | Install the standard magnetic mounting..... | 11 |
| 5.5 | Prepare the flat plate mounting..... | 11 |
| 5.6 | Install the flat plate mounting..... | 11 |
| 5.7 | Install the optimize sensor..... | 12 |
| 5.8 | Install the pressure sensor..... | 12 |
| 6 | Operation..... | 14 |
| 6.1 | Precautions..... | 14 |
| 6.2 | Download the optimize application..... | 14 |
| 6.3 | Register the user..... | 14 |
| 6.4 | Start the application..... | 14 |
| 6.5 | Activate the sensor..... | 14 |
| 6.6 | Set up the configuration mode..... | 15 |
| 6.7 | Connect a mobile phone to the sensor..... | 15 |
| 6.8 | Configure the sensor..... | 15 |
| 6.9 | Configure the asset..... | 16 |
| 6.10 | Vibration threshold selection..... | 16 |

| | | |
|--------|---|----|
| 6.11 | LED Status on optimize sensor..... | 16 |
| 6.12 | Add a wireless pressure sensor to the system..... | 17 |
| 6.12.1 | Prerequisites..... | 17 |
| 6.12.2 | Add the pressure sensor..... | 17 |
| 6.12.3 | Remove the pressure sensor..... | 17 |
| 6.13 | optimize Sensor firmware updates..... | 18 |
| 7 | Maintenance..... | 19 |
| 7.1 | Replace the battery..... | 19 |
| 7.1.1 | Remove the battery..... | 19 |
| 7.1.2 | Clean the gasket groove..... | 19 |
| 7.1.3 | Install the battery..... | 20 |
| 7.1.4 | Install the cover..... | 20 |
| 7.2 | Replace the pressure sensor battery..... | 20 |
| 8 | Troubleshooting..... | 21 |
| 8.1 | Symptoms and remedies..... | 21 |
| 9 | Technical Specification..... | 23 |
| 9.1 | Dimensions..... | 23 |
| 9.1.1 | optimize sensor dimensions..... | 23 |
| 9.1.2 | optimize pressure sensor dimensions..... | 23 |
| 9.2 | Approvals..... | 24 |
| 9.3 | Environmental requirements..... | 24 |
| 9.4 | Surface temperature measurement..... | 24 |
| 9.5 | Vibration measurement..... | 24 |
| 9.6 | Power..... | 25 |
| 9.7 | Wireless communication..... | 25 |
| 9.8 | Physical properties..... | 25 |
| 9.9 | Part numbers..... | 26 |
| 10 | Product Warranty..... | 27 |
| 11 | Cybersecurity..... | 28 |
| 11.1 | Xylem Product Cybersecurity..... | 28 |
| 11.2 | Optimize Security Features..... | 28 |
| 11.3 | Optimize Security Recommendations for End-User..... | 29 |
| 12 | Certifications..... | 31 |
| 12.1 | optimize device: For US and Canada only..... | 31 |
| 12.1.1 | FCC/IC statement..... | 31 |
| 12.1.2 | CAN ICES-3 (A)/NMB-3(A)..... | 31 |
| 12.1.3 | FCC / IC RF radiation exposure statement..... | 31 |
| 12.1.4 | UL and cUL listed (E516095)..... | 31 |
| 12.2 | optimize device: For EU countries..... | 31 |
| 12.2.1 | RF radiation exposure statement..... | 31 |
| 12.2.2 | WEEE 2012/19/EU Notice..... | 31 |
| 12.3 | optimize pressure sensor: For US and Canada only..... | 32 |
| 12.3.1 | FCC/IC statement..... | 32 |
| 13 | Declaration of Conformity..... | 33 |
| 13.1 | EU Declaration of Conformity..... | 33 |

1 Introduction and Safety

1.1 Introduction

Purpose of the manual

The purpose of this manual is to provide the necessary information for working with the unit. Read this manual carefully before starting work.

Read and keep the manual

Save this manual for future reference, and keep it readily available at the location of the unit.

Intended use



WARNING:

Operating, installing, or maintaining the unit in any way that is not covered in this manual could cause death, serious personal injury, or damage to the equipment and the surroundings. This includes any modification to the equipment or use of parts not provided by Xylem. If there is a question regarding the intended use of the equipment, please contact a Xylem representative before proceeding.

1.2 Safety terminology and symbols

About safety messages

It is extremely important that you read, understand, and follow the safety messages and regulations carefully before handling the product. They are published to help prevent these hazards:



- Personal accidents and health problems
- Damage to the product and its surroundings
- Product malfunction

Hazard levels

| Hazard level | Indication |
|-----------------|--|
| DANGER: | A hazardous situation which, if not avoided, will result in death or serious injury |
| WARNING: | A hazardous situation which, if not avoided, could result in death or serious injury |
| CAUTION: | A hazardous situation which, if not avoided, could result in minor or moderate injury |
| NOTICE: | Notices are used when there is a risk of equipment damage or decreased performance, but not personal injury. |

Special symbols

Some hazard categories have specific symbols, as shown in the following table.

| Electrical hazard | Magnetic fields hazard |
|--|---|
|  <p data-bbox="583 176 768 205">Electrical Hazard:</p> |  <p data-bbox="1127 176 1240 205">CAUTION:</p> |

1.3 User safety

All regulations, codes, and health and safety directives must be observed.

The site

- Observe lockout and tagout procedures before starting work on the product, such as transportation, installation, maintenance, or service.
- Pay attention to the risks presented by gas and vapors in the work area.
- Always be aware of the area surrounding the equipment, and any hazards posed by the site or nearby equipment.

Qualified personnel

This product must be installed, operated, and maintained by qualified personnel only.

Protective equipment and safety devices

- Use personal protective equipment as needed. Examples of personal protective equipment include, but are not limited to, hard hats, safety goggles, protective gloves and shoes, and breathing equipment.
- Make sure that all safety features on the product are functioning and in use at all times when the unit is being operated.

1.4 Environment protection

Emissions and waste disposal

Obey the local laws and standards in the following cases:

- Report the emission details to the applicable authorities.
- Sort, recycle, and dispose the solid or liquid waste on time.
- Clean the spilled liquid on time.

1.5 Battery safety and disposal



WARNING:

Do not crush, puncture, short, or expose batteries to a temperature above +85°C (185°F). Only use batteries supplied by Xylem Inc. for replacement. Do not ingest batteries, chemical burn hazard.

This product contains two replaceable lithium batteries. Consult the product instruction manual for replacement guidelines. All batteries must be disposed in an environmentally sound manner according to local regulations. Consult your local waste-management officials for information on how to safely dispose of used batteries.

1.6 Spare parts



CAUTION:

Only use the manufacturer's original spare parts to replace any worn or faulty components. The use of unsuitable spare parts may cause malfunctions, damage, and injuries as well as void the warranty.

2 Transportation and Storage

2.1 Examine the delivery

2.1.1 Examine the package

1. Examine the package for damaged or missing items upon delivery.
2. Record any damaged or missing items on the receipt and freight bill.
3. If anything is out of order, then file a claim with the shipping company.
4. If the product has been picked up at a distributor, make a claim directly to the distributor.

2.1.2 Examine the unit

1. Remove packing materials from the product.
Dispose of all packing materials in accordance with local regulations.
2. To determine whether any parts have been damaged or are missing, examine the product.
3. If there is any issue, then contact a sales representative.

2.2 Storage guidelines

Storage location

The product must be stored in a covered and dry location free from heat, dirt, and vibrations.

NOTICE:

Protect the product against humidity, heat sources, and mechanical damage.

NOTICE:

Do not place heavy weights on the packed product.

3 Product Description

3.1 Usage

optimize^{® 1} is a condition monitoring application that gives health guidance and predictive maintenance advice for the following rotating and fixed assets:

- Pumps
- Heat exchangers
- Motors
- Steam traps

Asset health data is stored in the xylem cloud and can be shared with multiple users

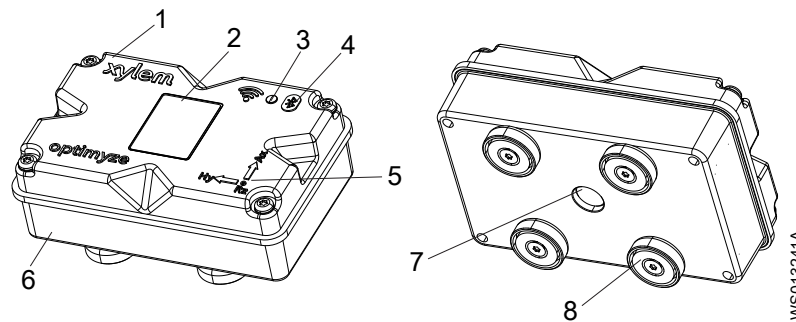
3.2 Features

- Periodic measurement of asset vibration (three axis), temperature and pressure (optional)
- Uses the Bluetooth[®] wireless technology² to communicate the health and operating data to a smart device or gateway
- Shares data automatically with other local users through cloud
- Shows the asset health by using a traffic light warning system
- Graphical trending and waveform analysis
- Generates reports
- Shows maintenance logs
- Library of product documentation (IOM, data sheet, and parts)
- Schedules the routine preventive maintenance of assets

3.3 Compatibility

- iOS
- Android

3.4 Parts



1. Upper cover
2. QR code
3. LED
4. Bluetooth[®] icon
5. Axis alignment guide
6. Lower cover
7. Infrared (IR) sensor window
8. Magnetic feet




















¹ optimize[®] is a trademark of Xylem, Inc. or one of its subsidiaries. All other trademarks or registered trademarks are property of their respective owners.



² The Bluetooth[®] word mark and logos are registered trademarks owned by Bluetooth SIG, Inc. and any use of such marks by Xylem Inc is under license. Other trademarks and trade names are those of their respective owners.

4 User Interface

4.1 Common icon






The following icons are shown on the home page:

| Icon | Color | Description |
|---|--------|--|
|  | - | Show the following pages: <ul style="list-style-type: none"> • Dashboard • View reports • View reminders • Setting • Contact us |
|  | - | Allows the user to email information |
|  | - | Displays the notifications and warnings |
|  | - | Allows the user to add new asset or sensor |
|  | Green | Shows that the asset health is satisfactory |
| | Yellow | Shows that the asset health has deteriorated |
| | Red | Shows that the asset health has become critical |
|  | Green | Shows that the asset temperature is normal |
| | Red | Shows that the asset temperature is more than the recommended limit |
|  | Green | Shows that the asset vibration is normal |
| | Yellow | Shows that the asset vibration has increased to warning level |
| | Red | Shows that the asset vibration has increased to critical level |
|  | Green | Shows that the battery level is normal |
| | Red | Shows that the battery level is low |
|  | - | Shows that the new data has been uploaded from the sensor today |
|  | - | Shows that the new data has not been uploaded from the sensor today |
|  | - | Shows the following parameters in the asset details menu: <ul style="list-style-type: none"> • Reports • Maintenance • Reminders • Asset Setting • Documents |
|  | - | Allows the user to edit the information |
|  | - | Allows the user to delete the information or item |
|  | - | Allows the user to select a calendar date |
|  | - | Shows the drop-down list |
|  | - | Allows the user to capture or upload photo |
|  | Blue | Allows the user to enable feature |
|  | Gray | Allows the user to disable feature |
|  | - | Allows the user to change the language of the application |

| Icon | Color | Description |
|---|--------|---|
|  | Green | Shows that the pressure monitoring system is satisfactory |
| | Yellow | Shows that the pressure monitoring system has deteriorated |
| | Red | Shows that the pressure monitoring system has become critical |
|  | Green | Shows that the asset pressure values are normal |
| | Yellow | Shows that the pressure value has reached to warning level |
| | Red | Shows that the pressure value has reached to warning level |

4.2 Main menu

The  icon contains the following tabs:

| Icon | Tab | Function |
|---|-----------------------|--|
|  | Dashboard | Shows the following parameters of the assets and sensors: <ul style="list-style-type: none"> • Health of the assets • Battery life of the sensor • Status of the data synchronization |
|  | View reports | Allows the user to view and share the reports |
|  | View reminders | Allows the user to view the maintenance reminders |
|  | Setting | Allows the user to edit the user profile information and application settings |
|  | Contact us | Shows the email ID and phone number of the local sales and service representative Allows the user to send the log history to the local sales and service representative |

4.3 Asset health menu

The menu show the following parameters of sensors and assets:

| Parameter | Description |
|--|---|
| Temperature | Shows the last recorded temperature Allows user to access the trend chart |
| Vibration Radial, Axial, and Horizontal | Shows the last recorded RMS vibration level Allows user to access the vibration trend charts for RMS, Kurtosis, and FFT |
| Battery life | Shows the last recorded battery level Allows user to access the trend chart |
| Force read | Forces the sensor to collect the last data read by the device immediately |
| Pressure | Shows the last recorded pressure values Allows user to access the trend chart |


Each asset shows the following parameters:

- Asset picture
- Name
- Location
- Sensor icon

The sensor icon changes color according to the health of the asset.

For more information, see [Common icon](#) on page 7.

4.4 Asset details menu

The  icon contains the following tabs:

| Tab | Function | Description |
|----------------------|--|---|
| Reports | Allows the user to create, view, and share reports for a specific asset | - |
| Maintenance | Allows the user to create and view the maintenance logs for a specific asset | - |
| Reminders | Allows the user to create and view the maintenance reminders for a specific asset | Notifications must be turned on in the settings to create and receive reminders |
| Asset Setting | <p>Asset setting shows the following parameters:</p> <ul style="list-style-type: none"> • Image of the asset • Asset name • Manufacturing date • Model • Sensors • The sensor setting page shows the following parameters: <ul style="list-style-type: none"> – Learning mode – Manufacturing date – Sensor Placed on – Sensor placed on the part – Vibration Standard – Classification – Asset size – Sampling frequency • Allows the user to select one of the following options for the Sensor placed on the part: <ul style="list-style-type: none"> – NDE Bearing (Non-drive end) – DE Bearing (Drive end) – Motor and Other | <ul style="list-style-type: none"> • The asset size and classification selects the approved vibration thresholds for normal operation. For more information, see Vibration threshold selection on page 16. • If an incorrect power rating or classification is selected, the sensor may show the inaccurate warnings or alarms. • Learning mode reads the natural steady state properties of the asset. • The normal condition is selected during the learned time period that displays on the temperature and RMS plots as other color bands. • After initial setup, the sensor must be in configuration mode to edit the sensor settings. For more information, see Set up the configuration mode on page 15. |
| Documents | Shows the product-specific information, literature, and data | - |

5 Installation

5.1 Precautions

Before starting work, make sure that the safety instructions in the chapter *Introduction and Safety* on page 3 have been read and understood.



WARNING:

All work must be performed by qualified personnel trained in the proper application, installation, and maintenance of the equipment.



WARNING:

Always disconnect and lock out power to the sensor before you perform any installation or maintenance tasks. Failure to disconnect and lock out power will result in serious physical injury or property damage.



WARNING:

Failure to follow all instructions can result in a fire hazard which may cause personal injury or property damage.



WARNING:

Magnetic Hazard. Magnetic fields can damage cardiac pacemaker and other medical implants.

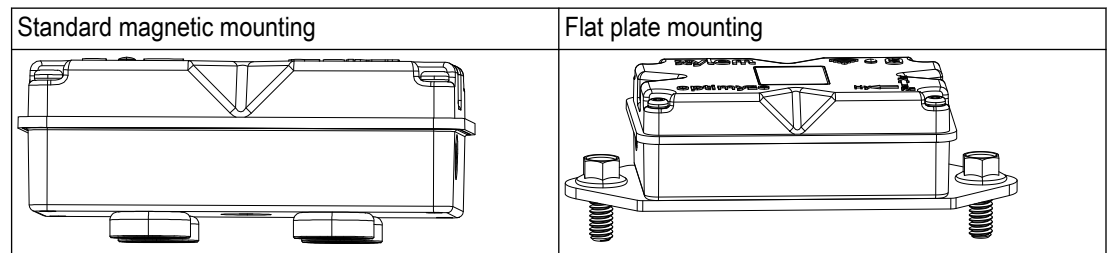


WARNING:

The magnets in the sensor feet are extremely powerful. Beware of serious injury to fingers and hands. When not in use, keep magnetic (ferrous) components and magnetized tools apart by a minimum of 1 m (3 ft).

5.2 Mounting options

One of the following mountings must be used to install the sensor on a pump or motor:



5.3 Requirements

5.3.1 Standard magnetic mounting

- The standard magnetic mounting must be installed on ferrous metals.
- The sensor must be mounted near bearings or other sources of vibration and increase in temperature.
- The standard magnetic mounting cannot be installed on special alloys or stainless steels.

- Before the sensor is installed, the pump or motor surface must be cleaned.
- If there is no correct surface to install the standard magnetic mounting, use the flat plate mounting.

5.3.2 Flat plate mounting

- The flat plate mounting can be used where the mounting surface is non-ferrous.
- The sensor must be mounted near bearings or other potential sources of vibration and increase in temperature.
- For true close-coupled pumps, the mounting location must be near the motor bearings.
- There must be sufficient space to remove the sensor and mounting plate safely without harm or injury.

5.3.3 Temperature sensor

- The infrared sensor window must be in direct line of sight with the surface of the asset being measured.
- Avoid installation of the sensor on any sheet metal enclosures surrounding the asset.
- The sensor must be mounted near bearings or other potential sources of vibration and increase in temperature.
- Follow the correct sensor orientation guidelines.

For more information, see [Install the optimize sensor](#) on page 12

5.4 Install the standard magnetic mounting

1. Install the standard magnetic mounting on one of the following surfaces of the asset:
 - Flat and dry
 - Curved: The minimum diameter must be 180 mm (7 in).
2. Check that the mounting is stable on the asset surface.

5.5 Prepare the flat plate mounting

1. On the asset, locate the surface to install the mounting.
2. Put the mounting plate on the location.
3. Use the outer most holes in the mounting plate to mark the position of holes on the surface of the asset.
4. Drill the holes at the marked position.
 - The flat plate mounting requires a size M6 or 1/4 in -20 tap.
 - The diameter of the hole must be 5 mm or 13/64 in.
 - The depth of hole must be 13 mm or 1/2 in.
 - The distance between the holes must be 105 mm (4.1 in).
5. Deburr the holes.
6. Use a M6x1 (1/4 in - 20) threading to tap the holes.

5.6 Install the flat plate mounting

1. Remove the magnetic mounting feet from the sensor.
2. Put the sensor face down.

The infrared sensor window must not be blocked.
3. Put the flat plate mounting on the sensor.

The countersunk holes must face away from the sensor.
4. Align the four screw holes of the flat plate mounting and four blind holes of the sensor housing.

For more information, see [Install the optimize sensor](#) on page 12.
5. Install the screws.

6. Use a torque wrench to tighten the screws.
The torque must be 0.88 Nm (7.8 lbf.in).
7. Install the flat plate mounting and sensor on the pump.
8. Tighten the screws.
9. Check that the mounting is stable on the asset surface.
The mounting must be stable to obtain the accurate vibration data.

5.7 Install the optimize sensor

Install the sensor on the pump or motor surface in one of the following correct positions:

Table 1: Default position

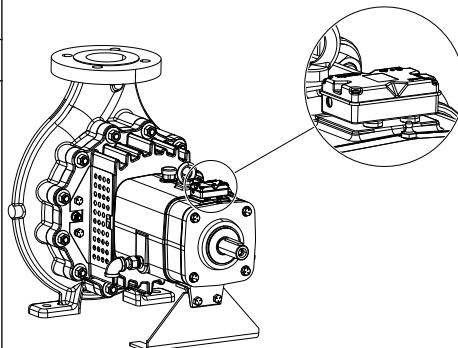
| Axis | Align | Position |
|------|---------------------------|--|
| X | Axially to the shaft |  |
| Y | Horizontally to the shaft | |
| Z | Radially to the shaft | |

Table 2: Alternate positions

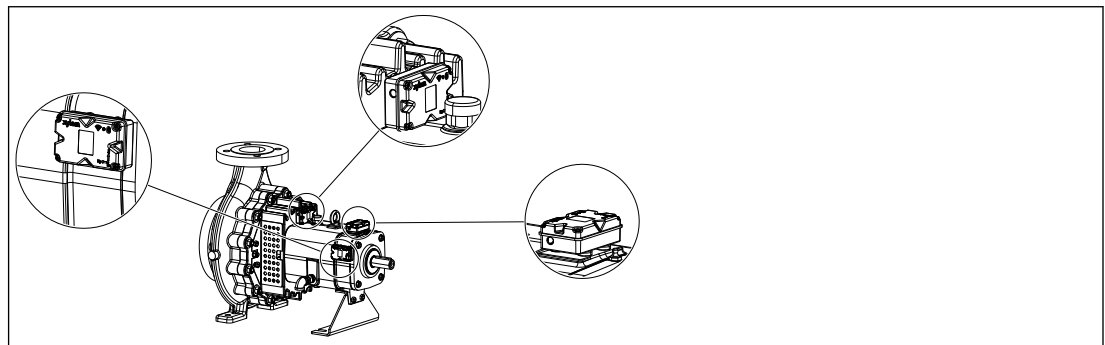
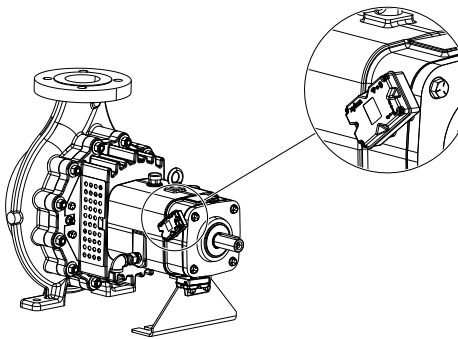
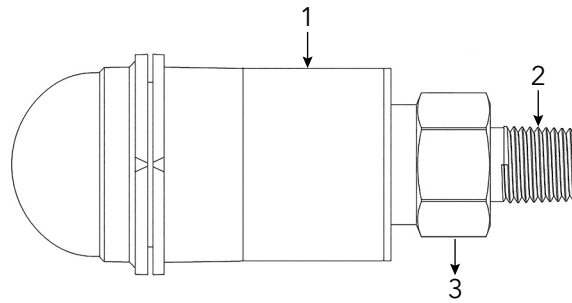


Table 3: Incorrect position

| Axis | Align | Position |
|------|-------------------------------------|--|
| X | Not aligned to major vibration axis |  |
| Y | | |
| Z | | |

5.8 Install the pressure sensor

All optimize wireless pressure sensors are equipped with a ¼" NPT male threaded fitting.



1. Sensor casing
2. 1/4" NPT male
3. 7/8 Hex nut

1. Wrap the pressure sensor pipe fitting with Teflon tape to ensure a tight seal.
2. Mount the pressure sensor onto a 1/4" NPT female fitting located on both the suction and discharge sides of the system if the differential pressure needs to be monitored. Or screw the sensor to the access valve of the system that requires monitoring.
3. Use a hex wrench to securely fasten the hex nut positioned above the fitting.
Do not use the pressure sensor casing to apply torque.

6 Operation

6.1 Precautions

Before starting work, make sure that the safety instructions in the chapter [Introduction and Safety](#) on page 3 have been read and understood.

6.2 Download the optimize application

Download the **optimize** application by using one of the following methods:

- Search for the Xylem **optimize** application in the application store.
- Scan the QR code by using the mobile camera to go to the application store.



6.3 Register the user

1. On the landing page, tap the **Register** button.
2. If the user already has a Xylem cloud account, register by using the existing details.
3. On the **Register** page, follow these steps.
 - a) Type the following information:
 - **Email ID**
 - **Phone number**
 - b) Select the **Country code**.
 - c) Tap **Register**.

An email with the verification link is sent to the user.
4. Click the verification link to validate the email address.

A set password window appears.
5. Type the password.
6. Click **Set Password**.

6.4 Start the application

1. Go to the **optimize** application.
2. Type the following information:
 - Email address
 - Password
3. Tap **Login**.

6.5 Activate the sensor

Put the magnet in the handle of the supplied screwdriver on the Bluetooth® icon to activate the sensor.

The LED blinks white light shows that the sensor is awake from the sleep mode.

The LED blinks yellow light until the sensor is put in configuration mode.

If the sensor is not set to configuration mode in 2 minutes, the sensor goes into sleep mode.

6.6 Set up the configuration mode

Hold the magnet in the handle of the supplied screwdriver on the Bluetooth® icon to set up the configuration mode.

The LED blinks pink light shows that the configuration mode is on.

6.7 Connect a mobile phone to the sensor

1. Before connecting the mobile phone to sensor, check that the following procedures are completed:
 1. Bluetooth wireless technology is enabled.
 2. Camera permission is allowed for the **optimize** application.
2. On the **Asset health** page, tap the **+** icon.
3. On the **Add a sensor** page, select one of the following options:

| Entry | Action |
|--------------|--|
| QR code | Use the mobile phone camera to scan the QR code on the sensor. |
| Manual entry | Type the nine-digit serial number The serial number is located below the QR code . |

4. Tap **Enter**.
A blinking blue LED shows that the mobile phone is connected to the sensor.
5. On the **Bluetooth Pairing Request** screen, tap the **Pair** button.

6.8 Configure the sensor

On the **Sensor configuration** page, follow these steps to configure the sensor.

- a) Select the **Installation date**.
- b) Select the following parameters from the drop-down list:
 - **Sensor Placed on**
 - **Sensor placed on the part**
- c) Select one of the following **Vibration Standard**:
 - **ISO**
 - **ANSI/HI**
 - **User Defined**

For more information, see [Vibration threshold selection](#) on page 16.


- d) Select the following parameters from the drop-down list:

| Parameter | Description |
|----------------------------------|---|
| Classification | Defines the vibration monitoring threshold |
| Asset size | For more information, see Vibration threshold selection on page 16. |
| Sampling frequency | Shows the period in which sensor collects the data |
| Set up axis for vibration | For more information, see Install the optimize sensor on page 12. |

- e) Tap on **Add an asset** button.

6.9 Configure the asset

On the asset configuration page, follow these steps to configure the asset.

- a) Type the asset name.
- b) Select the **Manufacturing date**.
- c) Select the asset location from the drop-down list.
- d) Tap the  icon to add an image of the asset.
- e) Select the asset model from the drop-down list.
- f) Tap **Save** button.

6.10 Vibration threshold selection

| Pump category | Standard | Pump type | Vibration velocity (mm/s) and LED color | | |
|---------------|---------------|---|---|----------------------|----------------------|
| | | | LED | Power rating ≤200 kW | Power rating >200 kW |
| 1 | ISO 10816-7 | Category 1 - critical | Green | ≤ 4.0 | ≤ 5.0 |
| | | | Yellow | Between 4.0 and 6.6 | Between 5.0 and 7.6 |
| | | | Red | > 6.6 | > 7.6 |
| 2 | ISO 10816-7 | Category 2 - general | Green | ≤ 5.1 | ≤ 6.1 |
| | | | Yellow | Between 5.1 and 8.5 | Between 6.1 and 9.5 |
| | | | Red | > 8.5 | > 9.5 |
| 3 | ANSI/HI 9.6.4 | End suction, vertical inline, split case, and horizontal multistage | Green | ≤ 4.9 | ≤ 6.2 |
| | | | Red | > 4.9 | > 6.2 |
| 4 | ANSI/HI 9.6.4 | Vertical turbine and vertical multistage | Green | ≤ 4.3 | ≤ 5.6 |
| | | | Red | > 4.3 | > 5.6 |
| 5 | User Defined | N/A | Green | User Defined | |
| | | | Yellow | | |
| | | | Red | | |

6.11 LED Status on optimize sensor

| LED Status | Description |
|-----------------|--|
| Blinking Green | Shows that the asset health is good. |
| | Shows that the asset temperature is normal. |
| | Shows that the asset vibration is normal. |
| | Shows that the asset battery level is normal. |
| Blinking Yellow | If the optimize sensor has not yet been set up, the LED blinks yellow until the sensor is put into configuration mode. |
| | Shows that the asset health has deteriorated. |
| | Shows that the asset vibration has increased to warning level. |

| LED Status | Description |
|---------------------|--|
| Blinking Red | Shows that the asset health has become critical. |
| | Shows that the asset vibration has increased to critical level. |
| | Shows that the battery level is low. |
| | Shows that the asset temperature is more than the recommended limit. |
| Blinking Pink | Shows that the configuration mode is active. |
| Blinking Blue | Shows that the mobile phone is connected to the sensor. |
| Blinking Light Blue | Shows that the pressure sensor is connected to the optimize sensor. |
| Blinks White Once | Shows that the sensor is awake from the sleep mode. |
| | Indicates that the mobile phone has disconnected from the sensor. |


6.12 Add a wireless pressure sensor to the system

6.12.1 Prerequisites

Before installation of a pressure sensor check that the standard optimize sensor device is:

- Firmware must be version 2.0.2 or later.
- Configured successfully
- Collecting data according to the sensor configuration

6.12.2 Add the pressure sensor

1. From the optimize mobile application **Asset health** (Dashboard) page, tap the  icon.
2. On the **Add a sensor** page, select one of the following options:

| Entry | Action |
|--------------|--|
| QR code | Use the mobile phone camera to scan the QR code on the sensor. |
| Manual entry | Type the nine-digit serial number The serial number is located below the QR code . |

3. Tap **Enter**.
4. Select operating mode from the drop-down menu in the app.
5. If Differential Pressure mode is selected, scan the QR code or type the S/N manually of the second pressure sensor.
6. Put optimize sensor in configuration mode: Place the magnet supplied with the sensor over the Bluetooth® icon until the LED blinks pink; and then scan QR code or type S/N manually of optimize device. See [Set up the configuration mode](#) on page 15.
7. Click the Save button and wait until the mobile application returns to the dashboard. optimize sensors must be less than 30 m (100 ft) from pressure sensor to pair.
8. The optimize sensor blinks light blue while communicating with the pressure sensor.

6.12.3 Remove the pressure sensor

1. From the optimize mobile app dashboard, select the optimize sensor that is paired to the wireless pressure sensor.
2. Go inside the part which optimize sensor placed on.
3. On top right corner, select three dots.
4. Select Asset Setting from the opened menu.

5. Click on part which optimize device placed on from bottom Sensors Bar.
6. Select Remove Pressure Sensor.
7. The optimize mobile app will show the serial numbers of respective pressure sensors on each selection.
8. Put optimize sensor in configuration mode: Place the magnet supplied with the sensor over the Bluetooth® icon until the LED blinks pink; See [Set up the configuration mode](#) on page 15.
9. Press "Remove" button from the bottom of this page.
10. Mobile Application asks for confirmation to remove the pressure sensor.
11. Press "OK" to pop up warning.
12. Wait until the optimize mobile application shows "Successfully disconnected pressure sensor".
13. Press OK and wait until the application returns to the dashboard screen.

6.13 optimize Sensor firmware updates

When a firmware update is available, a notification will pop up on the dashboard of the optimize application.

To update the firmware, follow these steps:

1. Open the application dashboard and click on "Sensor update."
2. Set a selected optimize sensor to configuration mode and press on "update" for the corresponding sensor on the application.
3. Updates will begin; the application will display progress and notify when the update is complete.

Note: Ensure that the application is not closed or interrupted in the process.

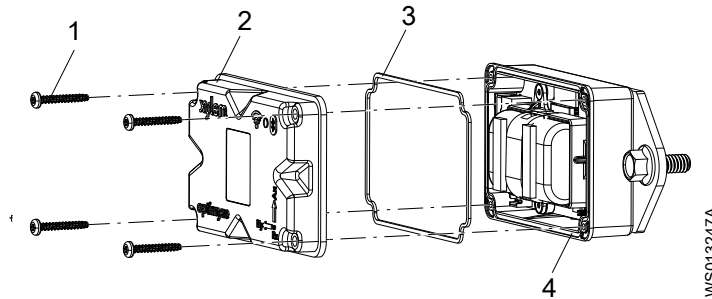
4. After completion, to view the updated Firmware version, go to Asset Setting and select sensor. Firmware version will be available under the "Details" section.

7 Maintenance

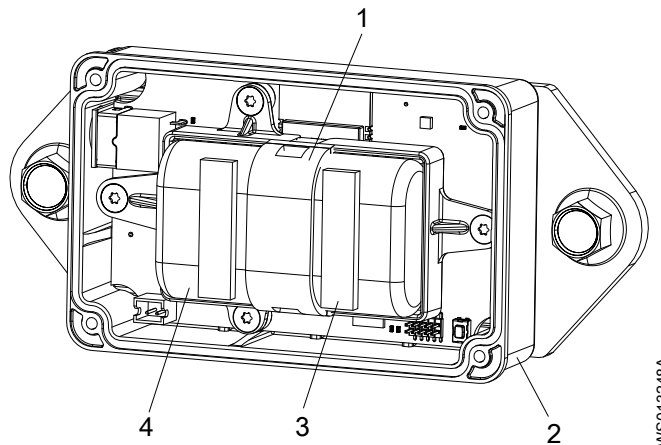
7.1 Replace the battery

7.1.1 Remove the battery

1. Use the supplied T10 screw driver to remove the screws from the casing.



1. Screw
 2. Upper cover
 3. Gasket
 4. Gasket groove
2. Remove the upper cover.
 3. Pinch the white connector tips. Carefully remove the battery leads. Damage to the printed circuit board (PCB) must be avoided.
 4. Carefully remove the battery clip by using a small flat head screwdriver.



1. Battery clip
 2. Lower cover
 3. Adhesive foam strip
 4. Batteries
5. Remove the batteries.
 6. Dispose the batteries in accordance with the local regulations. Batteries must not be reused.
 7. Remove the gasket from the groove of lower casing.
 8. Dispose the old gasket. Gasket must not be reused.

7.1.2 Clean the gasket groove

1. Use a small cotton bud and rubbing alcohol to clean the gasket groove in the lower cover.
2. Repeat this procedure for the upper cover.

7.1.3 Install the battery

1. Install the batteries into the battery holder.
The positive terminals of the batteries must face the power connectors on the PCB.
The negative terminals of the batteries must face the 5 V power connector located opposite of the battery connection pins.
2. Attach the battery clip on the batteries.
3. Check that the battery clip engages correctly.
4. Attach the supplied adhesive foam strips on the top of both the batteries.
Distance must be 0.5 cm (1/4 in) from the end of each battery.
5. Plug the white connectors of batteries on the PCB.

7.1.4 Install the cover

1. Install the new gasket in the gasket groove of the lower cover.
2. Carefully install the upper cover on the lower cover.
The outer rim of the cover must surround the lip of the lower cover.
The Xylem logo must align with the external power supply connector.
3. Use the T10 screw driver to install the screws on the cover.
4. Tighten the screws diagonally opposite of one another to prevent rolling or pinching of the gasket.
5. Use a torque wrench to tighten the screws of the cover.
The torque must be 0.88 Nm (7.8 lbf.in).

7.2 Replace the pressure sensor battery

To replace the optimize pressure sensor battery, follow these steps:

1. Remove the pressure sensor cap by turning it counterclockwise.



2. Put a small screwdriver blade between plug and socket and pry up to remove plug from socket. The plug only installs one way. Remove the battery.



3. Wait a minimum of 90 seconds before inserting a new battery. The transducer must reset before connecting a new battery.
4. Replace the cap turning it clockwise until it stops. The arrow on the cap should align with an arrow on the sensor body.

8 Troubleshooting

8.1 Symptoms and remedies

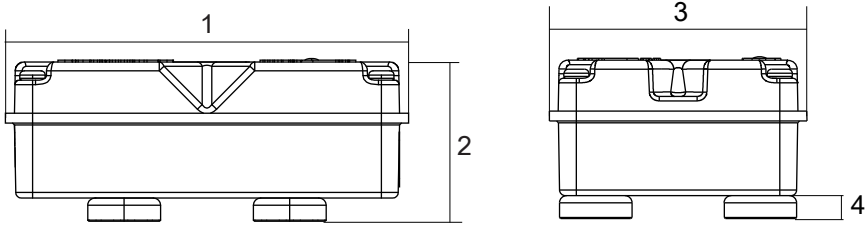
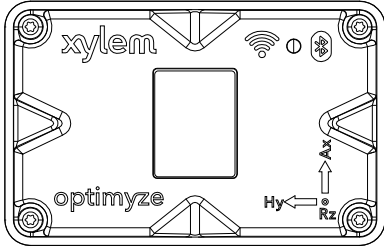
| Symptom | Cause | Remedy |
|--|--|--|
| The LED is off. | The sensor is in sleep mode. | <ol style="list-style-type: none"> 1. Activate the sensor. For more information, see Activate the sensor on page 14. 2. Battery of the sensor is depleted. 3. If necessary, replace the battery. |
| The optimize application icon is not visible on the mobile device. | – | Check the application page in mobile device for the optimize application icon. |
| No information is displayed on the Scan QR code screen. | The camera of mobile device is turned off in privacy. | Turn on the camera in privacy for mobile device. |
| | The Bluetooth wireless technology is turned off in settings and privacy for mobile device. | Turn on the Bluetooth wireless technology. |
| Incorrect serial number is entered. | The Valid serial number is 9 digits long and starts with 3 message is shown. | Check that the serial number is correct. |
| The Enter button is not seen on the bottom of the screen, after the serial number is entered. | The soft keyboard on the phone screen hides the Enter button at the bottom of the screen. | Tap Done button or the background to close the soft keyboard. |
| Cannot find the device, try again. message is shown. | <p>The sensor is in sleep mode.</p> <p>The configuration mode is off.</p> <p>The incorrect serial number is entered.</p> | <ol style="list-style-type: none"> 1. Activate the sensor. For more information, see Activate the sensor on page 14. 2. Set up the sensor to configuration mode. For more information, see Set up the configuration mode on page 15. 3. Check that the QR code or the serial number is correct. |
| Device found, turn on configuration mode and try again message is shown. | <p>The configuration mode is off.</p> <p>The configuration mode is on and does not connect with mobile device.</p> | <ol style="list-style-type: none"> 1. Set up the sensor to configuration mode. For more information, see Set up the configuration mode on page 15. 2. Check the Bluetooth wireless technology compatibility. The Bluetooth wireless technology software version must be 5.0. 3. Connect the mobile device to sensor. For more information, see Connect a mobile phone to the sensor on page 15. |

| Symptom | Cause | Remedy |
|---|---|---|
| The LED does not change from blink white to blink pink, after the magnet is kept near the Bluetooth® icon. | - | <ol style="list-style-type: none"> 1. Move the magnet away from the sensor for a short duration and then try again. 2. Hold the magnet along the side wall of the sensor near the Bluetooth® icon. |
| The sensor does not turn on after the magnet is kept near the Bluetooth® icon. | | |
| Pressure sensor is not connecting with optimize device or optimize app is not able to find the pressure sensor. | | <ol style="list-style-type: none"> 1. Move the pressure sensor closer. 2. Replace the battery. |
| Sensor firmware update failing | <ul style="list-style-type: none"> • The sensor is not in configuration mode. • The mobile device may have moved out of connection range or been interrupted during update. | <ol style="list-style-type: none"> 1. Set the optimize sensor to configuration mode before selecting "Update" on application. 2. Ensure mobile device stays within connection range and application is open until update is complete. |

9 Technical Specification

9.1 Dimensions

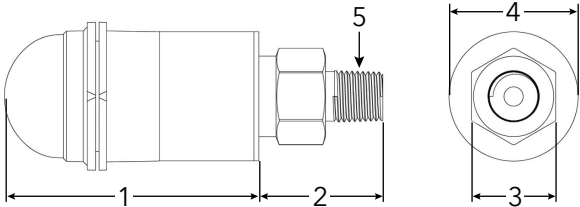
9.1.1 optimize sensor dimensions



WS013249A

| Item | Dimension |
|------|-------------------|
| 1 | 88.6 mm (3.49 in) |
| 2 | 35.4 mm (1.39 in) |
| 3 | 56.9 mm (2.24 in) |
| 4 | 5.1 mm (0.20 in) |

9.1.2 optimize pressure sensor dimensions



| Item | Dimension mm (In) |
|------|-------------------|
| 1 | 67.05 (2.64) |
| 2 | 32.76 (1.29) |
| 3 | 7/8 HEX |
| 4 | ø34.03 (1.34) |
| 5 | 1/4" NPT Male |

Dimensions are for reference only.

9.2 Approvals

| Optimize Sensor | Optimize Pressure sensor |
|--|--|
| <ul style="list-style-type: none"> • CE • FCC and IC • UL and cUL | <ul style="list-style-type: none"> • CE • FCC and IC |

9.3 Environmental requirements

optimize sensor

| Feature | Value |
|-----------------------|---|
| Operating location | Indoor use or outdoor use |
| Operating environment | Non-hazardous, non-corrosive |
| Operating temperature | -20°C to +50°C (-4°F to +122°F) |
| Storage temperature | -25°C to +65°C (-13°F to +149°F) |
| Operating humidity | 5% to 95% relative humidity, non-condensing |
| Protection rating | NEMA4 / IP56 |

optimize pressure sensor

| Feature | Value |
|-------------------------|---|
| Operating location | Indoor use or outdoor use |
| Compensated temperature | -10°C to +85°C (+14°F to +182°F) |
| Operating temperature | -40°C to +85°C (-40°F to +182°F) |
| Storage temperature | -40°C to +125°C (-49°F to +257°F) without battery |
| Total Error Band (TEB) | 3% Full Scale (FS) |
| Long term drift | 0.2% FS/year (non-cumulative) |
| Shock | 50g, 11 ms, 1/2 sine |
| Vibration | 10g, peak, 20 to 2400 Hz |
| EMI/RFI Protection | Yes |
| Ingress Rating | IP-67 |

9.4 Surface temperature measurement

| Feature | Value |
|--|---|
| Measurement range | -20°C to +135°C (-4°F to +275°F) |
| Measurement method | Non-contact infrared temperature sensor |
| Minor gradient accuracy (0°C to 25°C gradient) | +/-1°C |
| Moderate gradient accuracy (25°C to 50°C gradient) | +/-2°C |
| Large gradient accuracy (50°C to 100°C gradient) | +/-4°C |

9.5 Vibration measurement

| Feature | Description |
|---------------------------|--------------------|
| Frequency range | 5 Hz to 1,100 Hz |
| Measurement method | Independent 3-axis |
| Primary output (per axis) | Single value RMS |

| Feature | Description |
|------------------------------------|------------------|
| Other outputs | Kurtosis and FFT |
| Vibration limit (max acceleration) | 16 g |
| Threshold standard (Global) | ISO 10816-7 |
| Threshold standard (North America) | ANSI/HI 9.6.4 |

9.6 Power

optimize sensor

| Feature | Description |
|--|---------------------------------|
| Batteries (replaceable) | (2) 3.6 V AA, 2400 mAh, Lithium |
| Battery life ³ | 3 to 5 years |
| Default sampling rate | 1 sample per 30 minutes |
| Available sampling rates (one sample per unit of time) | 10 seconds to 12 hours |

optimize pressure sensor

| Feature | Description |
|--------------|--|
| Battery | 3.6 V Proprietary replacement battery |
| Battery life | 24 months, typical. Battery life is affected by high and low temperature |

9.7 Wireless communication

optimize sensor

| Feature | Description |
|---|---|
| Network type | Bluetooth® Low Energy 5.01 2.4 GHz ISM band RF 3.29 mW (5.17 dBm) |
| Connection range (without interference) | 30 meters (100 feet) |

optimize pressure sensor

| Feature | Description |
|---|--|
| Network type | Bluetooth® Low Energy 4.2 2.4 GHz ISM band RF 3.78 mW (5.78 dBm) |
| Connection range (without interference) | 30 meters (100 feet) |

9.8 Physical properties

optimize sensor

| Feature | Description |
|----------------------------|---------------------------------|
| Weight | 145 g (0.32 lb) |
| Status | LED |
| Mounting method (standard) | Magnetic (16 mm potted magnets) |

³ using default sampling rate at 25°C, one connection for each day

| Feature | Description |
|----------------------------|--------------------------|
| Mounting method (optional) | Drill and tap with plate |

9.9 Part numbers

| Part | Part number |
|---|-------------|
| optimize (standard sensor) | P2007024 |
| optimize battery replacement kit | P2007030 |
| optimize optional flat plate mounting kit | P2007031 |
| optimize pressure sensor 0 – 100 psi | P2004731 |
| optimize pressure sensor 0 – 250 psi | P2004753 |
| optimize pressure sensor 0 – 500 psi | P2004754 |
| optimize pressure sensor battery | P2004732 |

10 Product Warranty

10 Commercial warranty

Warranty. For goods sold to commercial buyers, Seller warrants the goods sold to Buyer hereunder (with the exception of membranes, seals, gaskets, elastomer materials, coatings and other "wear parts" or consumables all of which are not warranted except as otherwise provided in the quotation or sales form) will be (i) be built in accordance with the specifications referred to in the quotation or sales form, if such specifications are expressly made a part of this Agreement, and (ii) free from defects in material and workmanship for a period of twelve (12) months from the date of installation or eighteen (18) months from the date of shipment (which date of shipment shall not be greater than thirty (30) days sixty (60) days after receipt of notice that the goods are ready to ship), whichever shall occur first, unless a longer period is specified in the product documentation (the "Warranty").

Except as otherwise required by law, Seller shall, at its option and at no cost to Buyer, either repair or replace any product which fails to conform with the Warranty provided Buyer gives written notice to Seller of any defects in material or workmanship within ten (10) days of the date when any defects or non-conformance are first manifest. Under either repair or replacement option, Seller shall not be obligated to remove or pay for the removal of the defective product or install or pay for the installation of the replaced or repaired product and Buyer shall be responsible for all other costs, including, but not limited to, service costs, shipping fees and expenses. Seller shall have sole discretion as to the method or means of repair or replacement. Buyer's failure to comply with Seller's repair or replacement directions shall terminate Seller's obligations under this Warranty and render the Warranty void. Any parts repaired or replaced under the Warranty are warranted only for the balance of the warranty period on the parts that were repaired or replaced. Seller shall have no warranty obligations to Buyer with respect to any product or parts of a product that have been: (a) repaired by third parties other than Seller or without Seller's written approval; (b) subject to misuse, misapplication, neglect, alteration, accident, or physical damage; (c) used in a manner contrary to Seller's instructions for installation, operation and maintenance; (d) damaged from ordinary wear and tear, corrosion, or chemical attack; (e) damaged due to abnormal conditions, vibration, failure to properly prime, or operation without flow; (f) damaged due to a defective power supply or improper electrical protection; or (g) damaged resulting from the use of accessory equipment not sold or approved by Seller. In any case of products not manufactured by Seller, there is no warranty from Seller; however, Seller will extend to Buyer any warranty received from Seller's supplier of such products.

THE FOREGOING WARRANTY IS EXCLUSIVE AND IN LIEU OF ANY AND ALL OTHER EXPRESS OR IMPLIED WARRANTIES, GUARANTEES, CONDITIONS OR TERMS OF WHATEVER NATURE RELATING TO THE GOODS PROVIDED HEREUNDER, INCLUDING WITHOUT LIMITATION ANY IMPLIED WARRANTIES OF MERCHANTABILITY AND FITNESS FOR A PARTICULAR PURPOSE, WHICH ARE HEREBY EXPRESSLY DISCLAIMED AND EXCLUDED. EXCEPT AS OTHERWISE REQUIRED BY LAW, BUYER'S EXCLUSIVE REMEDY AND SELLER'S AGGREGATE LIABILITY FOR BREACH OF ANY OF THE FOREGOING WARRANTIES ARE LIMITED TO REPAIRING OR REPLACING THE PRODUCT AND SHALL IN ALL CASES BE LIMITED TO THE AMOUNT PAID BY THE BUYER FOR THE DEFECTIVE PRODUCT. IN NO EVENT SHALL SELLER BE LIABLE FOR ANY OTHER FORM OF DAMAGES, WHETHER DIRECT, INDIRECT, LIQUIDATED, INCIDENTAL, CONSEQUENTIAL, PUNITIVE, EXEMPLARY OR SPECIAL DAMAGES, INCLUDING BUT NOT LIMITED TO LOSS OF PROFIT, LOSS OF ANTICIPATED SAVINGS OR REVENUE, LOSS OF INCOME, LOSS OF BUSINESS, LOSS OF PRODUCTION, LOSS OF OPPORTUNITY OR LOSS OF REPUTATION.

11 Cybersecurity

Defending against cybersecurity threats requires partnership and shared responsibility. Xylem's responsibility is to build products that include security features by design. The customer has a responsibility to understand the risks inherent in the processes and take steps to operate and maintain their solutions securely. This section gives an overview of existing security features and guidance that will help securely operate Optimize.

11.1 Xylem Product Cybersecurity

Xylem performs appropriate due care in building security into products and solutions from design through end of life. For more information on Xylem cybersecurity practices or to contact the cybersecurity team please visit xylem.com/security.

- Based on the level of risk, product security experts perform **threat modeling** to recommend a **testable controls baseline** that impacts the requirements and design.
- During all product development and implementation, the code is scanned for flaws with **static analysis** tools to identify common security errors and the **product components are analyzed** to understand dependencies and identify and fix flaws in third party components.
- Xylem applies **security validation** once the product is materially built through a series of automated and manual tests to validate that the security protections built into each product perform as expected. The results from this testing are used to improve the security protections and the quality of the software in the product.
- Xylem maintains relationships with customers, integrators, and the cybersecurity research community and the **Product Security Incident Response Team (PSIRT)** coordinates the collection, analysis, remediation, and responsible disclosure of vulnerability and remediation information to keep products secure.
- Xylem monitors as components approach end-of-support and end-of-life and proactively communicate with customers regarding **product lifecycle** implications.
- Product security is **governed through a three lines of defense** model, in which product engineers are the first-line building security features in to their development backlogs and scheduling testing, the product security leaders and engineers provide credible challenges and shared resources to enhance native abilities, and the audit team monitors fulfillment of security development processes.

11.2 Optimize Security Features

Xylem prioritizes the availability, integrity, and confidentiality in all products.

| Security consideration | Configuration |
|------------------------|--|
| Physical | <ul style="list-style-type: none"> • Device is hardened with upgrades available via the mobile app • Firmware is encrypted and digitally signed and verified at runtime • Bootloader integrity is maintained by signing the binaries at the source and then verifying the same at the device. • Authenticated and authorized Xylem developer is allowed to trigger the update to devices; end user needs to approve it from the mobile app. • Protective coating is applied to the board to avoid physical tampering. • Automatic reset of the device in the state of fault triggers by implementing watchdog timers. • Strict BLE pairing with only authorized devices is implemented. |

| Security consideration | Configuration |
|------------------------|--|
| Interfaces | <ul style="list-style-type: none"> Enabled interfaces are limited (only BLE enabled). WiFi is disabled by default. Hardware-based debug is restricted (Physical connectors are removed) |
| Network | <ul style="list-style-type: none"> Firewall-based access is enforced Data flow to headend is encrypted via TLS 1.2 with strong ciphers BLE 5.0 incorporated. Cloud back-end is continuously monitored by Xylem product security operations center (PSOC) |
| Mobile Application | <ul style="list-style-type: none"> Mobile application authentication is implemented Application is hardened with upgrades available on App Store Sensitive data is not stored in mobile application storage Security-relevant events are logged |

11.3 Optimize Security Recommendations for End-User

While such measures are desirable and are strictly implemented by Xylem during the development process and have been rigorously tested by the security engineers, it is also recommended that customers apply additional safeguards consistent with their cybersecurity policy.

| Safeguard | Rationale | References |
|---|---|--|
| <ul style="list-style-type: none"> Ensure access to customer-managed assets in the Customer's Operating Environment is limited. Include physical isolation to protect the environment and equipment therein. Ensure strict control over physical access in and out of the customer's facility. Report any security-related incidents associated with Optimize device to Xylem. These might include unexpected operations, confirmed tampering, or theft of the device. <p>(xylem.com/security)</p> | Supports the ability to further limit exposure (or damage) as associated with network-based threats and physical threats. | ATT&CK for ICS: M0801 NIST SP 800-53 Rev. 5: AC-3 ISA/IEC 62443-3-3:2013: SR 2.1 ISA/IEC 62443-4-2:2019: CR 2.1 |
| Role Based Access Control (RBAC) is recommended: User registration is performed by the user via app. Recommend that each account is tied to an individual. | Ensures low level accounts do not perform privileged actions. | ATT&CK for ICS: M0801 NIST SP 800-53 Rev. 5: AC-3 (7) |
| Ensure Magnet Key is removed after putting the device in Configuration Mode so that the device does not re-enter Configuration Mode unexpectedly and enable alternative access to your data. | Provides additional checks and ensures no unexpected connections from Bluetooth devices. | ISA/IEC 62443-4-2:2019: CR.4.1 NIST SP 800-53 Rev. 5: AC-18 ISA/IEC 62443-4-2:2019: NDR.1.6 |

| Safeguard | Rationale | References |
|---|---|---|
| Ensure Bluetooth signal cannot be received outside the organization-controlled boundaries by employing emission security and purposefully positioning the device. | Reduces the likelihood of capturing or intercepting wireless signals. | ATT&CK for ICS: M0806 NIST SP 800-53 Rev. 5: AC-18 NIST SP 800-53 Rev. 5: SC-40 |
| Implement specific inventory, logging and monitoring for hardware at customer premises. | Supports the ability to tell who did what and when (e.g. active threat detection and / or forensics). | ATT&CK for ICS: M0947 NIST SP 800-53 Rev. 5: SM-8 ISA/IEC 62443-3-3:2013: SR 1.11, SR 2.8, SR 3.4 ISA/IEC 62443-4-2:2019: CR 3.4 |
| Maintain updated firmware and software: Over the air (OTA) firmware updates for the device are available on the Optimize app as a "Sensor update" pop up option on the screen. Mobile App updates are available on the play store and all the customers will be notified about the updates available. | Mitigates exploitation risks and ensures security patching | ATT&CK for ICS ID: M0951 NIST SP 800-53 Rev. 5: MA-3(6) ISA/IEC 62443-3-3:2013: SR 3.1.3, SR 7.1 ISA/IEC 62443-4-2:2019: CR 3.10 |
| Ensure cybersecurity policies, awareness, and training to the operators, administrators and other personnel. | Prevents Social Engineering attacks and promotes awareness related to cybersecurity. | NIST SP 800-53 Rev. 5: AT |

For additional information see references:

1. ATT&CK for ICS available online: https://collaborate.mitre.org/attackics/index.php/Technique_Matrix
2. NIST SP 800-53 Rev 5 available online: <https://nvlpubs.nist.gov/nistpubs/SpecialPublications/NIST.SP.800-53r5.pdf>
3. ISA/IEC 62443 standards available for purchase from ISA, IEC, or ANSI.

12 Certifications

12.1 optimize device: For US and Canada only

12.1.1 FCC/IC statement

This device complies with Part 15 of the FCC Rules. Operation is subject to the following two conditions:

1. This device may not cause harmful interference.
2. This device must accept any interference received, including interference that may cause undesired operation.

12.1.2 CAN ICES-3 (A)/NMB-3(A)

Any changes or modifications not expressly approved by Xylem Inc. Could void the user's authority to operate this equipment.

NOTICE:

This equipment has been tested and found to comply with the limits for a Class A digital device, pursuant to part 15 of the FCC Rules. These limits are designed to provide reasonable protection against harmful interference when the equipment is operated in a commercial environment. This equipment generates, uses, and can radiate radio frequency energy and, if not installed and used in accordance with the instruction manual, may cause harmful interference to radio communications. Operation of this equipment in a residential area is likely to cause harmful interference in which case the user will be required to correct the interference at their expense.

12.1.3 FCC / IC RF radiation exposure statement

The device shall be used in such a manner that the potential for human contact normal operation is minimized. This equipment complies with FCC/IC RSS-102 radiation exposure limits for an uncontrolled environment. This equipment should be installed and operated with a minimum distance of 20 cm between the radiator and your body. This device and its antenna(s) must not be co-located or operating in conjunction with any other antenna or transmitter.

12.1.4 UL and cUL listed (E516095)

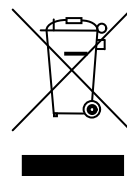
This product is listed by UL and cUL. Representative samples of this product have been evaluated by UL and meet applicable safety standards.

12.2 optimize device: For EU countries

12.2.1 RF radiation exposure statement

The device shall be used in such a manner that the potential for human contact normal operation is minimized. This equipment complies with EN 62311:2008 and basic restrictions listed in 1999/519/EC. This equipment should be installed and operated with a minimum distance of 20 cm between the radiator and your body. This device and its antenna(s) must not be co-located or operating in conjunction with any other antenna or transmitter.

12.2.2 WEEE 2012/19/EU Notice



W5S009873B

INFORMATION FOR USERS pursuant to art. 14 of Directive 2012/19 / EU of the European Parliament and of the Council of July 4, 2012 on waste electrical and electronic equipment (WEEE). The crossed-out container symbol that appears on the appliance or on its packaging indicates that the product, at the end of its useful life, must be collected separately and must not be disposed of together with other mixed municipal waste. Appropriate selective collection that then allows the device that is no longer used to be subjected to recycling, treatment and disposal compatible with the environment, helps to avoid possible negative effects on the environment and health and favors reuse and / or recycling of the materials of which the device is composed.

The selective collection of this device at the end of its life is organized and managed by the producer. Therefore, if the user wants to eliminate this device, he or she can contact the producer and follow the system that he uses to allow the selective collection of the device at the end of its life, or independently select an authorized chain for its management.

12.3 optimize pressure sensor: For US and Canada only

12.3.1 FCC/IC statement

This device complies with Part 15 of the FCC Rules. Operation is subject to the following two conditions:

1. This device may not cause harmful interference.
2. This device must accept any interference received, including interference that may cause undesired operation.

13 Declaration of Conformity

13.1 EU Declaration of Conformity

1. (RE-D) Radio equipment: optimize
(RoHS) Unique identification of the EEE: optimize
2. Name and address of the manufacturer:
Fluid Handling LLC, 8200 Austin Avenue, Morton Grove, IL 60053, USA
Name and address of the authorized representative⁴:
Xylem Service Italia S.r.l., Via Vittorio Lombardi 14, 36075 Montecchio Maggiore VI, Italy
3. This declaration of conformity is issued under the sole responsibility of the manufacturer.
4. Object of the declaration: monitoring device
5. The object of the declaration described above is in conformity with the relevant Union harmonization legislation:
 - directive 2014/53/EU of 16 April 2014 (radio equipment) and subsequent amendments.
 - directive 2011/65/EU of 8 June 2011 (restriction of the use of certain hazardous substances in electrical and electronic equipment) and subsequent amendments.
6. References to the relevant harmonized standards used or references to the other technical specifications, in relation to which conformity is declared:
 - EN 61010-1:2010+A1:2019, EN 62311:2008, EN 61000-6-2:2005, EN 61000-6-3:2007+A1:2011, EN 61326-1:2013, ETSI EN 301 489-1 V1.9.2 (2011-09) & V2.2.3 (2019-11), ETSI EN 301 489-17 V3.1.1 (2017-02), ETSI EN 300 328 V2.2.2 (2019-07).
 - EN 50581:2012.
7. Notified body: -
8. Accessories and components covered by the EU declaration of conformity: flat plate mounting kit (on request).
9. Additional information: -

Signed for and on behalf of:
Montecchio Maggiore, 14/01/2021
Amedeo Valente
(Director of Engineering and R&D)
rev.00

Fluid Handling LLC



⁴ as defined by the applicable product directives.

Xylem |'zīləm|

- 1) The tissue in plants that brings water upward from the roots;
- 2) a leading global water technology company.

We're a global team unified in a common purpose: creating advanced technology solutions to the world's water challenges. Developing new technologies that will improve the way water is used, conserved, and re-used in the future is central to our work. Our products and services move, treat, analyze, monitor and return water to the environment, in public utility, industrial, residential and commercial building services settings. Xylem also provides a leading portfolio of smart metering, network technologies and advanced analytics solutions for water, electric and gas utilities. In more than 150 countries, we have strong, long-standing relationships with customers who know us for our powerful combination of leading product brands and applications expertise with a strong focus on developing comprehensive, sustainable solutions.

For more information on how Xylem can help you, go to www.xylem.com



Xylem Inc.
8200 N. Austin Avenue
Morton Grove, IL 60053
Tel: (847) 966-3700
Fax: (847) 965-8379
www.xylem.com/bellgossett

Visit our Web site for the latest version of this document and more information

The original instruction is in English. All non-English instructions are translations of the original instruction.

© 2023 Xylem Inc.

Xylem is a trademark of Xylem Inc. or one of its subsidiaries. All other trademarks or registered trademarks are property of their respective owners.