



Tailor-made to your plant: IQ SENSOR NET

MODULAR SYSTEM 2020, EASILY EXPANDABLE IN THE FUTURE



a xylem brand

A Flexible System – Reliable Results

The IQ SENSOR NET is of modular design and grows with your demands.

- Large, color display with user-friendly buttons in all weather conditions
- Feature enhancements by addition of specific modules
- Low installation costs by stack-mounting without cable

Application areas and system concept

The IQ SENSOR NET is a network for analytical measurements. It is in worldwide operation since 2001, constantly evolving to meet customer needs. It is used for inlet and outlet monitoring, as well as for controlling the activated sludge process.

Due to its modular design, the system can be expanded any time by adding further modules and sensors in any order.



IQ SENSOR NET

Further advantages

- 20 sensors connectable
- Automatic sensor recognition
- Centralized power supply for entire system
- IP66 and IP67 protection (depending on module)
- Full remote access without any extra costs with IQ WEB CONNECT
- Free-of-charge software updates
- Internal data logger
- USB interface for data storage and updates by default
- Up to 3 km cable length permitted
- At least two IQ SENSOR NET connections per module for sensors or modules
- Feature enhancements by addition of specific modules
- Low installation costs by stack mounting without cable



The Construction Kit to Suit your Needs

The basic equipment

The Terminal with large display, user-friendly buttons working in all weather conditions and the power supply module



MIQ/TC 2020 3G
connectable to any module



MIQ/PS or MIQ/24V
For wide range or 24V (AC and DC) power supply

The modules

Expand the functions of your system by adding specific modules. Some examples:

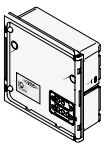

MIQ/CR3
With 3 current outputs and 3 relays

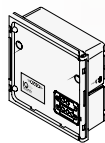

MIQ/C6
With 6 current outputs

MIQ/R6
With 6 relays

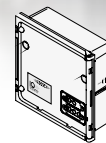

MIQ/IC2
With 2 current inputs to connect any third party sensor (e.g. level)

The sensors and parameters

All common parameters from inlet to outlet. The sensors can be connected with a universal cable to any module.



MIQ/JB

With 4 sensor connections

MIQ/JBR

With 4 sensor connections and signal amplifier for longer cable lengths



MIQ/CHV Plus

For automatic pressured air cleaning of any sensor

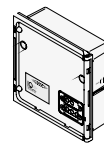

MIQ/WL PS

For radio transmission (e.g. at moving scraper bridges)

The Installation

Connect the modules via cable or by cable-free stack mounting, and connect sensors at any module.

- Module connection via SNCIQ cable
- Easy and cable-free stack-mounting thanks to universal module design
- Universal cable for sensors (SACIQ) and modules (SNCIQ)

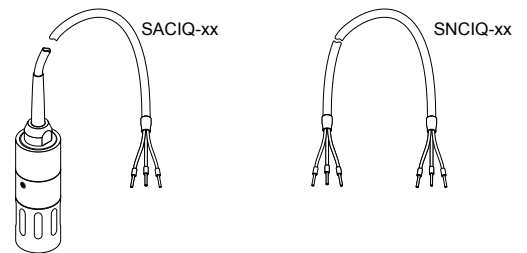
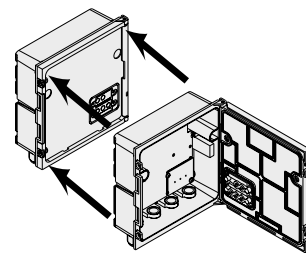
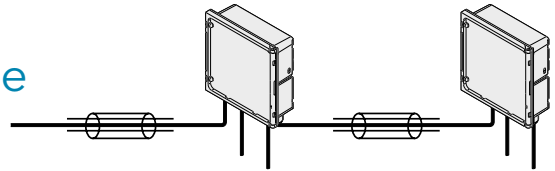

Example 1

System 2020 3G

Configuration example	Order No.
MIQ/TC 2020 3G-CR3	470 022
SACIQ-7,0	480 042
IQ Sensors	user selected

MIQ/TC 2020 3G-CR3 Starter Set

consistig of:

- MIQ/TC 2020 3G (terminal/controller)
- MIQ/CR3 (3 x mA, 3 x relays)
- MIQ/PS (power supply)

additionally:

- 3 SACIQ (sensor connection cable)
- 3 IQ sensors

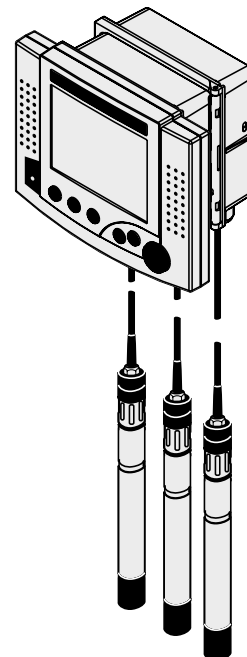

Multiparameter controller for up to 5 selectable sensors, with 3 current outputs and 3 relays

Example 2 System 2020 3G

Configuration example Order No.

MIQ/TC 2020 3G	470020
MIQ/PS	480004
MIQ/C6	480015
MIQ/JB	480008
Further modules connectable (user selected)	
SACIQ-7,0	480042
IQ sensors	user selected
SNCIQ	480046

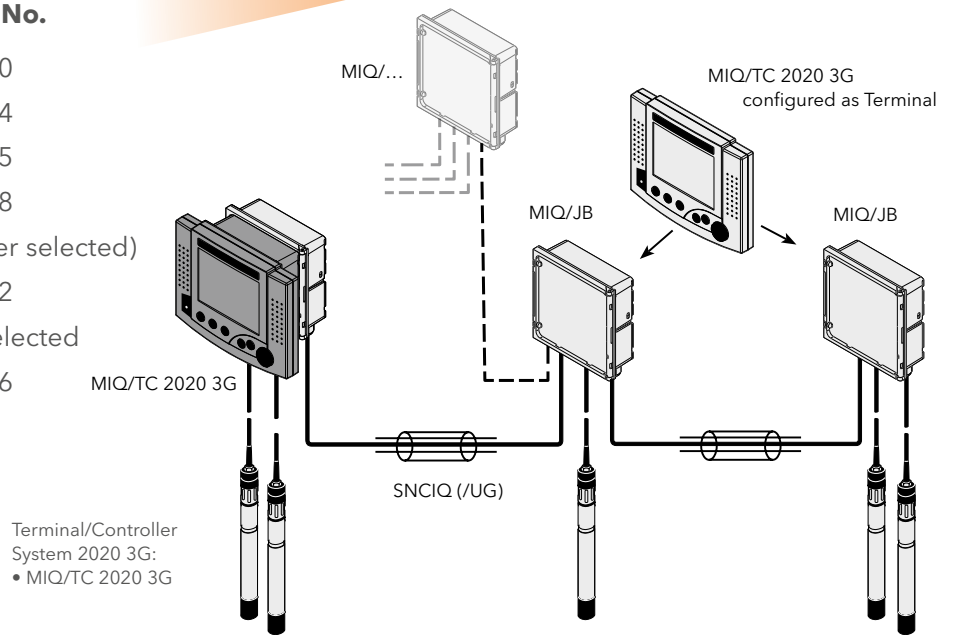

Branched network System 2020 3G for up to 20 freely selectable parameters. Example with 6 current outputs; measuring locations 2 and 3 are at a larger distance from the Terminal/Controller. Expandable with a portable Terminal MIQ/TC 2020 3G as an additional display for easy on-site calibration and redundant Controller function.

Example 3 System 2020 3G

Configuration example Order No.

MIQ/TC 2020 3G	470020
MIQ/PS	480004
MIQ/MC3	471020
MIQ/JB	480008
SACIQ-7,0	480042
IQ Sensors	user selected
SNCIQ	480046

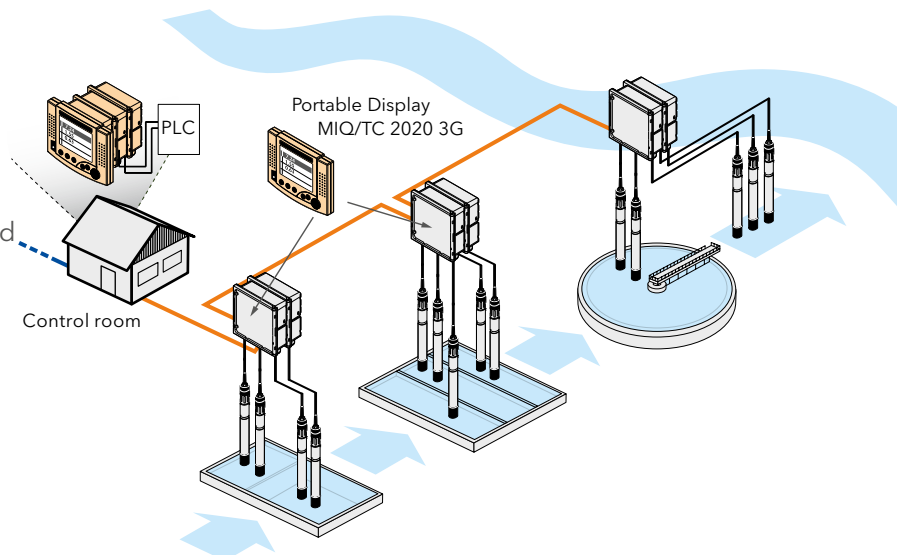

Certainly Flexible

Portable Terminal, data transfer to PLC by fieldbus, Controller backup function or operation from remote – stay future-proof and flexible with the IQ SENSOR NET.

- Portable Terminal with Controller backup function
- Digital interfaces and Controller backup function
- Free-of-charge remote access with IQ WEB CONNECT

Portable Terminal with Controller backup function

Use a fixed Terminal along with a portable one. Connect the portable terminal to any module and check the measured values right next to the sensors. In case of damage the portable terminal takes control of the system, thereby increasing the operational safety.

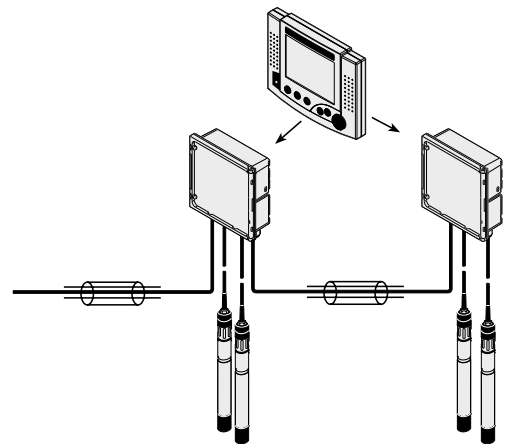

Digital interfaces and Controller backup function

To transfer the measured values to the PLC, analog outputs as well as digital fieldbuses are provided on the appropriate MIQ/MC3 controller module. Thus, the Terminal becomes portable and increases the operational safety, taking control of the system in case of damage.



Full remote access with IQ WEB CONNECT

Control your IQ SENSOR NET conveniently from a distance. The IQ WEB CONNECT allows data storage and settings at any time free of charge, without subscription, secured by password.

Just connect the IQ SENSOR NET to the internet or a local network via the integrated Ethernet interface.



Read – Monitor all measured values at a glance



Set – Apply all changes from a distance with convenient input via keyboard



Store – Store your data logger configuration and measured data and plot your own graphs.

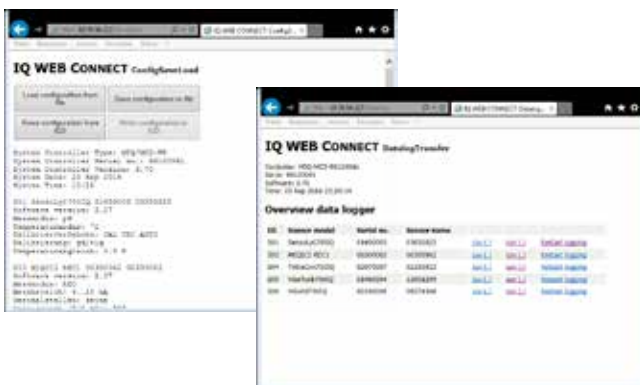

IQ WEB CONNECT on the Internet

Watch our video and see for yourself:

www.wtw.com/webconnect (or scan the QR code).

The Sensors

All IQ sensors are characterized by their robustness and durability. The universal sensor cable and the automatic recognition allow for an easy installation and commissioning. Further convincing are unique technical features, e.g. ultrasonic cleaning.

Optical, calibration-free oxygen sensor

- Precise measurements without false high readings by sloped membrane cap
- Long durability (3-5 years) and easy exchange of the sensor cap minimize maintenance
- No electrolyte, no flow required



Stable NH₄ and NO₃ sensors

- Stable measurements, compensable, no drift
- Robust electrodes can be replaced individually and cleaned easily
- Fast and easy matrix adjustment



Maintenance-free TSS and Turbidity sensors

- Integrated, automatic ultrasonic cleaning
- No wiper, no smearing
- Low maintenance, no spare parts, no maintenance contracts required



Reagent-free spectral COD, NO₃, NO₂ sensors

- Optical, reagent-free measurement (turbidity compensated)
- Integrated, automatic ultrasonic cleaning, no wiper
- Specific algorithms for different applications



Maintenance-free sludge level sensor

- Easy installation
- Minimum maintenance, no influence of air bubbles
- Reliable measurements, even with challenging applications



Technical data

Material	Polycarbonate with 20% glass fibre
Dimensions	Terminal: 8.3 x 6.7 x 1.6 in (W x H x D); (210 x 170 x 40 mm) Modules: 5.7 x 5.7 x 2.0 in (W x H x D); (144 x 144 x 52 mm)
Protection class	Modules: IP66 and IP67, respectively Sensors: IP68
Certificates	CE, cETL, ETL
Warranty	Modules and Terminals: 3 years Sensors: 2 years
Operational conditions	Operational temperature: -4 °F ... +131 °F; (-20 °C ... +55 °C) Storage temperature: -13 °F ... +149 °F; (-25 °C ... +65 °C)

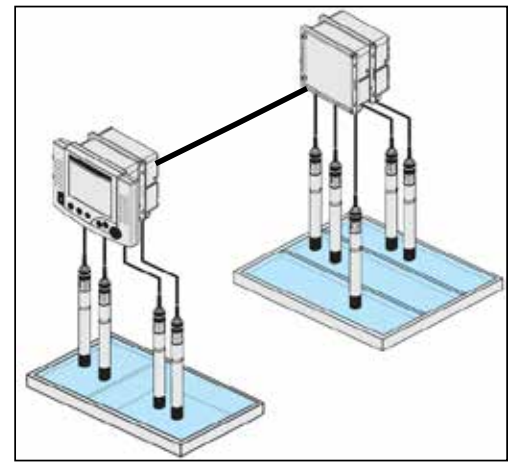

Ordering information

Model	Description	Order no.
MIQ/TC 2020 3G	Terminal/Controller for the IQ Sensor Net System 2020, portable Terminal with large color display, robust buttons and USB interface	470020
MIQ/TC 2020 3G-CR3	Ready-to-use starter set, consisting of Terminal (MIQ/TC 2020 3G), power supply module (MIQ/PS) and output module (MIQ/CR3)	470022
MIQ/TC 2020 3G-C6	Ready-to-use starter set, consisting of Terminal (MIQ/TC 2020 3G), power supply module (MIQ/PS) and output module (MIQ/C6)	470024
MIQ/TC 2020 3G-EF	Ready-to-use starter set, consisting of Terminal (MIQ/TC 2020 3G), power supply module (MIQ/PS) and Controller module (MIQ/MC3)	470026
SNCIQ ...	Connection cable, available in different lengths	480046 and 480068 ... 480072
SACIQ-...	Sensor cable, available in different lengths	480040 ... 480044
MIQ/PS	Wide range power supply module	480004
MIQ/24V	24V (AC and DC) power supply module	480006
MIQ/JB	Module with 4 sensor connections	480008
MIQ/JBR	Module with 4 sensor connections and signal amplifier for long cables	480010
MIQ/R6	Module with 6 relays	480013
MIQ/CR3	Module with 3 current outputs and 3 relays	480014
MIQ/C6	Module with 6 current outputs	480015
MIQ/IC2	Module with 2 inputs for connection of any third party sensor (e.g. level)	480016
MIQ/CHV PLUS	Module with automatic pressured air cleaning for any sensor	480018
MIQ/WL PS Set	Radio transmission module (e.g. for use at moving scraper bridges)	480025

What can Xylem do for you?

We're a global team unified in a common purpose: creating advanced technology solutions to the world's water challenges. Developing new technologies that will improve the way water is used, conserved, and re-used in the future is central to our work. Our products and services move, treat, analyze, monitor and return water to the environment, in public utility, industrial, residential and commercial building services, and agricultural settings. With its October 2016 acquisition of Sensus, Xylem added smart metering, network technologies and advanced data analytics for water, gas and electric utilities to its portfolio of solutions. In more than 150 countries, we have strong, long-standing relationships with customers who know us for our powerful combination of leading product brands and applications expertise with a strong focus on developing comprehensive, sustainable solutions.

For more information on how Xylem can help you, go to www.xylem.com



Xylem Analytics Germany Sales GmbH & Co. KG, WTW

Dr.-Karl-Slevogt-Straße 1
D-82362 Weilheim
Germany

Phone: +49 881 183-0
Fax: +49 881 183-420
E-Mail: Info.WTW@Xylem.com
Internet: www.WTW.com

Quotations and Orders
Phone: +49 881 183-324
Fax: +49 881 183-411
E-Mail: Order.WTW@Xylem.com

Technical Information
Phone: +49 881 183-322
Fax: +49 881 183-425
E-Mail: TechInfo.WTW@Xylem.com

Repair Service
Phone: +49 881 183-325
Fax: +49 881 183-414
E-Mail: Service.WTW@Xylem.com

All names are registered tradenames or trademarks of Xylem Inc. or one of its subsidiaries. Technical changes reserved.
© 2017 Xylem Analytics Germany Sales GmbH & Co. KG.
999194US September 2017