



Catalogue Viscometry

ViscoSystem® | AVS® | ViscoClock | Viscometers

SI Analytics

a xylem brand

Capillary viscometry from SI Analytics - know-how from the very beginning

Innovative capillary viscometry - from the outset

The viscosity of Newtonian fluids can be most precisely determined using capillary viscometers. This method of measurement, measures the time taken for a defined quantity of fluid to flow through a capillary with a known diameter and known length. With the industrial production of such precisely calibrated capillary viscometers, we have created the conditions to enable this measuring method to establish itself worldwide as a reliable procedure.

With the development of the first automatic measuring systems, we replaced the stopwatch with automatic registration of the fluid at the start of the 1970's. Since then, subjective measuring errors have been a thing of the past.

Further developments and improvements of viscometers, measuring instruments and accessories led to a range of products whose excellent performance is universally recognized. It is therefore no wonder that our viscosity measurement systems have become indispensable production control and quality insurance tools worldwide, whether in the mineral oil industry, for polymer manufacturers and processors, in the pharmaceutical or food industry.

Our capillary viscometers are the worldwide basis for precise viscosity measurements of Newtonian fluids.



Content viscometry

Applications for AVS® measurement systems	Page 4
ViscoClock	Page 6
AVS® 470	Page 8
AVS® 370	Page 12
WinVisco 370 software	Page 16
AVS® Pro III	Page 20
CT 72 Transparent Thermostats	Page 26
Viscometers and their range of use	Page 30
Ubbelohde viscometers, normal form (DIN)	Page 31
Ubbelohde viscometers, normal form (ASTM)	Page 32
Ubbelohde viscometers, with additional tube and threads	Page 33
Ubbelohde viscometers with TC sensors	Page 34
Micro-Ubbelohde viscometers with TC sensors	Page 36
Micro-Ubbelohde viscometers	Page 37
Cannon-Fenske viscometers	Page 38
Ostwald viscometers	Page 40
Accessories	Page 41
AVS® measuring stands	Page 46

visco

AVS[®] measurement systems within quality assurance systems



Business sector	Product	Example
Automotive engineering	motor oil (fresh and used)	
	high polymer plastics	bumpers
Brewery	original wort	beer
	hop-wort	beer
Electrical engineering and electronics	high polymer plastics of all types	chips, casings
Power supply	turbine oil	generators
	transformer oil	
Plastics manufacturers	high polymer plastics of all types	
Plastics processors	high polymer plastics of all types	injection molding
Food industry	starch	instant flour thickeners
	gelatin	jelly bears
	packaging materials	yogurt containers
	milk products	yogurt drink
	fruit and fruit juice concentrates	
	gelatinizing agents	pectin
Aviation	high polymer plastics of all types	
	fuels	kerosene
	hydraulic fluids	horizontal stabilizers and undercarriages
Mechanical engineering	mold oil	mill trains
	hardening emulsions	stamp shops
	hydraulic fluids	
Medicine	body fluids	blood, bile
	injection solutions	insulin
	tinctures and drops	nose, eyes
	blood substitute materials	blood plasma
Mineral oil	light motor oil	
	turbine oil	
	liquid fuels of all types	gasoline, diesel fuel, kerosene (jet fuel)
Textile	high polymer plastics of all types	for mixed fibers
	cotton	
Entertainment	high polymer plastics	CDs, DVDs

The table on the right illustrates the extensive area of high polymer plastics and the large variety of testing methods.

Polymer applications for the AVS® measurement systems

Polymers, their applications and utilization of our automatic systems

Type	Abbr.	Solvent	Capillary	Operating temperature	Standards	Suitability of the AVS® measurement systems			
						VC*	370	470	Pro
Cellulose	C I	EWN		20 °C	SNV 195598	■	■	■	■
		Cuen (CED)		20 °C	DIN EN 60450				
		Cuen (CED)		20 °C	ASTM D 4243				
		Cuen (CED)		25 °C	ISO 5351				
		Cuen (CED)		25 °C	AST; D 1795				
		Cuen (CED)		25 °C	SCAN CM 15:99				
		Cuen (CED)		25 °C	TAPPI T230-0M99				
Cellulose acetate	CA	Dimethyl-chloride/ methanol	0c I I Micro	25 °C	ASTM D817	■	■	■	■
Polyamide	PA	Sulphuric acid (96%)	II IIc	25 °C	ISO 307	■	■	■	■
Polyamide	PA	Formic acid (90%)	I Ic	25 °C	ISO 307	■	■	■	■
Polyamide	PA	m-cresol	II IIc	25 °C	ISO 307	■	■	■	■
Polybutylene terephthalate	PBT	Phenol/dichloro benzene (50:50)	Ic II	25 °C	ISO 1628-5	■	■	■	■
Polycarbonate	PC	Dichloromethane	0c I	25 °C	ISO 1628-4	■	■	■	■
Polyethylene	PE	Decahydro-naphthalene	I Ic	135 °C	ISO 1628-3 ASTM D 1601	■	■	■	■
Polyethylene terephthalate	PET	m-cresol	II IIc IIc Micro	25 °C	ISO 1628-5 ASTM D 4603	■	■	■	■
Polyethylene terephthalate	PET	Phenol/dichloro benzene (50:50)	Ic II	25 °C	ISO 1628-5 ASTM D 4603	■	■	■	■
Polyethylene terephthalate	PET	Dichloroacetic acid	II IIc Micro	25 °C		■	■	■	■
Polymethyl methacrylate	PMMA	Chloroform	0c I	25 °C	ISO 1628-6	■	■	■	■
Polypropylene	PP	Decahydro-naphthalene	I Ic	135 °C	ISO 1628-3	■	■	■	■
Polystyrene	PS	Toluene	I Ic	25 °C		■	■	■	■
Polysulphone	PSU	Chloroform	0c	25 °C		■	■	■	■
Polyvinyl chloride	PVC	Cyclohexanone	Ic	25 °C	ISO 1628-2 ASTM D 1243	■	■	■	■
Styrene-acrylonitrile copolymer	SAN	Ethyl methyl ketone	0c I	25 °C		■	■	■	■
Styrene-butadiene copolymer	SB	Toluene	0c I	25 °C		■	■	■	■

VC* = ViscoClock

■ excellent suitability; ■ can be used; ■ limited suitability for application related reasons.

This table makes no claim to completeness.

ViscoClock.

If you need more accuracy:

The ViscoClock is the economically priced introductory model in the field of automatic viscosity measurements. Manual measurements with a stopwatch and a trained eye is something of the past because time is money.

The ViscoClock

The ViscoClock is an electronic time-measuring unit used to determine absolute and relative viscosity. It consists of a stand which is used to mount a viscometer and the electronic measuring unit. The two measuring levels are integrated in the stand made of high-quality PPA synthetic material, and the electronic measuring unit is included in a PP casing. The large LCD display allows the measured values to be read off easily.

Range of use

The ViscoClock is designed for the use of our Ubbelohde viscometer, Micro-Ubbelohde viscometer or Micro-Ostwald viscometer. The ViscoClock automatically measures the flow-through time of temperature-stabilized liquids through the capillaries of the viscometer at temperatures ranging from -40 °C to 150 °C.

For temperature stabilization in the thermostatic bath, the following liquids are suitable: water, alcohol water, paraffin oil, and silicone oil. Liquid samples can be measured that qualify for use with the viscometer being used in each instance.

Accuracy

The operating time is indicated with a resolution of 1/100 sec. with quartz precision. The accuracy of 0.1 % of the measured time used to calculate the absolute and relative viscosity is indicated as measuring uncertainty with a confidence level of 95 %.

Absolute viscosity

Only the calibrated viscometers are suitable for the calculation of absolute viscosity in the temperature-stabilized, transparent thermostatic baths.

Relative viscosity

For the measurement and calculation of relative viscosity, all Ubbelohde viscometers, uncalibrated and calibrated, can be used for manual or automatic measurements.



- Simple and highly precise time measurement
- Use with common viscometers is possible
- Includes software for determination of absolute and relative viscosity, t0-extreme value test and Hagenbach correction

Advantages
ViscoClock

Technical data ViscoClock

Measuring range - time	up to 999.99 s; resolution 0.01 s	
Accuracy of time measurement	±0.01 s/± 1 digit; however no more precise than 0.1 %; indicated as measuring uncertainty with a confidence level of 95%	
Measuring range - viscosity	0.35 to 10,000 mm ² /s (cSt) the absolute, kinematic viscosity is additionally dependent on the uncertainty of the numerical value of the viscometer constant and on the measuring conditions, in particular the measuring temperature.	
Display	5-digit LCD display, 20 x 48 mm (H x W), digit height 12.7 mm, seconds indication with 2 decimal digits after the decimal point, resolution 0.01 s	
Voltage supply	low voltage U: 9 V	
Power connection	socket for low voltage connection: jack plug, internal contact Ø = 2.1 mm, plus pole at pin contact, for connection of Universal power supply TZ 1858	
Power supply	in accordance with class of protection III. degree of protection for dust and humidity IP 50 in accordance with DIN 40 050 Universal power supply TZ 1858: 100–240 V, 50–60 Hz (9 V, 550 mA) not suitable for use in areas subject to explosion hazards	
	RS232-C interface	for connection of a printer with serial interface or of a computer (PC) for documentation of the data
	Plug-in connections	4 pole circular plug, mini, DIN
	Configuration of RS232-C interface, permanently set	4,800 baud, 7 bit word length, 2 stop bits, no parity; after each measurement, the measured value is transmitted automatically. the string of digits consists of 4 digits before the decimal point, 2 digits after the decimal point, and the terminating characters CR and LF.
Ambient Conditions	Ambient temperature	+ 10 to + 40 °C for storage and transport
	Operating temperature	stand: - 40 to + 150 °C electronic measuring unit: +10 to +40 °C
	Air moisture	in accordance with EN 61 010, Part 1; max. relative humidity 80 % for temperatures up to 31 °C, decreasing linearly to 50 % of relative humidity at a temperature of 40 °C
Housing	Materials	stand: polyphthalamide (PPA) casing*: polypropylene (PP) sealing membrane: silicone
	Dimensions	~490 x 95 x 50 mm (H x W x D)
	Weight	~450 g (without viscometer) power supply unit: ~220 g
Country of origin	Federal Republic of Germany	
CE symbol	in accordance with Guideline 89/336/EWG (electromagnetic compatibility EMC): emitted interference in accordance with Standard EN 50 081, Part 1 interference immunity in accordance with Standard EN 50 082, Part 2, in accordance with Guideline 93/23/EWG (low voltage guideline), last altered by Guideline 93/68/EWG: Testing basis EN 61 010, Part 1	
Viscometer types	Ubbelohde (DIN; ISO; ASTM; Micro), Micro-Ostwald	
Transparent thermostatic baths	the ViscoClock can be used in one of our transparent thermostatic bath.	

* Use in heat carrier liquids can result in discoloration of the synthetic material. The discoloration does not, however, have any effect on the function and quality of the ViscoClock. DURAN® is a registered trademark of Duran Group. Subject to technical changes.

Precise Capillary Viscometry - Easy, Flexible and Independent: AVS® 470



No PC needed: "Suction" and "Pressure" measurements with just one instrument

The AVS® 470 is the first viscosity measurement device that allows "suction" and "pressure" measurements completely independent of a PC. This allows for maximum independence and flexibility; set up a measuring station that meets the highest requirements even under difficult conditions, e.g. to monitor production or quality control in the polymers and mineral oil industry.

Perfectly equipped for fully automatic viscosity measurements

The AVS® 470 is a measuring system that includes almost everything you need to take precise and reproducible measurements. All common types of viscosity calculation are integrated into the device, a small PS2 keyboard allows you to enter additional data. A serial printer can be used to conveniently document your results.

So, in a minimum of space, you can set up a measuring station equal in every way to complex measuring installations in terms of precision and reproducibility.



"Suction" or "Pressure"?

Preferred applications in comparison

	"Pressure"	"Suction"
highly viscous samples e.g. oils, polymers	■	■
Solvents:		
(examples) highly volatile	■	-
Dichloromethane	■	-
Chloroform	■	-
Sulfuric acid	-	■
Dichloroacetic acid	-	■
Toluene	■	■
Hexafluoro-isopropanol	■	■
m-cresol	-	■
Formic acid	-	■
Phenol-dichlorobenzene	-	■
Phenol-Tetrachloroethane	-	■

Simple and updateable Modular Concept

The AVS® 470 is of a modular design and an optional optical or TC version ViscoPump II module.

You can use your existing accessories such as thermostats, stands, flow-through coolers or automatic cleaners e.g. AVS® 26. Also, virtually all customary capillary viscometers can be used.

- ▶ Automatic and highly precise measurements - independent of a PC
- ▶ "Suction" and "pressure" measurements with the same system
- ▶ Simple data input and parameterization via included PS2-mini-keyboard
- ▶ GLP documentation compliant when connected to an optional printer

Advantages
AVS® 470

AVS® 470 - Precise and Reliable

Working with the AVS® 470 is easy

The desired measurement method can be preselected and started on the device. The entire measurement is automatic to eliminate subjective measurement errors. Once the set pre-heating time is reached, the desired number of measurements are taken and the viscometer automatically cleaned if required. The status of the measurements is continuously displayed.

If required, individual parameters may be input via an included PS 2 keyboard. A serial printer can be used to print measurement logs.

The connections are on the front panel of the device for easy control. Over-pumping and oversuction are prevented by the use of an optional capacitive sensor.

The print-out shows everything you need for reliable documentation of your test.

```

No. 1 = 77.20s
No. 2 = 77.21s
No. 3 = 77.20s

=====

*****
*                               *
*  ViscoSystem AUS470          *
*      Protocol                 *
*                               *
*****

method : absolute

Id : 11
lot: SIM Test sample
usr: A. Eich

measurements [s]
No. 1 = 77.20*
No. 2 = 77.21*
No. 3 = 77.20*

delta%choice = 0.01%
Pre temp. time = 0min

average      = 77.203s
stand. dev. = 0.006

constant = 0.029999996

AbsVisc=2.3161mm^2/s

temperature: 25.00 C
date:      05/12/2012
time:      09h 47m 27s
=====
  
```

Individually determined readings

Indication of method set

Designation of specimen

Charge Number

User

Readings used for evaluation

Set equalization time

Set maximum permissible deviation from average

Average of running times

Corrected average running time

Viscosimeter constant

Calculated Viscosity

Operating temperature, date and time at time of test

Technical data

- Clear user guidance, clear status - even without PC!

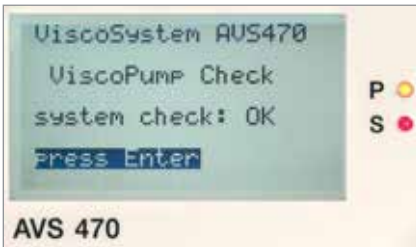

After switching on the AVS® 470 a self test is run and then an entry prompt appears.

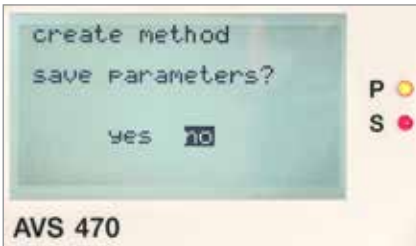

The parameters can be set in the test mode. The t_0 value is determined automatically.

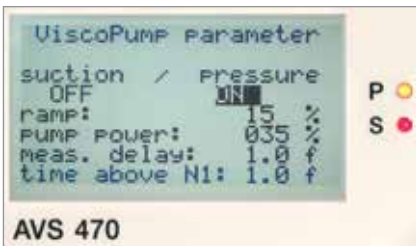

All setup parameters can be preset conveniently, e.g. pressure/suction, velocity, waiting time between two tests, etc.

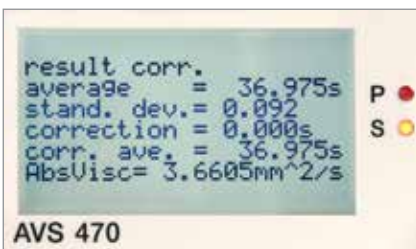

The readings can be read off conveniently on the display regardless of whether or not a printer is connected.

Measuring range (time)	up to 9,999.99 s; resolution 0.01 s	
Measuring range (viscosity)	pressure:	0.35 to 1,800 mm ² /s (cSt)
	suction:	0.35 to ~5,000 mm ² /s (cSt)
Measured parameter	flow-through time [s]	
Time measuring accuracy	± 0.01 %	
Measured value display	LC-Display	
Display accuracy	± 0.01 s, ± 1 Digit, but not exceeding 0.1%	
Pumping pressure	fully automatically controlled	
	suction up to ~-160 mbar, pressure up to ~+160 mbar	
Preselectable tempering period	0 to 20 min	
Preselectable no. of measurements	1 to 99 for each sample	
Connections	Pneumatic connections	threaded connections for viscometers
	Electrical connections	circular connector with bayonet lock for viscometer
		4-pin DIN socket for TC viscometer
		4-pin circular connector for capacitive sensor
		7-pin circular connector for AVS® 26, with bayonet lock
	RS232-C interface	9-pin for serial printer
	Mains connection	connector in acc. with EN 60320
Pump connection	socket outlet in accordance with EN 60320	
Ambient Conditions	Ambient temperature	+10 to +40 °C for operation and storage
	Air humidity	max. 80 % in acc. with EN 61010, Part 1
Housing	Material	steel aluminium housing; with chemically resistant 2-component coating
	Dimensions	(W x H x D) ~255 x 205 x 320 mm
	Weight (incl. pump module)	~5.4 kg
Power supply	90 to 240 V ~, 50 to 60 Hz	
Equipment safety	EMC in acc. with Council Directive 89/336/EWG;	
	low-voltage directive	

The AVS® 470 allows the use of the following viscometers:

Ubbelohde viscometer to DIN, Ubbelohde viscometer to ASTM, micro Ubbelohde viscometer to DIN, micro Ostwald viscometer, Cannon-Fenske routine viscometer, TC Ubbelohde viscometer, TC micro Ubbelohde viscometer.

We reserve the right to make technical changes.

AVS® is a registered trademark of SI Analytics and stands for: "Automatic Viscosity System".

AVS® 370 makes maximum precision ...

Well equipped for all viscosity determination

The AVS® 370 is a measuring device, which not only measures as precisely and consistently as you expect, but also offers maximum flexibility and future extensions. Furthermore, it saves laboratory space.

Now possible for the first time ever: "suction" and "pressure" measurement - with one device

The AVS® 370 is the first viscosity measuring device, which can be used for both "suction" and "pressure" measurement. This enables simple adjustment of the measurement method for sample. Significantly reducing investment costs for additional measuring stations at which pressure and suction methods are to be used. In most cases, using the AVS® 370 also saves set-up time.

AVS® 370



... easier and more flexible, with provision for future expansion!

Easy modular concept ideal for future expansion

The AVS® 370 has a modular design. The basic version is available with one ViscoPump II module in optical or in TC version. Up to 3 other ViscoPump II modules can be installed in the compact 19" housing. The measuring station can be adapted to increasing requirements at any time.

Can be expanded from an affordable single measuring station up to an 8-sample station

The basic version of the AVS® 370 is able to measure high or low viscosity liquids. The TC version viscometers, for example, it is ideal for measuring opaque and black fluids. If necessary, each single measuring station can be expanded to a multiple measuring station with PC-controlled multitasking. The WinVisco 370 software included with the standard equipment enables parallel operation of two fully equipped AVS® 370, with a total of eight ViscoPump II modules. Each module can measure a different sample using its own method. All the results can be quickly and easily evaluated and documented independently. It could hardly be more flexible!

Compatible with existing accessories

Existing accessories (thermostats, stands, flow through cooler, etc.) can continue to be used with the AVS® 370. Also, virtually all customary capillary viscometers can be used.

"Suction" or "pressure"?

A comparison of preferred applications

	"pressure"	"suction"
Highly viscous samples e.g. oils, polymers	■	■
Solvent: (examples)		
highly volatile	■	-
Dichlormethane	■	-
Chloroform	■	-
Sulfuric acid	-	■
Dichloroethanoic acid	-	■
Toluene	■	■
Hexafluorisopropanol	■	■
m-Cresol	-	■
Formic acid	-	■
Phenol-dichlorobenzene	-	■
Phenol-tetrachloroethane	-	■

- ▶ Automatic and highly precise measurements
- ▶ "Suction" and "pressure" measurements with the same module
- ▶ Modular concept for up to four ViscoPump II modules in one AVS® 370
- ▶ Each ViscoPump II module in a AVS® 370 can measure a different sample using a different method.
- ▶ Real multitasking for up to eight parallel measurements with the software WinVisco 370
- ▶ TC version for measurement of nontransparent and black liquids

Advantages
AVS® 370

AVS® 370 - the right solution for all situations

Anyone working with the AVS® 370 is perfectly equipped for all tasks involved in determining viscosity using capillary viscometers.

▶ How to automatically achieve the right results

PC-controlled, the AVS® 370 determines the time which the liquid to be examined requires to flow through the measuring distance in the capillary viscometer with quartz precision. The time is displayed with a resolution of 0.01 s (1 digit).

Measurement of the flow time of the liquid's meniscus can be scanned optoelectronically or with TC sensors. During optoelectronic scanning the meniscus is detected by glass light fibers, with TC sensors the sensor detects the different thermal conductivity of the sample and air. The AVS® 370 offers an extraordinarily broad range of uses, from viscosity measurement of clear fluids to black or fully opaque liquids.

▶ New: Two working principles with the same device.

With the AVS® 370 you can use one device to work with either "pressure" or "suction" offering more flexibility with the liquids to be examined.

In the "pressure" method an overpressure is applied to the liquid in the capillary, this is particularly advantageous for fluids with a low boiling point. For the "suction" principle the sample is sucked up into the capillary by a vacuum. Greater reproducibility is achieved using the "suction" method for higher viscosity samples.



370

Working with AVS® 370 is easy

The entire measurement procedure is placed automatic, subjective measuring errors are reliably eliminated. The PC starts the measurement. After the set preconditioning period the selected number of measurements processed and the measured values saved.

The system protects against accidental overpumping or oversuction by means of a capacitive sensor. This prevents the sample to be measured from getting into the vessel containing the liquid or inside the device.

Unique flexibility

In the PC-controlled multiple measurement station, the AVS® 370 offers unique flexibility while working in a very small space: Up to eight modules, which equates to two fully equipped AVS® 370, can be run in parallel with the WinVisco 370 software. Each module can measure the same or different samples using "pressure" or "suction", independent of each other. In this way, a series of measurements can be prepared quickly and immediately evaluated and documented with the computer. This significantly reduces the time required to carry out viscosity measurements, especially for in process controls and quality assurance.

Technical data

Measuring range (time)	up to 9,999.99 s; resolution 0.01 s	
Measuring range (viscosity)	pressure:	0.35 to 1,800 mm ² /s (cSt)
	suction:	0.35 to ~5,000 mm ² /s (cSt)
Measured parameter	flow through time [s]	
Accuracy of the time measurement	± 0.01 %	
Measured value display	via PC	
Display accuracy	± 1 digit (0.1 %)	
Pump pressure	automatically controlled	
Preselectable tempering period	0 to 20 min	
Preselectable number of measurements	up to 10	
Connections	Pneumatic connections	threaded connections for viscometers
	Electrical connections	circular connector with bayonet lock for measuring stands and TC viscometers
	RS232-C interface	9-pin
	Mains connections	plug in accordance with EN 60320
	Pump connection	socket outlet in accordance with EN 60320
Data Input/Output	serial to EIA RS232-C	
Ambient conditions	Ambient temperature	+ 10 to + 40 °C
	Air humidity	max. 85 % rel.
Housing	Material	coated aluminum plate
	Dimensions (for 1 to 4 modules)	(W x H x D) ~255 x 205 x 320 mm
	Weight (incl. 1 module)	~5.4 kg
Power supply	90 to 240 V ~, 50 to 60 Hz	
Equipment safety	EMC-Compatibility according to the Directive 89/336/EEC of the Council; low-voltage directive according to the Directive 73/23/EEC of the Council, as amended by the Directive 93/68/EEC of the Council	
Multi-tasking	for 1 to 8 ViscoPump II modules, with WinVisco 370 software	

The following viscometers can be used with the AVS® 370:

Ubbelohde viscometer to DIN, Ubbelohde viscometer to ASTM, micro Ubbelohde viscometer to DIN, micro Ostwald viscometer, Cannon-Fenske routine viscometer, TC-Ubbelohde viscometer, TC-micro Ubbelohde viscometer.

We reserve the right to make technical changes.

AVS® is a registered trademark of SI Analytics and stands for: "Automatic Viscosity System".

Real multitasking for up to 8 measurements in parallel mode ...

Easy to understand and proven: The WinVisco 370 software

WinVisco 370 is the ideal software for the AVS® 370*). It is supplied as part of the standard equipment. Up to eight viscosity measurement modules can be controlled with only a few operational steps. The device parameters are easy to enter: Constants, t_0 flow time, number of measurements, preconditioning period, type of viscometer, date and sample labeling for each measurement station.

WinVisco 370 works in a real multitasking mode making it possible for each measurement to be processed independently from the others. It also means that time-consuming measurements can be carried out from the same PC, without hindering the course of other, faster measurements. During the measurements you can change the monitor displays, start or stop other measurements, print or save measured values. All data provided by the software can be passed on to LIMS system.

WinVisco 370 supports three groups of users. For simple use, access is limited to: select viscometer, measure, load and save methods as well as enter parameters. In the highest level, users with administrator status can access all the software's facilities. Each user is given a user ID, an access level and a password.

*) The language (English or German) can be chosen after installation over the program menu.

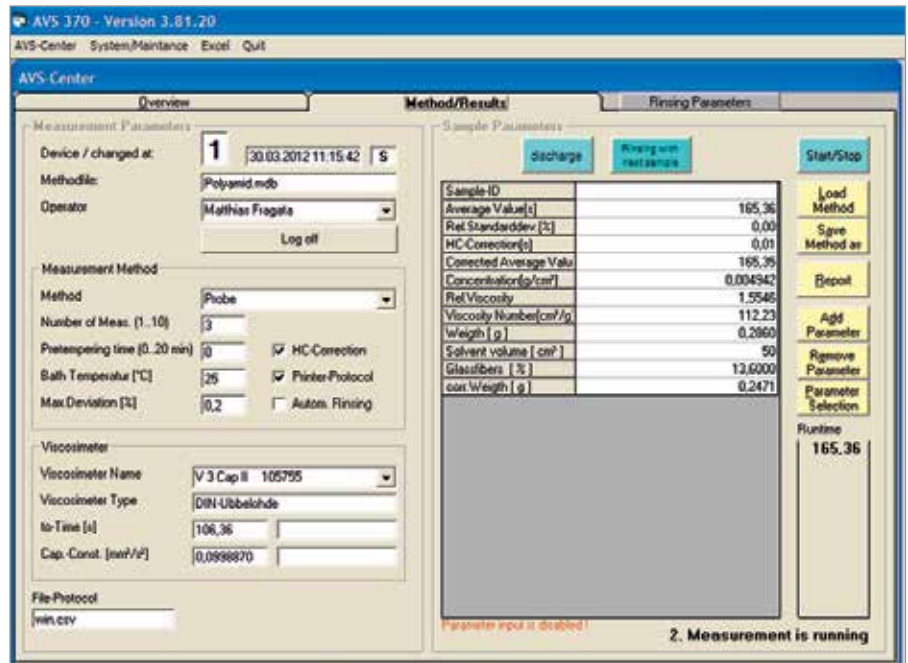

All the important parameters required for the measurement are displayed on the "Methods/Results" page. If necessary, the parameter editor can be called up using "Add Parameter", in order to enter non-standard or customer specific formulae.

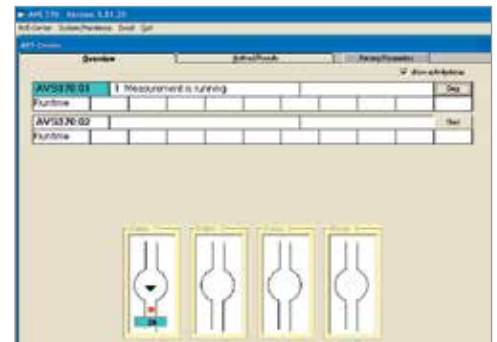

All the measurements currently running can be monitored in parallel in the overview.

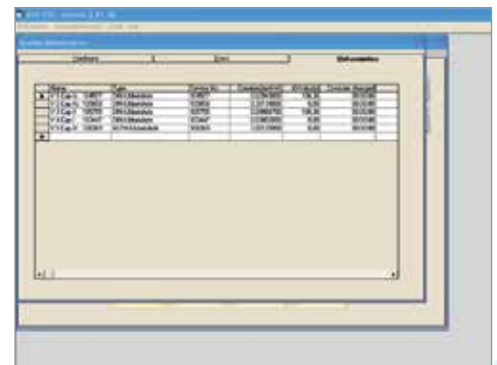

The viscometer data required for the evaluation can be stored in a table. This guarantees perfect allocation of e.g. the t_0 runtime, viscometer constants, the series number, etc. for each individual viscometer being used.

... with the proven WinVisco 370 software

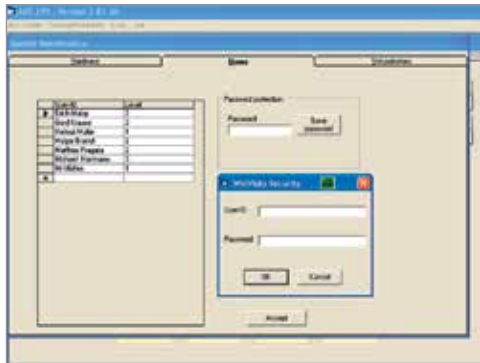

The password protection prevents unwanted changes to the important measurement parameters.

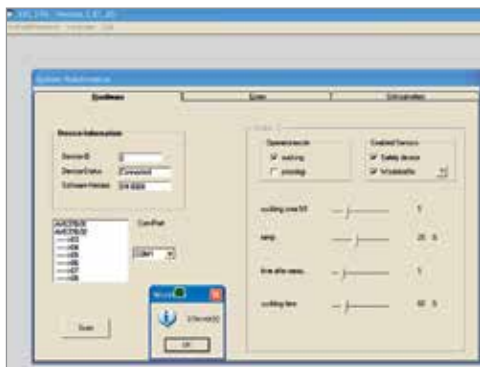

The parameters can be individually adjusted to the measurement for each measuring position.

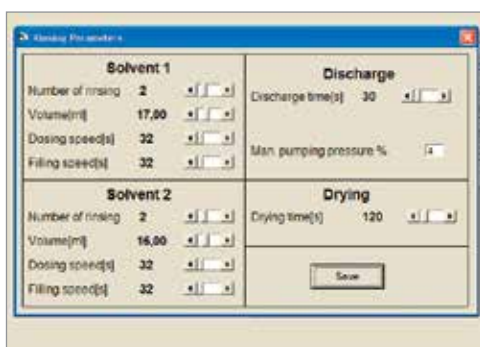

Each rinse/dry step can be individually pre-selected. Even the application dependent quantity of solvent and the drying time can be separately determined.

- With AVS® 370 and WinVisco 370 the right connection for rinsing can be quickly determined

With the daisy chain link of the AVS® 370, additional devices can be integrated with the system and controlled using the WinVisco 370 software. For example, when working in suction mode the viscometers can be rinsed using the TITRONIC®300 or the TITRONIC® 500 burettes. The TITRONIC®300 is preferable used for light solvents, the TITRONIC® 500 for solvents with a viscosity >3 mm²/s. For highly aggressive solvents special changeable modules are available (TA50V and WA50V).

A vacuum pump (accessory) integrated with the system can be used to conveniently remove samples and solvents.

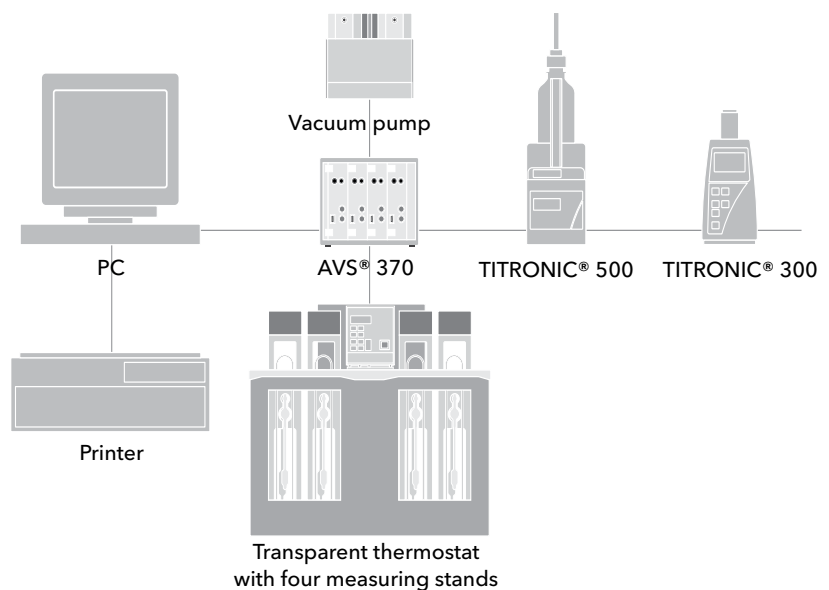

Two basic concepts are available for the rinsing:

- An AVS® 370 with up to four ViscoPump II modules (max. four measurement positions) and up to eight burettes, which enables each viscometer to be rinsed with two solvents. Time consuming removal of the transparent thermostat for external rinsing of the viscometer is no longer necessary.
- Two AVS® 370 complete with up to four ViscoPump II modules each (max. eight measuring positions), which enables semi-automatic rinsing of the viscometer with the next sample or solvent.

VISCO® 370

Ordering information AVS® 470



Ordering information AVS® 370



The AVS® 470 viscosity test station is composed of individual components.

Please request a detailed quote.

Type no.	Order no.	Description
AVS® 470 basic unit for opto-electronic sensing	285415709	AVS® 470 basic unit, housing incl. one ViscoPump II module for opto-electronic sensing, Keyboard Version: 95 V to 230 V/50-60 Hz
AVS® 470 basic unit for TC sensing	285415708	AVS® 470 basic unit, housing incl. one ViscoPump II module for TC sensing, Keyboard Version: 95 V to 230 V/50-60 Hz
VZ 8511	1054306	ViscoPump II module for optical sensing
VZ 8512	1054304	ViscoPump II module for TC sensing

The AVS® 370 viscosity test station is composed of individual components.

Please request a detailed quote.

Type no.	Order no.	Description
AVS® 370 basic unit for opto-electronic sensing	1056509	AVS® 370 basic unit, housing incl. one ViscoPump II module and WinVisco 370 software, for opto-electronic sensing
AVS® 370 basic unit for TC sensing	1056515	AVS® 370 basic unit, housing incl. one ViscoPump II module and WinVisco 370 software, for TC sensing
VZ 8511	1054306	ViscoPump II module for optical sensing
VZ 8512	1054304	ViscoPump II module for TC sensing

Accessories AVS® 470 and AVS® 370

Type no.	Order no.	Description
CT 72/P, 230V	285418526	Immersion thermostat 230 V and thermostatic bath (acrylic glass container with two manual gauge slides), basic configuration for the attachment of one flow-through cooler.
CT 72/P, 115V	285418513	Immersion thermostat 115 V and thermostatic bath (acrylic glass container with two manual gauge slides), basic configuration for the attachment of one flow-through cooler.
CT 72/2, 230V	285418547	Immersion thermostat 230 V and thermostatic bath (stainless steel container with one manual gauge slide), basic configuration for the attachment of one flow-through cooler.
CT 72/2, 115V	285418532	Immersion thermostat 115 V and thermostatic bath (stainless steel container with one manual gauge slide), basic configuration for the attachment of one flow-through cooler.
CT 72/4, 230V	285418568	Immersion thermostat 230 V and thermostatic bath (stainless steel container with two manual gauge slides), basic configuration for the attachment of one flow-through cooler.
CT 72/4, 115V	285418554	Immersion thermostat 115 V and thermostatic bath (stainless steel container with two manual gauge slides), basic configuration for the attachment of one flow-through cooler.
Z 900	285225620	RS232-C Data printer (230 V)
Measuring stand AVS®/S	285410502	Metal measuring stand AVS®/S, preferably for nonaqueous bath fluids
Measuring stand AVS®/SK	285410876	PVDF measuring stand AVS®/SK, corrosion-free, suitable for aqueous and nonaqueous bath fluids
Measuring stand AVS®/SK-CF	285410892	PVDF measuring stand AVS®/SK-CF, particularly for the use of Cannon-Fenske routine viscometers
Measuring stand AVS®/SK-V	285410905	PVDF measuring stand AVS®/SK-V, particularly for the use of dilution viscometers
CK 300, 115V	285414331	CFC-free flow-through cooler for enhancing the temperature constancy of the bath fluid (according to configuration and environmental conditions are ± 0.02 K possible) or for measurement at room temperature or below (min. +5 °C).
CK 300, 230V	285414348	CFC-free flow-through cooler for enhancing the temperature constancy of the bath fluid (according to configuration and environmental conditions are ± 0.02 K possible) or for measurement at room temperature or below (min. +5 °C).
05392	285405043	Fixing frame for Ubbelohde viscometers (not TC)

Automatic viscosity measurement has been improved ...



The AVS® Pro III automatic sampler is a fully automated instrument for determining the viscosity of Newtonian fluids with capillary viscometers. In spite of the high sample throughput, the AVS® Pro III provides maximum accuracy and reproducibility. Furthermore, working with the automatic sampler is easy and allows unattended 24-hour operation.

Particularly with time consuming measurement runs, the AVS® Pro III helps to substantially reduce the burden on qualified users. The fully automatic mode offers an increased level of safety when handling aggressive media, e.g. sulphuric acid.

The ProClean system and the microdosing make routine operation safer. The filtration of solutions, which occasionally may be harmful, may be omitted. The capacitive sensors in the suction pipe effectively prevent any damage of the measurement system.

The AVS® Pro III automatic sampler works with the capillary method, which is the most precise method for determining the viscosity of Newtonian liquids in terms of physical chemistry. The great versatility offered by vis-cometers with optical and TC sensing systems opens up an extremely wide range of applications. This includes measurements of clear liquids as well as opaque petroleum products.

... with the AVS[®] Pro III Automatic Sampler:

*Two different sample racks are supplied:
a) one rack with 56 positions for 20 ml sample bottles for micro-viscometer applications*



b) one rack with 16 positions to accommodate 100 ml sample bottles for normal volume applications



The electric sample lift ensures positioning of the samples in the rack at a convenient and easily monitored working height.

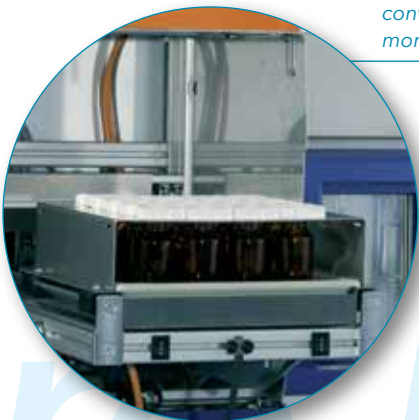

The viscosity measurement requirements of the polymer and petroleum industries in particular have been incorporated into the design of the AVS[®] Pro III. The main feature of the automatic unit is the three-axis positioning mechanism of the sample dosing system. The X-Y-Z positioning mechanism allows operation of up to four Micro TC viscometers in two thermostatic baths, which can be set at two different measurement temperatures. This method is used in oil industry in order to determine the viscosity index.

The AVS[®] Pro III allows the operator to select the sample sequence and which sample is to be filled into which viscometer. The dosing system is available in either normal or micro construction and operates without a valve. It is thus suitable for nearly any type of sample.

The AVS[®] Pro III is equipped with opto-electronic and TC scanning (TC = thermal conductivity method) functions for the meniscus passage in the capillary viscometer. The samples are positioned in the easy-to-load sample rack, using the motorized lifting mechanism. If needed, the rack can be temperature-regulated.

- ▲ Fully automatic and highly precise measuring station. Time measurement with a precision of +/- 0.01s (but less precise than 0.1%)
- ▲ Ideal for highly aggressive media
- ▲ Although in combination of optical and thermal sampling of the meniscus channel or different capillary sizes and types, up to four viscometers selectable
- ▲ The ProClean system and micro-dosing eliminate dangerous manual filtration of the sample

Advantages
AVS[®] Pro III

Working with the AVS® Pro III is ...

The AVS® Pro III is controlled by a PC, connected via RS232-C interface. The intuitive user interface guides the user clearly through the program. All data inputs are made using the computer keyboard and mouse.

A faulty operating status is indicated by acoustic or optical signals such as arrows, icons and other status messages or request messages. During the entire work sequence, the respective status of the AVS® Pro III is documented on the computer screen. Furthermore, status indicators can be selected for each individual measuring position, which provide additional information on operation.

For the respective type of measurement, pre-parameterized sets of parameters depending on the viscometers, temperature and other measurement criteria are already provided. In addition, all parameters can be individually adjusted to special requirements at a special menu level. All of the standard calculation methods are available.

The proved and tested AVS® Pro III software also makes it possible to prepare additional individually selected calculations, such as:

- mean value,
- standard deviation,
- outlier test (A %),
- Hagenbach correction,
- absolute viscosity, dynamic viscosity (density value required),
- viscosity index (measurement at two temperatures required),
- SUS and SFS,
- relative viscosity,
- specific viscosity,
- reduced viscosity (viscosity number),
- inherent viscosity
- intrinsic viscosity and
- K-value after Fikentscher

During the entire process, all of the parameters (depending on the menu level) and the respective status of the individual measuring positions, the temperature regulation system and the sample transfer system are either visible or can be selected.

The operator interface of the AVS® Pro III is available in German and English. Commercially available printers for which Windows drivers are available are suitable for documentation purposes.

Precision, reproducibility and comparability comply with DIN 51 562-1(1999-01), ASTM D 445 and ISO 3105 standards.

The AVS® Pro III is built in accordance with international equipment safety standards: CE symbol (equipment safety, low voltage safety, emitted interference and interference immunity).

If requested, the AVS® Pro III automatic sampler can be supplied with a manufacturer's inspection certificate based on direct comparison with normal viscometers of the first order in accordance with DIN 51 562 - 4: 1999-01.

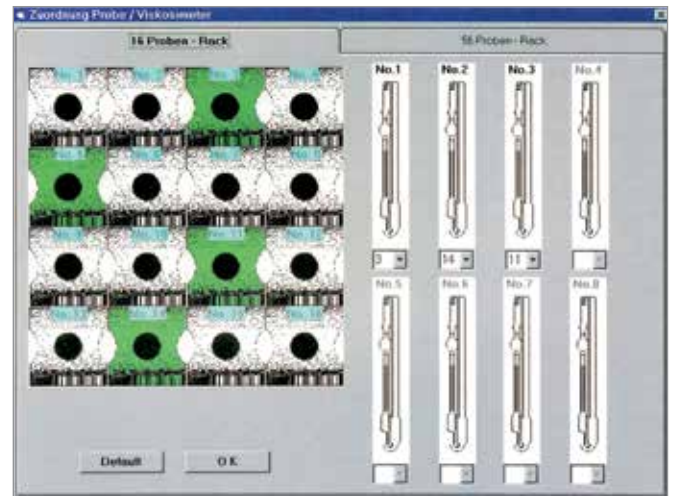

›16 sample rack‹

The AVS® Pro III allows individual allocation between the characteristics of the sample and the viscometers that are currently in operation.

... easy, reliable and safe

This means that it is not only possible to simultaneously test the characteristics of samples with greatly differing viscosities, but also to perform measurements in various capillary sizes and different types of viscometers. This even applies to a combination of optical and thermal scanning. Therefore, preliminary sorting of the samples with regard to viscosity and the size of capillary required for the testing process is not necessary.

It is possible to "individually" allocate each sample to a capillary viscometer that is currently being used by means of the conventional MS-Windows® "drag and drop" method.

The allocation between the sample and the viscometer is shown on the status display.

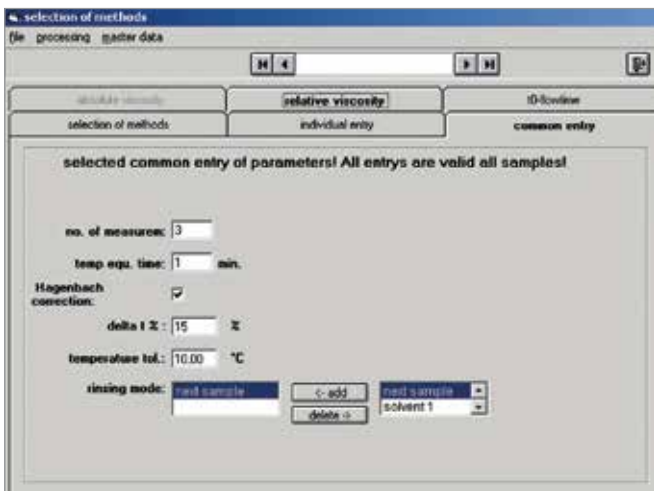

›selection of method‹

This mode is used to specify what monitoring parameters are to be activated, e.g. if the temperature control of the thermostats is supposed to be handled via the PC.

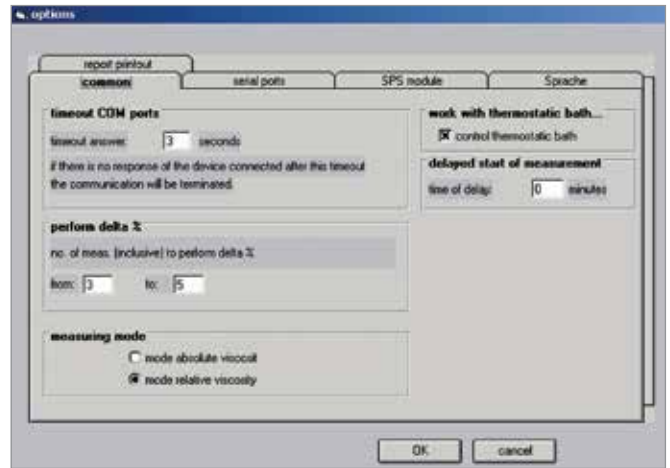

›options‹

This mode is used to specify the number of measurements, the preliminary temperature regulation period, the allowable standard deviation, the maximum allowable temperature tolerance, the rinsing type and method of the viscometer.



›dosing parameters‹

This mode is used to specify the filling quantity of the viscometer, the dosing speed depending on the viscosity and the type of rinsing.



Technical data AVS[®] Pro III



Sampling system	Sample bottles	100 ml screw-type and bottles with standard ground joint (16 pcs per rack)
		20 ml round bottom glass pieces (56 pcs. per rack)
	Sample rack	for 100 ml screw-type and bottles with standard ground joint
		for 100 ml screw-type and bottles with standard ground joint (temperature controlled up to 135°C)
		for 20 ml round bottom glass pieces
Measured value recording	Method	meniscus scanning by means of opto-electronic system or thermal conductivity (TC)
Measuring parameter		throughput time in seconds [s]
		temperature in degrees Celsius [°C]
Calculated parameters		mean value, standard deviation, outlier test (A %), Hagenbach correction, absolute viscosity, dynamic viscosity (knowledge of density required), viscosity index (measurement at two temperatures required) SUS and SFS, relative viscosity, specific viscosity, reduced viscosity (viscosity number), inherent viscosity, K-value
Selection parameters		by means of PC keyboard, mean value, standard deviation, outlier test (A %), Hagenbach correction, absolute viscosity, dynamic viscosity (knowledge of density required), viscosity index (measurement at two temperatures required) SUS and SFS, relative viscosity, specific viscosity, reduced viscosity (viscosity number), inherent viscosity, K-value, rack position, date/time, temperature regulation period, number of measurements, number of rinsing operations, start, stop/reset
	Number of measurements	1 to 99
	Temperature regulation period	0 to 99 min., selectable in increments of 1 min.
	Number of Viscometer tests	0 to 9 with next sample (observe sample quantity) or with preselected rack position
	Data memory	by means of PC
Viscosity measurement range		0.35 to 1,200 mm ² /s (at room temperature of samples)
	Time	up to 9999.99 s, resolution = 0.01 s
	Vacuum pressure	automatically controlled
	Viscometers available for use	Ubbelohde viscometer in accordance with DIN standards
		Ubbelohde viscometer in accordance with ASTM standards
		Micro-Ubbelohde viscometer in accordance with DIN standards
		Micro-Ostwald viscometer Cannon-Fenske-Routine visco
		Cannon-Fenske-Routine viscometer
		TC Ubbelohde viscometer
		TC Micro-Ubbelohde viscometer

IS[®] Pro III

Measuring accuracy	±0.01 s ± 1 digit, but not more precise than 0.01 %	
	The measuring uncertainty for measurements of absolute kinematic viscosity is also dependent on the uncertainty of the numeric value for the viscometer constant and on the measuring conditions, especially the measuring temperature.	
Evaluations / results	Correction	Hagenbach correction (HC) for Ubbelohde, Cannon-Fenske-Routine, Micro-Ubbelohde and Micro-Ostwald viscometers
	Statistical evaluation	standard deviation, outlier search
Ambient conditions	Ambient temperature	10 to +40 °C
	Air humidity	max. 85 % relative humidity
Equipment safety	CE-symbol	in accordance with Guideline 89/336/EEC of the Council (EMC compatibility)
		in accordance with Standard EN 50 081, Part 1;
		interference immunity in accordance with Standard EN 50 082, Part 2;
		in accordance with Guideline 73/23/EEC of the Council (low-voltage guideline)
Housing	plastic/stainless steel / aluminium casing with chemically resistant two-component coating of the plastic pieces	
	Dimensions	w = 1,300 mm, h = 1,000 mm, d = 620 mm (~51" x 43" x 24")
	Weight	dependent on the number of measuring positions ~70 kg
Connections	Pneumatic connections	screw-type connections for viscometer
	Electric connections	circular connectors with bayonet lock for measuring stand and TC viscometer
	Viscometers	up to 8 viscometers connected by individual control units
	Temperature	via serial interface RS232-C of suspended thermostat, type: 1 pc. CT 72/4 or up to 2 pcs. CT 72/2
	Interfaces	control system using PC with 2 x RS232-C interfaces
	Safety	overflowing safety device of waste bottle and suction hose
	Mains connection	European built-in plug DIN 49 457 6 with fuse
	Data transmission	Interface internal
Interface external		via PC, bidirectional serial interface in accordance with EIA RS232-C
Power supply	Mains voltage	230 V (AC) or 115 V (AC), 50 to 60 Hz (AC)

CT 72 Thermostat Series - Transparent Thermostats conforming to Standards



CT 72/4

CT 72

As their predecessor CT 52 the new transparent thermostats CT 72/P, CT 72/2, CT 72/2-TT and CT 72/4 meet DIN 51 562 (part 1), ASTM D 445 and ISO 3105 standards.

The SI Analytics transparent thermostats are particularly designed for the determination of the viscosity of newtonian liquids in glass capillary viscometers. They may be adapted for manual as well as for automatic measurements. The new models offer the core features of the CT 52 series incorporating the new improved immersion thermostats.



CT 72/2



Bright display shows ongoing process, at any time.

- ▶ CT 72/2 and CT 72/4 can be used up to 150 °C. High temperature version is standard.
- ▶ Draining valve comes with CT 72/2, CT 72/2-TT and CT 72/4.

Advantages
baths

- ▶ Programmable set temperatures through integrated clock with controller.
- ▶ Display of the momentary and the set temperature.
- ▶ Increased safety from separate operation and temperature safety sensors.
- ▶ Over-temperature safety system on front panel.
- ▶ Automatic fuses on the back panel.
- ▶ Output of data formats via RS232 connection.

New
immersion
thermostats

Transparent Thermostats conforming to Standards: The CT 72 series



Suitable temperature control liquids

Liquid	Alcohol	Water	Paraffine oil	Silicon oil
Temperature range	-40 °C to +10 °C	+5 °C to +80 °C	+40 °C to +150 °C	+80 °C to +150 °C

Technical data

	CT 72/P	CT 72/2-TT	CT 72/2	CT 72/4
Working temperature	+10 °C to +60 °C	-40 °C to +150 °C	+5 °C to +150 °C	+5 °C to +150 °C
Measuring positions for AVS	2	2	2	4
Measuring positions TC	2	2	2	4
Measuring positions micro TC	2	2	2	4
Temperature stability according DIN 58 966 at 25 °C	±0.01 K	±0.01 K	±0.01 K	±0.01 K
Size (W x H x D in mm)	355 x 370 x 250	355 x 370 x 250	355 x 370 x 250	605 x 370 x 250
Filling volume	18 l	15 l	15 l	27 l
Material	PMMA	St. steel & glass	St. steel & glass	St. steel & glass
Weight (empty)	~5 kg	~14 kg	~13.5 kg	~28 kg

At applications within normal temperature range (+5 °C up to approx. +40 °C) cooling will be necessary for maintaining temperature stability.

Ordering information

Type no.	Order no.	Description
CT 72/P, 230V	285418526	Immersion thermostat 230 V and thermostatic bath (acrylic glass container with two manual gauge slides), basic configuration for the attachment of one flow-through cooler.
CT 72/P, 115V	285418513	Immersion thermostat 115 V and thermostatic bath (acrylic glass container with two manual gauge slides), basic configuration for the attachment of one flow-through cooler.
CT 72/2, 230V	285418547	Immersion thermostat 230 V and thermostatic bath (stainless steel container with one manual gauge slide), basic configuration for the attachment of one flow-through cooler.
CT 72/2, 115V	285418532	Immersion thermostat 115 V and thermostatic bath (stainless steel container with one manual gauge slide), basic configuration for the attachment of one flow-through cooler.
CT 72/2-M, 230V	285418584	Immersion thermostat 230 V and thermostatic bath (stainless steel container with one manual gauge slide), equipped with two magnetic stirrer positions. Basic configuration for the attachment of one flow-through cooler.
CT 72/2-M, 115V	285418593	Immersion thermostat 115 V and thermostatic bath (stainless steel container with one manual gauge slide), equipped with two magnetic stirrer positions. Basic configuration for the attachment of one flow-through cooler.
CT 72/2-TT, 230V	285418615	Immersion thermostat 230 V and thermostatic bath (stainless steel container with one manual gauge slide), basic configuration for the attachment of one flow-through cooler.
CT 72/2-TT, 115V	285418607	Immersion thermostat 115 V and thermostatic bath (stainless steel container with one manual gauge slide), basic configuration for the attachment of one flow-through cooler.
CT 72/4, 230V	285418568	Immersion thermostat 230 V and thermostatic bath (stainless steel container with two manual gauge slides), basic configuration for the attachment of one flow-through cooler.
CT 72/4, 115V	285418554	Immersion thermostat 115 V and thermostatic bath (stainless steel container with two manual gauge slides), basic configuration for the attachment of one flow-through cooler.
CT 72/E, 230V	285418501	Immersion thermostat 230 V/50 Hz
CT 72/E, 115V	285418495	Immersion thermostat 115 V/60 Hz
More Accessories and spare parts		
CK 300, 230V	285414348	Flow through cooler, 230 V
CK 300, 115V	285414331	Flow through cooler, 115 V
CK 310, 230V	285414320	Flow through cooler, 230 V, stainless steel version
CK 310, 115V	285414310	Flow through cooler, 115 V, stainless steel version
VZ 5210	1007628	CT 72 retrofit set for CT 62-thermostatic bath, contains: Immersion thermostat CT72/E-230 V, adapter plate and cooling devices
VZ 5213	285420397	CT 72 retrofit set for CT 62-thermostatic bath, contains: Immersion thermostat CT72/E-115 V, adapter plate and cooling devices
VZ 5402	285415171	Manual gauge slide for transparent thermostats
VZ 5403	285420684	3-fold manual gauge slide for transparent thermostats
VZ 5404	285418573	Dust protection cover for transparent thermostat
VZ 5405	285418620	Transparent thermostatic bath backlight
VZ 7100	285421051	Control thermometer measuring range +19 to +21 °C
VZ 7101	285421068	Control thermometer measuring range +24 to +26 °C
VZ 7102	285421076	Control thermometers measuring range +29 to +31 °C
VZ 7103	285421084	Control thermometers measuring range +39 to +41 °C
VZ 7104	285421092	Control thermometers measuring range +99 to +101 °C
VZ 7105	285421105	Control thermometers measuring range +134 to +136 °C

Viscometers and their range of use

Measurement substance property	Viscometer type							
	Ubbelohde	Micro Ubbelohde	TC Ubbelohde	Ostwald	Micro Ostwald	Cannon-Fenske-Routine	Cannon-Fenske reverse flow	
Transparent liquids manual measurement	++	++	-	+	+	+	o	
Transparent liquids automatic measurement	++	++	+	-	+	+	-	
Opaque liquids manual measurement	-	-	-	-	-	-	+	
Opaque liquids automatic measurement	-	-	++ ¹⁾	-	-	-	-	
Foaming liquids	o	o	o	+	+	+	o	
Liquid mixture with highly volatile components	o	o	o	+	+	+	o	
Minimum measurement substance and/or rinsing agent quantities	-	++	-	-	+	-	-	
High-temperature or low-temperature measurements	+	+	+	o	o	o	o	

Selection of glass capillary viscometers

- ++ use preferably
- + highly suitable
- o less suitable
- unsuitable

- ¹⁾ up to 30,000 mm²/s
- ²⁾ above 30,000 mm²/s

Ubbelohde viscometers, normal form (DIN)

Viscometers with suspended level for determination of absolute and relative kinematic viscosity of liquids with Newtonian flow behavior. The calibrated viscometers are delivered with manufacturer's certificate in accordance with DIN 55 350, Part 18. All viscometers are provided with ring marks. This ensures that viscometers for automatic measurements

can also be checked by means of manual measurements. The recommended minimum flowthrough time is 200s for absolute measurements of kinematic viscosity. For relative measurements (polymer analytics), the minimum flow time of 50s is allowed by ISO 1628-1 (depending on the capillary size).

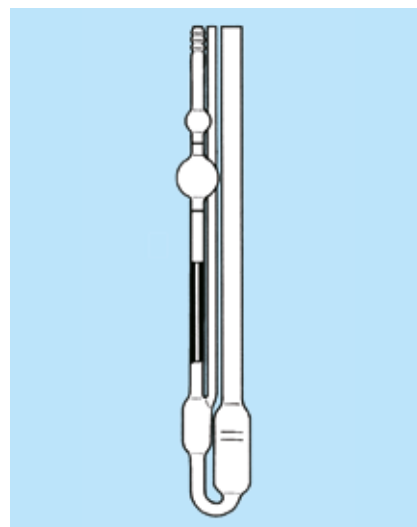

Ubbelohde-Viskosimeter (DIN)

- in accordance with DIN 51 562 Part 1, ISO/DIS 3105 (BS-IP-SL)
- filling quantity: 15 to 20 ml
- overall length: approx. 290 mm

calibrated,
with constant,
for manual measurements

calibrated
with constant,
for manual measurements;
automatic measurement
with stand AVS®/SK-HV

$$v = K \cdot t$$

$$K = \frac{v}{t}$$

$$t = \frac{v}{K}$$

Type No.	Order No.	Type No.	Order No.	Capillary No. acc. DIN	Capillary Ø i ± 0,01 [mm]	Constant K (approx.)	Measuring range [mm ² /s] (approx.)
501 00	285400004	-	-	0	0.36	0.001	0.3 to 1
501 03	285400012	-	-	0c	0.47	0.003	0.5 to 3
501 01	285400029	-	-	0a	0.53	0.005	0.8 to 5
501 10	285400037	-	-	I	0.63	0.01	1.2 to 10
501 13	285400045	-	-	Ic	0.84	0.03	3 to 30
501 11	285400053	-	-	Ia	0.95	0.05	5 to 50
501 20	285400061	-	-	II	1.13	0.1	10 to 100
501 23	285400078	-	-	IIc	1.50	0.3	30 to 300
501 21	285400086	-	-	IIa	1.69	0.5	50 to 500
501 30	285400094	-	-	III	2.01	1	100 to 1,000
501 33	285400107	-	-	IIIc	2.65	3	300 to 3,000
501 31	285400115	-	-	IIIa	3.00	5	500 to 5,000
501 40	285400123	-	-	IV	3.60	10	1,000 to 10,000
-	-	502 43	285400131	IVc	4.70	30	3,000 to 30,000
-	-	502 41	285400148	IVa	5.34	50	6,000 to 30,000
-	-	502 50	285400156	-	6.30	100	> 10,000

not calibrated,
without constant;
for determination of
relative viscosity

calibrated,
with constant for
automatic measurements

$$v = K \cdot t$$

$$K = \frac{v}{t}$$

$$t = \frac{v}{K}$$

v = kinematic viscosity in mm²/s
K = constant [mm²/s]
t = flow-through time in s

Type No.	Order No.	Type No.	Order No.	Capillary No. acc. DIN	Capillary Ø i ± 0,01 [mm]	Constant K (approx.)	Measuring range [mm ² /s] (approx.)
-	-	532 00	285400164	0	0.36	0.001	0.3 to 1
530 03	285400304	532 03	285400201	0c	0.47	0.003	0.5 to 3
530 01	285400312	532 01	285400218	0a	0.53	0.005	0.8 to 5
530 10	285400329	532 10	285400226	I	0.63	0.01	1.2 to 10
530 13	285400337	532 13	285400234	Ic	0.84	0.03	3 to 30
530 11	285400338	532 11	285400172	Ia	0.95	0.05	5 to 50
530 20	285400345	532 20	285400242	II	1.13	0.1	10 to 100
530 23	285400353	532 23	285400259	IIc	1.50	0.3	30 to 300
530 21	285400350	532 21	285400189	IIa	1.69	0.5	50 to 500
530 30	285400361	532 30	285400267	III	2.01	1	100 to 1,000
530 33	285400378	532 33	285400275	IIIc	2.65	3	300 to 3,000
530 31	285400370	532 31	285400197	IIIa	3.00	5	500 to 5,000
530 40	285400386	532 40	285400283	IV	3.60	10	1,000 to 10,000

Ubbelohde viscometers, normal form (ASTM)

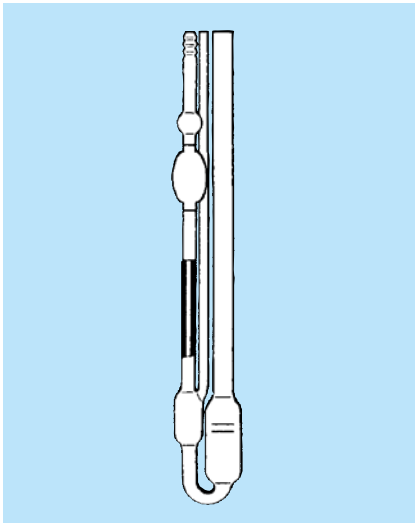

Ubbelohde Viscometer (ASTM)

- in accordance with ISO 3105, ASTM D 2515, ASTM D 446
- filling quantity: 15 to 20 ml
- overall length: approx. 285 mm

calibrated,
with constant for manual
measurements

not calibrated,
without constant for
determination of relative
Viscosity

calibrated,
with constant for
automatic measurements

Type No.	Order No.	Type No.	Order No.	Type No.	Order No.	Capillary No.	Capillary Ø $i \pm 0,01$ [mm]	Constant K (approx.)	Measuring range [mm ² /s] (approx.)
525 00	285400501	526 00	285400707	527 00	285401255	0	0.24	0.001	0.35 to 1
525 03	285400518	526 03	285400715	527 03	285401271	0c	0.36	0.003	0.6 to 3
525 01	285400526	526 01	285400723	527 01	285401263	0b	0.46	0.005	1 to 5
525 10	285400534	526 10	285400731	527 10	285401152	I	0.58	0.01	2 to 10
525 13	285400542	526 13	285400748	527 13	285401169	Ic	0.78	0.03	6 to 30
525 11	285400550	526 11	285400750	527 11	285401170	Ib	0.88	0.05	0 ... 50
525 20	285400559	526 20	285400756	527 20	285401177	II	1.03	0.1	20 to 100
525 23	285400567	526 23	285400764	527 23	285401185	IIc	1.36	0.3	60 to 300
525 30	285400575	526 30	285400772	527 30	285401193	III	1.83	1	200 to 1,000
525 33	285400583	526 33	285400789	527 33	285401288	IIIc	2.43	3	600 to 3,000
525 40	285400591	526 40	285400797	527 40	285401296	IV	3.27	10	2,000 to 10,000
525 43	285400604	526 43	285400801	527 43	285401309	IVc	4.32	30	6,000 to 30,000

Ubbelohde

Ubbelohde viscometers, with additional tube and threads

Viscometers with suspended level for determination of absolute or relative kinematic viscosity. These viscometers are preferably used for automatic measurements. The additional filling and cleaning tube and the glass thread ensure safe operational use. The calibrated viscometers are deliv-

ered with manufacturer's certificate in accordance with DIN 55 350, Part 18. The ring marks present serve as auxiliary marks in case the viscometers must be checked by manual measurements.

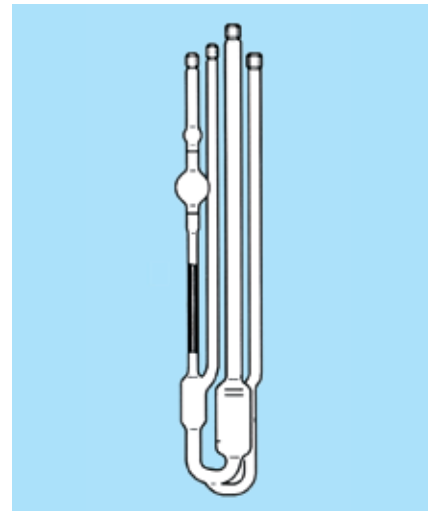

Ubbelohde viscometer (DIN)

- in accordance with ISO 3105, DIN 51 562, Part 1, BS 133, NFT 60-100
- filling quantity: 18 to 22 ml
- overall length: approx. 290 mm

calibrated,
with constant for automatic
measurements

Type No.	Order No.	Capillary No.	Capillary Ø i [mm]	Constant K (approx.)	Measuring range [mm ² /s] (approx.)
541 03	285401925	0c	0.47	0.003	0.5 to 3
541 01	285401917	0a	0.53	0.005	0.8 to 5
541 10	285401933	I	0.63	0.01	1.2 to 10
541 13	285401941	Ic	0.84	0.03	3 to 30
541 11	285401950	Ia	0.95	0.05	5 ... 50
541 20	285401958	II	1.13	0.1	10 to 100
541 23	285401966	IIc	1.50	0.3	30 to 300
541 21	285408719	IIa	1,69	0,5	50 ... 500
541 30	285401974	III	2.01	1	100 to 1,000
541 33	285401982	IIIc	2.65	3	300 to 3,000
541 40	285401999	IV	3.60	10	1,000 to 6,000

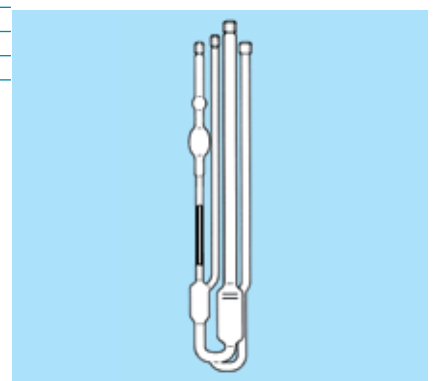

Ubbelohde viscometer (ASTM)

- the technical measurement characteristics are in accordance with ISO 3105, ASTM D 2515, ASTM D 446
- filling quantity: 15 to 22 ml
- overall length: approx. 290 mm

calibrated,
with constant for automatic measurements

Type No.	Order No.	Capillary No. acc. DIN	Capillary Ø i [mm]	Constant K (approx.)	Measuring range [mm ² /s] (approx.)
545 00	285402005	0	0.24	0.001	0.35 to 1
545 03	285402021	0c	0.36	0.003	0.6 to 3
545 01	285402013	0b	0.46	0.005	1 to 5
545 10	285402038	I	0.58	0.01	2 to 10
545 13	285402046	Ic	0.78	0.03	6 to 30
545 20	285402054	II	1.03	0.1	20 to 100
545 23	285402062	IIc	1.36	0.3	60 to 300
545 30	285402079	III	1.83	1	200 to 1,000
545 33	285402087	IIIc	2.43	3	600 to 3,000
545 40	285402095	IV	3.27	10	2,000 to 10,000
545 43	285402108	IVc	4.32	30	6,000 to 30,000

Ubbelohde viscometers with TC sensors

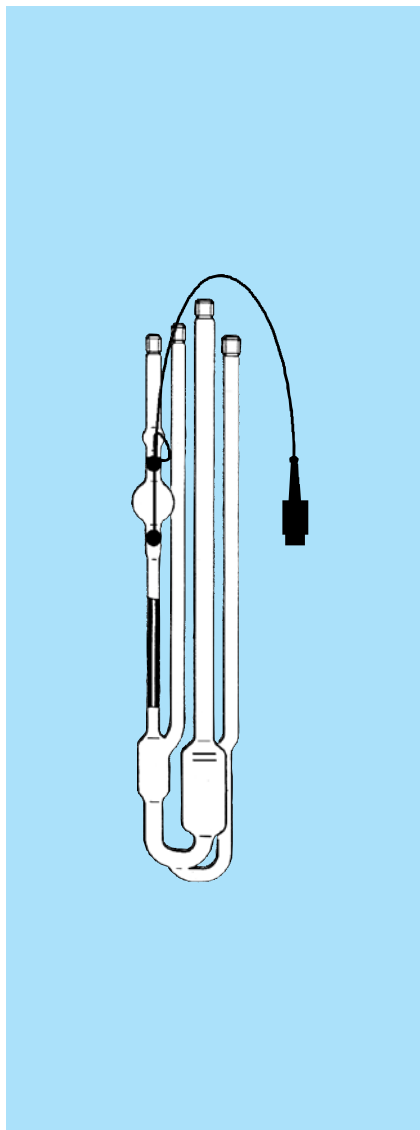

Viscometers with suspended level for determination of absolute and relative kinematic viscosity of liquids with Newtonian flow behavior. The measuring levels are marked by TC sensors. The meniscus passage is detected due to the different conductivity of the liquid phase and the gas phase. A measurement stand of the type series AVS®/S is not required. TC viscometers can be used to determine the kinematic viscosity of all liquids with Newtonian flow behavior.

They are especially suitable for liquids that cannot be detected with other systems: opaque and/or black and/or electrically conductive samples.

Due to the electrical properties of TC sensors, it is important to ensure that a suitable type is selected for the required application temperature.

TC viscometers with additional filling and cleaning tube and with glass thread

- the technical measurement characteristics are in accordance with DIN 51 562, part 1, ISO 3105 (BS-IP-SL)
- for use in combination with an automatic viscosity measuring instrument
- filling quantity: 18 to 22 ml
- overall length: approx. 355 mm
- suitable bracket Type No. 05393, Order No. 285405035

calibrated,
with constant for automatic measurements

Type No.	Order No.	Type No.	Order No.	Type No.	Order No.	Capillary No.	Capillary Ø i [mm]	Constant K (approx.)	Measuring range [mm ² /s] (approx.)
+ 10 to + 80 °C		- 40 to + 30 °C		+ 70 to + 150 °C					
562 03	285423120	-	-	-	-	0c	0.47	0.003	0.5 to 3
562 10	285423130	563 10	285423240	564 10	285423330	I	0.54	0.01	1,2 to 10
562 13	285423140	563 13	285423250	564 13	285423340	Ic	0.84	0.03	3 to 30
562 20	285423150	563 20	285423260	564 20	285423350	II	1.15	0.1	10 to 100
562 23	285423170	563 23	285423270	564 23	285423360	IIc	1.51	0.3	30 to 300
562 21	285423160	-	-	-	-	IIa	1.69	0.5	50 to 500
562 30	285423180	563 30	285423280	564 30	285423370	III	2.05	1	100 to 1,000
562 33	285423200	563 33	285423290	564 33	285423380	IIIc	2.7	3	300 to 3,000
562 31	285423190	-	-	-	-	IIIa	3.0	5	500 to 5,000
562 40	285423210	563 40	285423300	564 40	285423390	IV	3.7	10	1,000 to 10,000
562 43	285423230	563 43	285423320	564 43	285423400	IVc	4.9	30	3,000 to 20,000
562 41	285423220	563 41	285423310	-	-	IVa	5.3	50	5,000 to 30,000

Ubbelohde viscometers with TC sensors

Viscometers with suspended level for determination of absolute and relative kinematic viscosity of liquids with Newtonian flow behaviour. The measuring levels are marked by TC sensors. The meniscus passage is detected due to the different conductivity of the liquid phase and the gas phase. A measurement stand of the type series AVS®/S is not required. TC viscometers can be used to determine the kinematic viscosity of all liquids with Newtonian flow behaviour.

They are especially suitable for liquids that cannot be detected with other systems: opaque and/or black and/or electrically conductive measuring samples.

Due to the electrical properties of TC sensors, it is important to ensure that a suitable type is selected for the required application temperature.

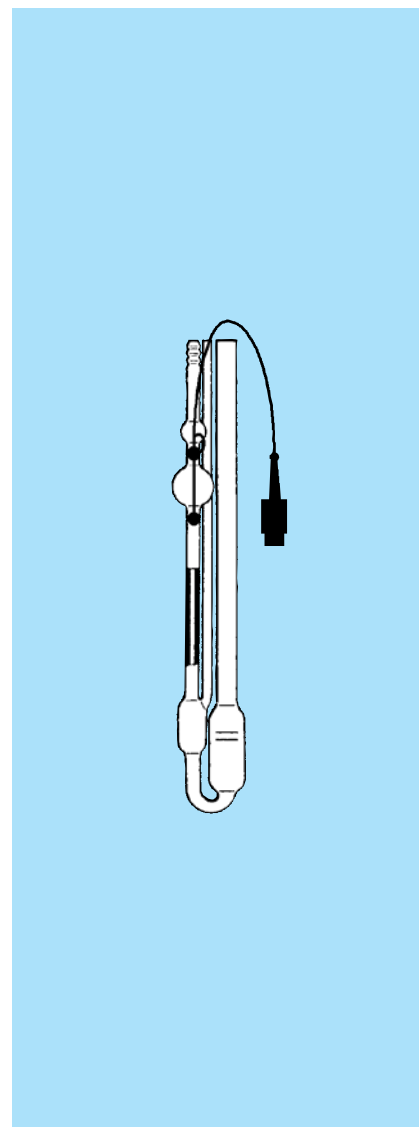

TC viscometers

- the technical measurement characteristics are in accordance with DIN 51 562, part 1, ISO 3105 (BS-IP-SL)
- for use in combination with an automatic viscosity measuring instrument
- filling quantity: 18 to 22 ml
- overall length: ca. 355 mm
- suitable bracket Type No. 05393, Order No. 285405035

calibrated,
with constant for automatic measurements

Type No.	Order No.	Type No.	Order No.	Type No.	Order No.	Capillary No.	Capillary Ø i [mm]	Constant K (approx.)	Measuring range [mm ² /s] (approx.)
+ 10 to + 80 °C		-40 to + 30 °C		+ 70 to + 150 °C					
567 03	285423420	-	-	-	-	0c	0.47	0.003	0.5 to 3
567 10	285423430	568 10	285423540	569 10	285423630	I	0.64	0.01	1.2 to 10
567 13	285423440	568 13	285423550	569 13	285423640	Ic	0.84	0.03	3 to 30
567 20	285423450	568 20	285423560	569 20	285423650	II	1.15	0.1	10 to 100
567 23	285423470	568 23	285423570	569 23	285423660	IIc	1.51	0.3	30 to 300
567 21	285423460	-	-	-	-	IIa	1.69	0.5	50 to 500
567 30	285423480	568 30	285423580	569 30	285423670	III	2.05	1	100 to 1,000
567 33	285423500	568 33	285423590	569 33	285423680	IIIc	2.7	3	300 to 3,000
567 31	285423490	-	-	-	-	IIIa	3.0	5	500 to 5,000
567 40	285423510	568 40	285423600	569 40	285423690	IV	3.7	10	1,000 to 10,000
567 43	285423530	568 43	285423620	569 43	285423700	IVc	4.9	30	3,000 to 20,000
567 41	285423520	568 41	285423610	-	-	IVa	5.3	50	5,000 to 30,000

Micro-Ubbelohde viscometers with TC sensors

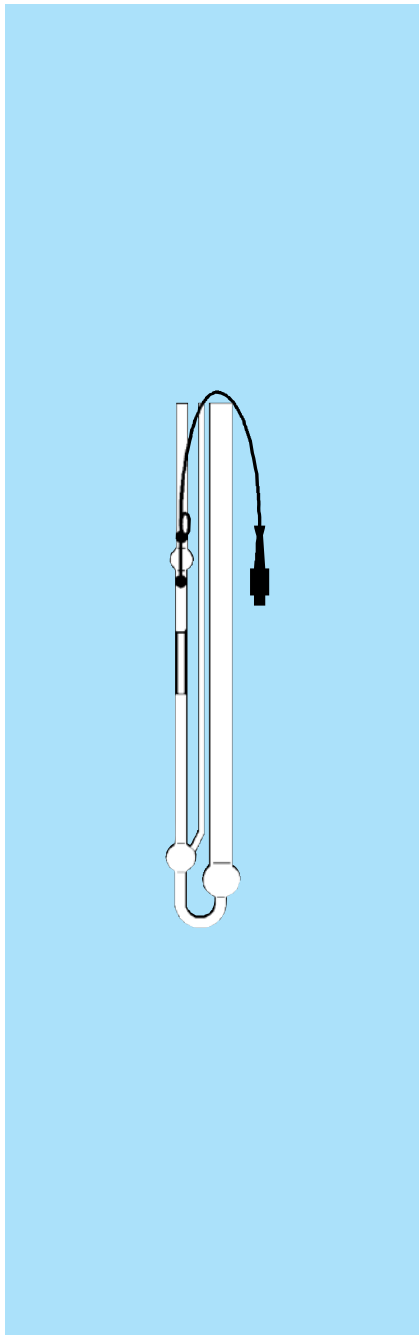

Viscometers with suspended level for determination of absolute and relative kinematic viscosity of liquids with Newtonian flow behaviour. The measuring levels are marked by TC sensors. The meniscus passage is detected due to the different conductivity of the liquid phase and the gas phase. A measurement stand of the type series AVS®/S is not required. TC viscometers can be used to determine the kinematic viscosity of all liquids with Newtonian flow behaviour.

They are especially suitable for liquids that cannot be detected with other systems: opaque and/or black and/or electrically conductive measuring samples.

Due to the electrical properties of TC sensors, it is important to ensure that a suitable type is selected for the required application temperature.

Micro TC viscometers

- the technical measurement characteristics are in accordance with DIN 51 562, Part 2
- for use in combination with an automatic viscosity measuring instrument
- filling quantity: 3 to 4 ml
- overall length: approx. 350 mm
- suitable bracket Type No. 05393, Order No. 285405035

not calibrated,
with constant for automatic measurements

Type No.	Order No.	Type No.	Order No.	Type No.	Order No.	Capillary No.	Capillary Ø i [mm]	Constant K (approx.)	Measuring range [mm ² /s] (approx.)
+ 10 to + 80 °C		- 40 to + 30 °C		+ 70 to + 150 °C					
572 10	285423710	573 10	285423780	574 10	285423850	M I	0.40	0.01	0.4 to 6
572 13	285423720	573 13	285423790	574 13	285423860	M Ic	0.53	0.03	1.2 to 18
572 20	285423730	573 20	285423800	574 20	285423870	M II	0.70	0.1	4 to 60
572 23	285423740	573 23	285423810	574 23	285423880	M IIc	0.95	0.3	12 to 180
572 30	285423750	573 30	285423820	574 30	285423890	M III	1.26	1	40 to 800

Micro-Ubbelohde viscometers

Viscometers for dilution viscometry

Viscometers with suspended level for determination of absolute and relative kinematic viscosity of liquids with Newtonian flow behavior. Due to their design, these viscometers are especially suitable for measurement of small liquid quantities and for particularly short running times. All viscometers are provided with ring marks. This ensures that viscometers for automatic measurements can also be checked by means of manual measurements.

Micro-Ubbelohde viscometers (DIN)

The calibrated viscometers are delivered with manufacturer's certificate in accordance with DIN 55 350, Part 18. For measurements with automatic viscosity measuring instruments, another constant is valid. This constant is determined by multiplication of the constant K with the correction factor F.

- in accordance with DIN 51562, Part 2
- filling quantity: 3 to 4 ml
- overall length: approx. 290 mm

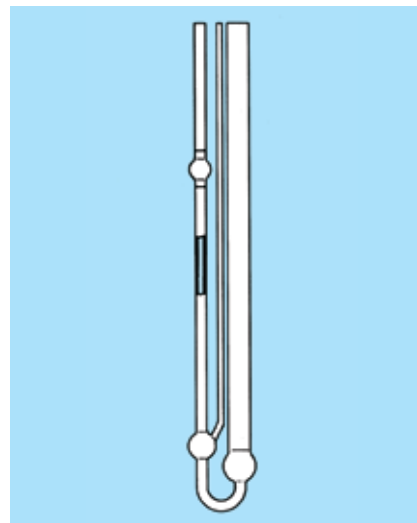

calibrated,
with constant for manual
measurement

calibrated,
with constant for
automatic measurement

not calibrated,
without constant;
for determination of
relative viscosity

Type No.	Order No.	Type No.	Order No.	Type No.	Order No.	Capillary No.	Capillary Ø i [mm]	Constant K (approx.)	Measuring range [mm ² /s] (approx.)
536 10	285401009	537 10	285401103	538 10	285401206	M I	0.40	0.01	0.4 to 6
536 13	285401017	537 13	285401111	538 13	285401214	M Ic	0.53	0.03	1.2 to 18
536 20	285401025	537 20	285401128	538 20	285401222	M II	0.70	0.1	4 to 60
536 23	285401033	537 23	285401136	538 23	285401239	M IIc	0.95	0.3	12 to 180
536 30	285401041	537 30	285401144	538 30	285401247	M III	1.26	1	40 to 800

Viscometers for dilution viscometry

Viscometers with suspended level designed according to the principle of the Ubbelohde viscometers for determination of the limit viscosity number of polymers. The limit viscosity number can be determined automatically in combination with one of

our piston burettes TITRONIC® 300 or TITRONIC® 500.

- filling quantity: 15 to 75 ml
- overall length: approx. 290 mm

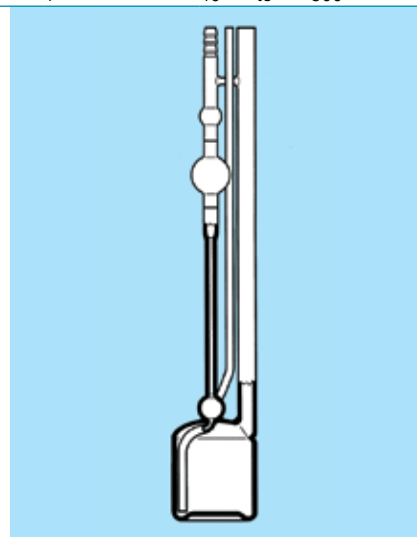

calibrated, for automatic measurements,
Model with glass filter on request

Type No.	Order No.	Capillary No.	Capillary Ø i [mm]	Constant K (approx.)	Measuring range [mm ² /s] (approx.)
531 00	285401403	0	0.36	0.001	0.35 to 0.6
531 03	285401428	0c	0.47	0.003	0.5 to 2
531 01	285401411	0a	0.53	0.005	0.8 to 3
531 10	285401436	I	0.64	0.01	1.2 to 6
531 13	285401444	Ic	0.84	0.03	3 to 20
531 20	285401452	II	1.15	0.1	10 to 60

Cannon-Fenske viscometers

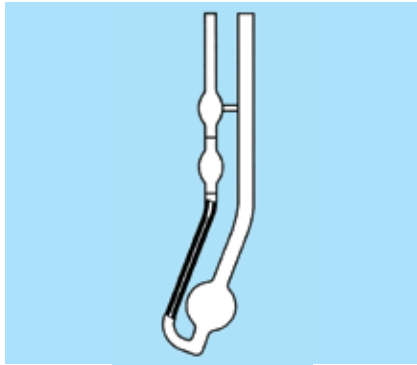

Cannon-Fenske routine viscometers

comply with standards ISO 3105, ASTM D 2515, BS 188 with respect to technical measuring specifications.

- are suitable for all Newtonian liquids with a viscosity of 0.35 to 20,000 mm²/s

- the present design has a deepening in the lower bend. Accordingly, these viscometers can also be used for automatic measurements.
- filling quantity: approx. 7 to 10 ml
- overall length: approx. 245 mm

calibrated,
with ring mark,
for manual measurements

with constant
for automatic measurements

Type No.	Order No.	Type No.	Order No.	Capillary No.	Capillary Ø i [mm]	Constant K (approx.)	Measuring range [mm ² /s] (approx.)
513 00	285403507	520 00	285403704	25	0.30	0.002	0.4 to 1.6
513 03	285403515	520 03	285403712	50	0.44	0.004	0.8 to 3.2
513 01	285403523	520 01	285403729	75	0.54	0.008	1.6 to 6.4
513 10	285403531	520 10	285403737	100	0.63	0.015	3 to 15
513 13	285403548	520 13	285403745	150	0.78	0.035	7 to 35
513 20	285403556	520 20	285403753	200	1.01	0.1	20 to 100
513 23	285403564	520 23	285403761	300	1.27	0.25	50 to 200
513 21	285403572	520 21	285403778	350	1.52	0.5	100 to 500
513 30	285403589	520 30	285403786	400	1.92	1.2	240 to 1,200
513 33	285403597	520 33	285403794	450	2.35	2.5	500 to 2,500
513 40	285403601	520 40	285403807	500	3.20	8	1,600 to 8,000
513 43	285403618	520 43	285403815	600	4.20	20	4,000 to 20,000

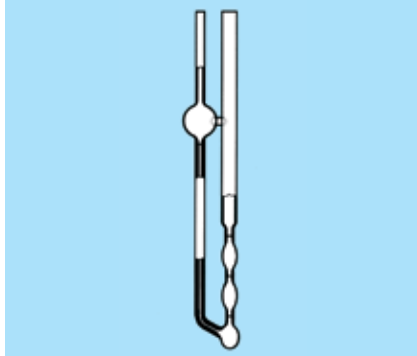

Cannon-Fenske reverse flow viscometers

- Comply with standards ISO 3105, ASTM D 2515, ASTM D 446, NF T 60 - 100 with respect to technical measuring specifications.

- filling quantity: approx. 12 ml
- overall length: approx. 295 mm

calibrated,
with 3 ring marks,
with 2 constants,
only for manual measurement

Type No.	Order No.	Capillary No.	Capillary Ø i [mm]	Constant K (approx.)	Measuring range [mm ² /s] (approx.)
511 00	285403001	25	0,31	0.002	0.4 to 1.6
511 03	285403018	50	0,42	0.004	0.8 to 3.2
511 01	285403026	75	0,54	0.008	1.6 to 6.4
511 10	285403034	100	0,63	0.015	3 to 15
511 13	285403042	150	0,78	0.035	7 to 35
511 20	285403059	200	1,02	0.1	20 to 100
511 23	285403067	300	1,26	0.25	50 to 200
511 21	285403075	350	1,48	0.5	100 to 500
511 30	285403083	400	1,88	1.2	240 to 1,200
511 33	285403091	450	2,20	2.5	500 to 2,500
511 40	285403104	500	3,10	8	1,600 to 8,000
511 43	285403112	600	4,00	20	4,000 to 20,000

Cannon-Fenske routine viscometers with additional tube and threads

comply with standards ISO 3105, ASTM D 2515, BS 188 with respect to technical measuring specifications. These viscometers are preferably used for automatic measurements. The additional filling and cleaning tube and the glass thread ensure safe operational use. The calibrated viscometers are delivered with manufacturer's certificate in accordance with DIN 55 350, Part 18.

- are suitable for all Newtonian liquids with a viscosity of 0.35 to 20,000 mm²/s.
- filling quantity: approx. 7 to 12 ml
- overall length: approx. 245 mm

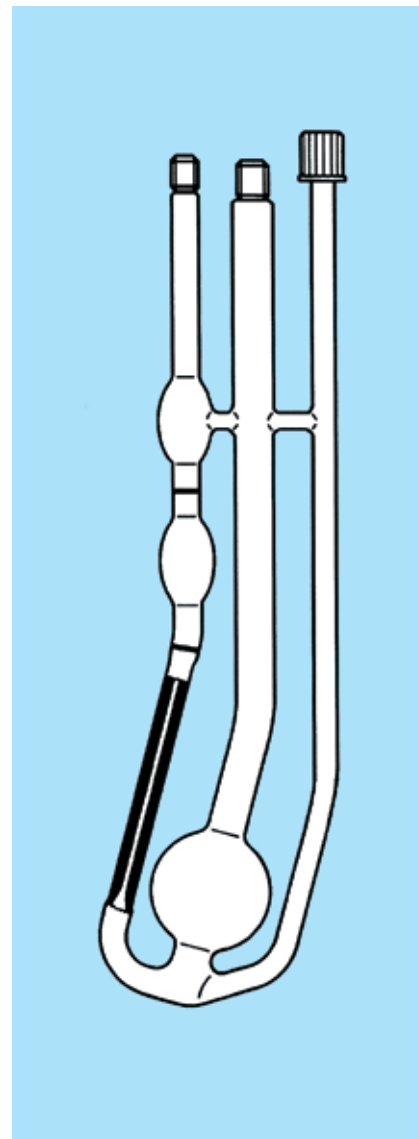

calibrated,
with ring marks,
with constant for automatic measurements

Type No.	Order No.	Capillary No.	Capillary Ø i [mm]	Constant K (approx.)	Measuring range [mm ² /s] (approx.)
546 00	285402116	25	0.30	0.002	0.4 to 1.6
546 03	285402132	50	0.44	0.004	0.8 to 3.2
546 01	285402124	75	0.54	0.008	1.6 to 6.4
546 10	285402149	100	0.63	0.015	3 to 15
546 13	285402157	150	0.78	0.035	7 to 35
546 20	285402165	200	1.01	0.1	20 to 100
546 23	285402181	300	1.27	0.25	50 to 200
546 21	285402173	350	1.52	0.5	100 to 500
546 30	285402198	400	1.92	1.2	240 to 1,200
546 33	285402202	450	2.35	2.5	500 to 2,500
546 40	285402219	500	3.20	8	1,600 to 8,000
546 43	285402227	600	4.20	20	4,000 to 20,000

Ostwald viscometers

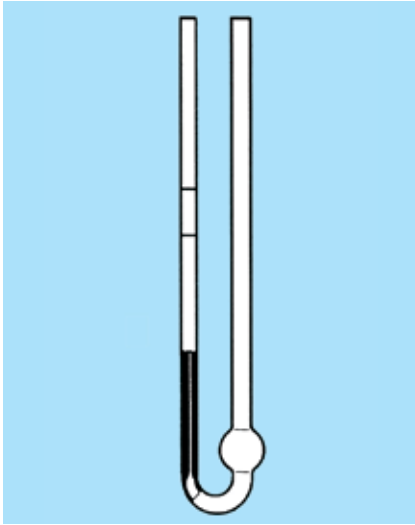

Ostwald viscometers

- filling quantity: 3 ml
- overall length: approx. 220 mm

with ring marks,
without constant,
for manual measurements

Type No.	Order No.	Capillary Ø i [mm]	Transit time for water ~ [s]	Constant K (approx.)	for use from [mm ² /s] (approx.)
509 03	285404006	0.3	250	0.004	0.3
509 04	285404014	0.4	75	0.01	1
509 05	285404022	0.5	30	0.03	2.5
509 06	285404039	0.6	15	0.07	5.5
509 07	285404047	0.7	10	0.1	10

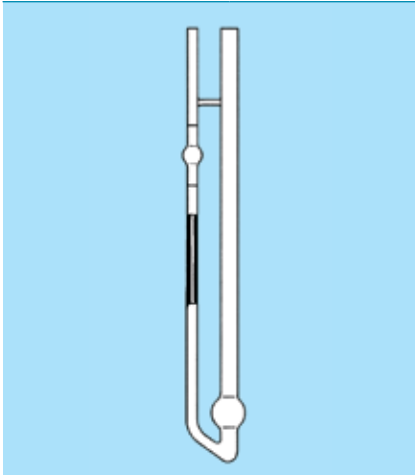

Micro-Ostwald viscometers

- are suitable for measurements of small liquid quantities even with excessive foam formation.
- filling quantity: 2 ml
- overall length: approx. 290 mm

calibrated,
with ring marks,
with constant,
for manual measurements

calibrated,
with ring marks,
with constant,
for automatic measurements

not calibrated,
without constant;
for determination of relative viscosity

Type No.	Order No.	Type No.	Order No.	Typ-Nr.	Bestell-Nr.	Capillary No.	Capillary Ø i [mm]	Constant K (approx.)	Measuring range [mm ² /s] (approx.)
516 10	285404203	517 10	285404306	518 10	285404409	I	0.43	0.01	0.4 to 6
516 13	285404211	517 13	285404314	518 13	285404417	Ic	0.60	0.03	1.2 to 18
516 20	285404228	517 20	285404322	518 20	285404425	II	0.77	0.1	4 to 60
516 23	285404236	517 23	285404339	518 23	285404433	IIc	1.00	0.3	12 to 180
516 30	285404244	517 30	285404347	518 30	285404441	III	1.36	1	40 to 800

Accessories

Brackets and stands

All brackets and stands are designed to ensure that the viscometers are held vertically. They also protect the viscometers from breakage. The maximum deviation is $< 1^\circ$. In conjunction with SI Analytics and other commercially available seethrough thermo-

stats the viscometers can only be used with the appropriate stand or bracket.

For DIN Ubbelohde viscometers that are used as reference measuring standard, specifically modified bracket (VZ 5840) must be used.

Brackets made of stainless steel suitable for use with all Ubbelohde viscometers for manual and automatic measurements

Type No.	Order No.
053 92	285405043
VZ 5840 (accessory for reference measuring standard)	285417201

suitable for use with Ubbelohde viscometers with TC sensors

Type No.	Order No.
053 93	285405035

suitable for use with all reverse flow viscometers (Cannon-Fenske and BS/IP U-tube viscometers) for manual and automatic measurements (not illustrated)

Type No.	Order No.
053 96	285405019

suitable for use with Micro-Ostwald viscometers for manual and automatic measurements

Type No.	Order No.
053 97	285405027

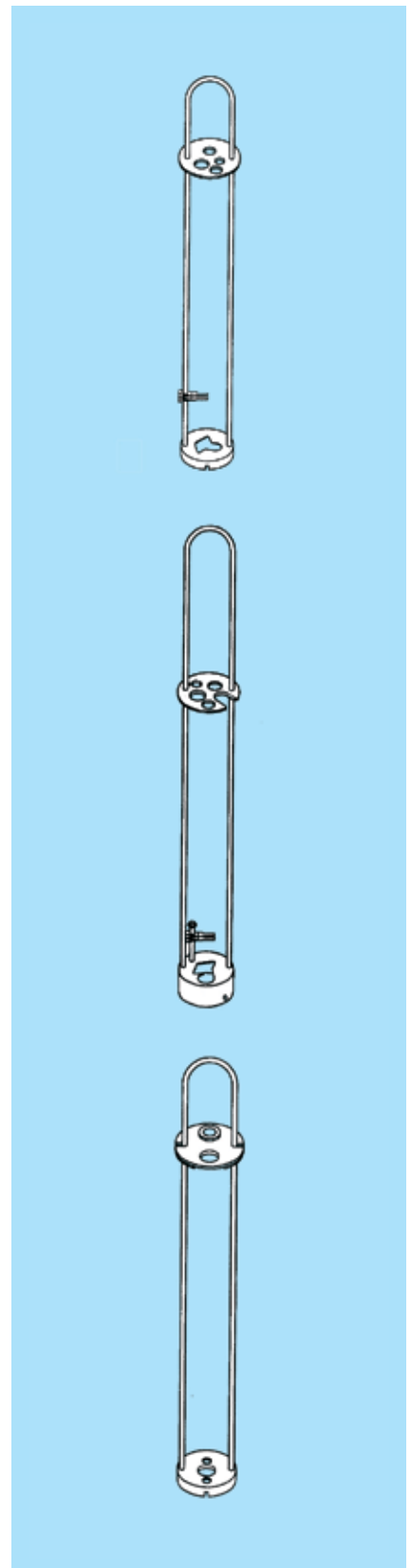

Accessories



Brackets for reference measuring standard

DIN Ubbelohde viscometers which are used as testing standard should be stored in a specially modified viscometer bracket according to official inspection / calibration authorities.

The extension set for the test standard (VZ 5840) as supplement to the bracket guarantees vertical slope with a maximum deviation of $< 1^\circ$ and the centered positioning of the capillaries.

Type No.	Order No.
VZ 5840	285417201

Control thermometers

Type No.	Order No.	Measuring range °C	Graduation °C
VZ 2801	285415763	-5 to +38	1/10
VZ 2802	285415771	+33 to +67	1/10
VZ 2803	285415788	+66 to +102	1/10
VZ 2804	285415796	+95 to +152	1/10
VZ 2901	285415809	+20 to +25	1/100
VZ 2907	285417078	+22 to +27	1/100
VZ 2908	285415825	+37 to +42	1/100
VZ 2905	285415841	+45 to +50	1/100
VZ 2906	285415858	+97 to +101	1/100
VZ 2909	285417094	+132 to +137	1/100

Control thermometers for CT 72 thermostat series

Type No.	Order No.	Measuring range °C	Graduation °C
VZ 7100	285421051	+19 to +21	1/100
VZ 7101	285421068	+24 to +26	1/100
VZ 7102	285421076	+29 to +31	1/100
VZ 7103	285421084	+39 to +41	1/100
VZ 7104	285421092	+99 to +101	1/100
VZ 7105	285421105	+134 to +136	1/100

Accessories

LabPump

The LabPump VZ 5655 (not illustrated) used with manual and semi-automatic measurements to extract and pump solutions:

- filling of viscometers
- rinsing with the next sample
- extract between manual measurements
- emptying of viscometers without removing them from the thermostatic bath

Since the LabPump VZ 5655 and the connections are made of PTFE or stainless steel, the pump is suitable for use with aggressive mediums.

The range of use for semi-automatic processing of samples, e.g. with a viscosity measuring instrument AVS® 360, AVS® 370 or AVS® 470, is possible up to a viscosity of 30,000 mm²/s. For semi-automatic processing work, the PTFE tube combination with stand (see illustration) and the waste bottle, type no. VZ 5624, are used.

Type No.	Order No.
VZ 5655	1040755

Polyamide bracket

for use with Cannon-Fenske routine viscometers, Cannon-Fenske reverse flow viscometers and all Ostwald viscometers for manual measurements only

Type No.	Order No.
064 99	285405105

PTFE bracket

for use with Cannon-Fenske routine viscometers, for automatic measurements only (not illustrated)

Type No.	Order No.
065 99	285405113

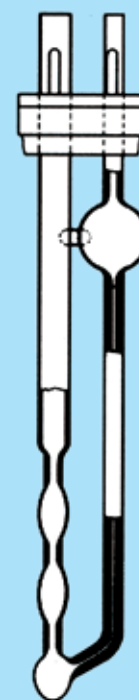

Accessories

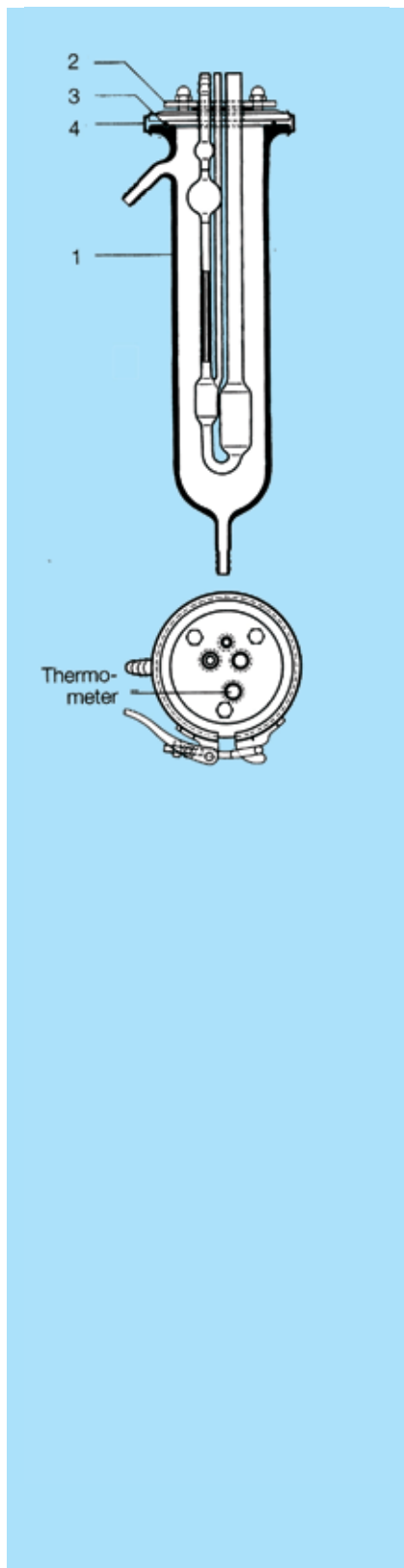

Temperature stabilization jackets

In the absence of a see-through thermostat the temperature of capillary viscometers can be stabilized in this type of jacket using circulation thermostats in the temperature range 0 to 180 °C. The shape of the jacket and the number of holes in the support

plate depend upon the type of viscometer being used. The support plate has been designed to facilitate changing the viscometer when required. An additional hole is provided in the support plate so that a control thermometer can be fitted. A quick-action seal simplifies changing viscometers.

Temperature stabilization jacket with support plate for Ubbelohde viscometers

Type No.	Order No.	Item No.	Comment
577 00	285405508		complete, without viscometer
Component parts			
577 01	285405516	1	temperature stabilization jacket, straight
238 00	285405524	2	support plate with 4 silicone rings (d = 4, 6, 8 and 10 mm)
225 34	285405532	3	silicone O-ring, ND 60
072 34	285405549	4	quick-action seal, NW 60

Silicone rings

Type No.	Order No.	d mm	D mm	h mm
228 11	285405808	4	10	5
228 14	285405816	6	16	5
228 16	285405824	8	16	5
228 17	285405832	10	16	5

Accessories

Accessories

Filtration system ProClean II

For filtration of solutions in viscometry. All standard solutions can be filtrated, also with aggressive solvents used in polymer analytics. The system is configured for 100ml screw neck bottles GL 45. The solutions are filtrated by using wire-mesh filters made of Hastelloy, fixed on a holder by a screw cap. The sample solutions are filtrated by sucking through the wire mesh by using disposable syringes with luer-fitting (e.g. 20ml, not in scope of supply). As filtration is done by suction, there is no risk of splashing - important for filtration of dangerous liquids. After use, the filter blanks can be cleaned and reused.

The single components of the filtration system can be ordered separately.

Type No.	Order No.	Article	Description
VZ 7090	285422500	Filtration system ProClean II, Set-5	5x sample bottles with screw caps and filter holders; filter blanks (Hastelloy) 20µm and 30µm mesh size (10pcs. per set)
VZ 7092	285422470	Filter holder for ProClean II	5 pcs.
VZ 7093	285422510	Screw caps for ProClean II	For fixing of filters, 10 pcs.
VZ 7094	285422480	Filter 20µm mesh size	Hastelloy C4, 10 pcs.
VZ 7095	285422520	Filter 30µm mesh size	Hastelloy C4, 10 pcs.
VZ 7096	285422490	Bottle set for ProClean II	5x sample bottles with screw caps (with and without bore hole)



ories

AVS[®] measuring stands

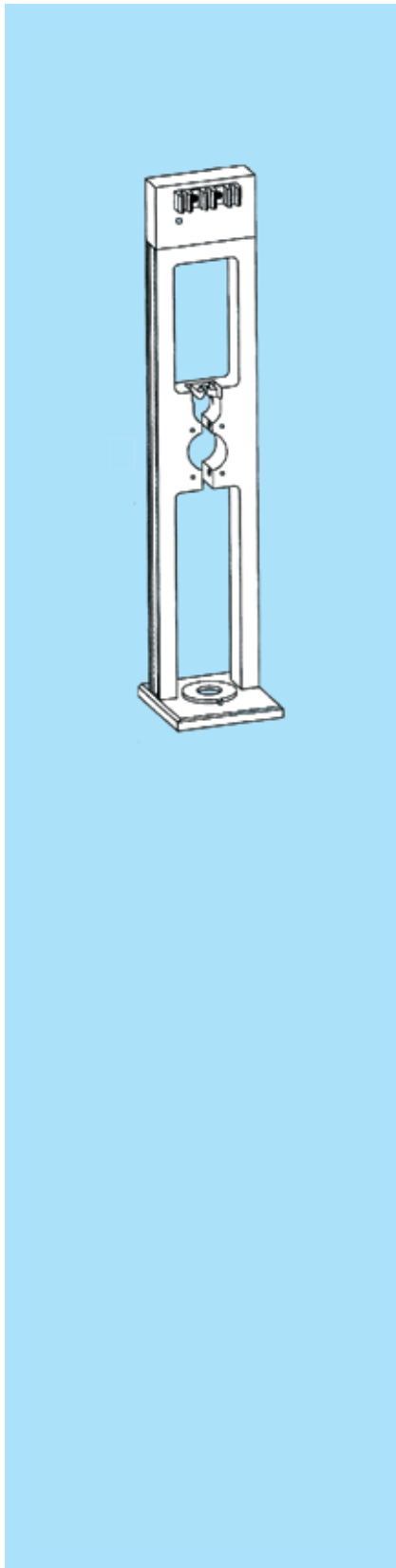

AVS[®] measuring stands

Measuring stands of the series AVS[®]/S can be used to measure the flow-through time in viscometers automatically.

The measuring stands can be connected to all measuring instruments made by SI Analytics for automatic measurement of viscosity and operate with all standard viscometers for repetitive measurements.

Automatic measurements have the following advantages:

- the repetitive standard deviation is less than for manual measurements
- the measurement is free from subjective factors of influence
- the results can be printed and/or be automatically documented with a data memory system
- automatic processing of sample series is available.

The use of different materials ensures adaptation to existing measurement temperatures and applications.

The measuring stands or brackets can be exchanged.

The distance between the levels of the automatic optoelectronic unloading system is 40.00 mm \pm 0.03 mm. This results in a standard deviation of VK=0.05% for Ubbelohde viscometers if the measuring stand is replaced or changed within the process.

For repetitive measurements with viscosity measuring instruments and Ubbelohde viscometers with measuring stands, the standard deviation VK=0.03%.

Manually calibrated Ubbelohde viscometers can also be used in AVS[®] measuring stands. If the automatic sensing levels do not correspond to the ring marks, the superimposed meniscus detection system will provide a higher constant. The difference amounts to 0.1% per millimeter of height offset.

Measuring stands

	AVS®/S	AVS®/S-HT	AVS®/SK	AVS®/S-CF	AVS®/SK-V
Available viscometers	Ubbelohde viscometers in accordance with DIN, ASTM, ISO 3105, Micro-Ubbelohde viscometers, Micro-Ostwald viscometers			Cannon-Fenske-routine viscometer	Ubbelohde-dilution viscometer
Temperature range	-80 to +100 °C	-80 to +200 °C	0 to +60 °C	-80 to +100 °C	0 to +60 °C other temperature ranges available on request
Suitable brackets (type no.)	05392 05397			no bracket required	
Material	Aluminium, TiO ₂ -anodized		PVDF, stainless steel	Aluminium, TiO ₂ -anodized	PVDF, stainless steel
Dimensions (W x H x D) mm	90 x 447 x 90	90 x 496 x 90	90 x 447 x 90	90 x 447 x 90	90 x 447 x 90
Weight (kg) appr.	1.0	1.25	0.8	1.0	0.8
Accessories included in scope of delivery	Bracket Type No. 05392 for Ubbelohde viscometers, tube/cable combination VZ 5505			tube/cable combination VZ 5505	tube/cable combination VZ 5857, magnetic stirring rods, fastening springs for viscometer

Note:

When TC viscometers are being used, a bracket type no. 05393, with the necessary tube set is required only. A measuring stand is not required.

Suitable for use with the measuring units: AVS® 350, AVS® 360, AVS® 370, AVS® 450, AVS® 470, AVS®Pro

Suitable for use with the thermostatic baths: CT 72/P, CT 72/2-TT, CT 72/2, CT 72/4

Electrical connection: Cable VZ 6225 for all measuring stands to all instruments (is included in hose sets VZ 5505, VZ 5622 and VZ 5857), control lamp as function display

Distance between measuring levels: 40.00 mm ± 0.03 mm at 25 °C

Signal transmission: Optically using optical fibres from the measuring level in the stand head, converted into analogue signal from stand to measuring instrument

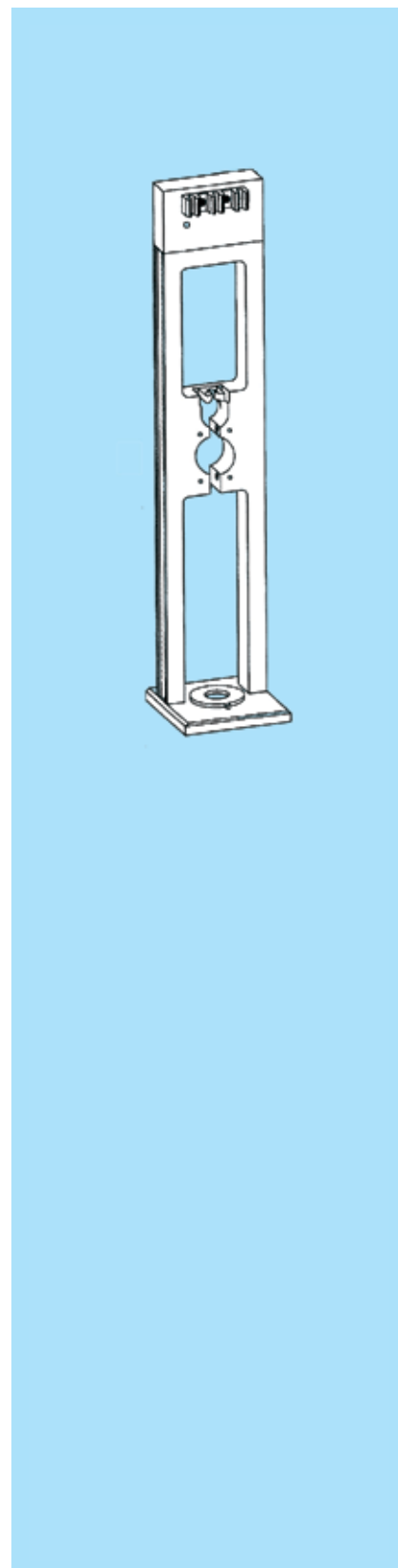

What can Xylem do for you?

We're 12,700 people unified in a common purpose: creating innovative solutions to meet our world's water needs. Developing new technologies that will improve the way water is used, conserved, and re-used in the future is central to our work. We move, treat, analyze, and return water to the environment, and we help people use water efficiently, in their homes, buildings, factories and farms. In more than 150 countries, we have strong, long-standing relationships with customers who know us for our powerful combination of leading product brands and applications expertise, backed by a legacy of innovation.

For more information on how Xylem can help you, go to www.xylem.com

SI Analytics
a xylem brand

SI Analytics GmbH

Hattenbergstrasse 10
55122 Mainz
Germany

Phone: +49.(0)6131.66.5111
Fax: +49.(0)6131.66.5001
E-Mail: si-analytics@xylem.com
Internet: www.si-analytics.com

presented by

SI Analytics is a trademark of Xylem Inc. or one of its subsidiaries. ©
2018 Xylem, Inc. 980 087US Version 04/2018

