

Additional Installation, Operation and  
Maintenance Instructions



# e-LNE, e-LNT hydrovar X Series

Pump unit with integrated variable speed drive

LNEEX, LNEEK, LNESX, LNESK

LNTEX, LNTEK, LNTSX, LNTSK

# Table of Contents

- 1 Introduction and Safety ..... 5
  - 1.1 Introduction ..... 5
  - 1.2 Hazard levels and safety symbols..... 5
  - 1.3 User safety ..... 7
  - 1.4 Protection of the environment..... 7
- 2 Handling and Storage..... 8
  - 2.1 Unit inspection upon delivery..... 8
    - 2.1.1 Package inspection ..... 8
    - 2.1.2 Unpacking and inspection of the unit ..... 8
  - 2.2 Guidelines for transport..... 8
    - 2.2.1 Handling of the packed unit using a forklift truck..... 9
    - 2.2.2 Lifting with a crane ..... 9
  - 2.3 Storage ..... 11
- 3 Product Description ..... 12
  - 3.1 Features ..... 12
    - 3.1.1 Use in water distribution networks for human consumption ..... 12
    - 3.1.2 Part names ..... 13
  - 3.2 Data plate ..... 15
  - 3.3 Identification code ..... 15
  - 3.4 Approval marks ..... 15
- 4 Installation ..... 16
  - 4.1 Precautions ..... 16
  - 4.2 Mechanical installation..... 17
    - 4.2.1 Permitted positions ..... 17
    - 4.2.2 Installation area ..... 18
    - 4.2.3 Requirements on the concrete foundation ..... 18
    - 4.2.4 Support kit ..... 19
    - 4.2.5 Anchoring to the floor..... 22
    - 4.2.6 Reducing vibrations ..... 22
  - 4.3 Hydraulic connection ..... 22
    - 4.3.1 Loads applicable to the flanges..... 23
  - 4.4 Guidelines for electrical connection..... 24
  - 4.5 Guidelines for the control panel..... 25
    - 4.5.1 Fuses and/or automatic switches ..... 25
    - 4.5.2 Ground fault circuit interrupter, GFCI ..... 26
  - 4.6 Guidelines for the drive ..... 26
    - 4.6.1 Orientation of the drive display..... 26
    - 4.6.2 Power supply connection..... 27

5	Use and Operation.....	29
5.1	Precautions .....	29
5.2	Filling and priming .....	30
5.3	Startup .....	30
5.4	Manual stop .....	31
6	Control.....	32
6.1	LN..X drive display .....	32
6.1.1	Graphic display.....	33
6.1.2	Parameter menu, LN..X .....	34
6.1.3	LN..X unit start .....	34
6.1.4	Operating mode change, LN..X.....	34
6.1.5	Error reset, LN..X .....	35
6.2	LN..K drive display .....	35
6.2.1	Main visualization .....	37
6.2.2	Parameter menu, LN..K .....	37
6.2.3	LN..K unit start .....	38
6.2.4	Operating mode change, LN..K.....	38
6.2.5	Error reset, LN..K .....	38
6.3	Xylem X App.....	38
7	Maintenance.....	40
7.1	Precautions .....	40
7.2	Maintenance every 4000 hours of operation, or every year .....	41
7.3	Maintenance every 10000 hours of operation or every 2 years .....	41
7.4	Maintenance every 17500 hours of operation or every 5 years .....	41
7.5	Blind flanges for e-LNT models .....	41
7.6	Long periods of inactivity.....	42
7.7	Tightening torques of the threaded connections .....	42
7.8	Identification of spare parts .....	42
8	Troubleshooting.....	43
8.1	The unit does not switch on .....	43
8.2	Little or no hydraulic performance .....	43
8.3	Non-powered unit runs in reverse (e-LNT models) .....	44
8.4	The differential protection device (RCD) has tripped .....	44
8.5	The unit produces excessive noise and/or vibrations .....	44
8.6	The unit is leaking at the mechanical seal.....	44
8.7	Unit error or alarm.....	44
9	Specifications .....	45
9.1	Operating environment .....	45
9.2	Maximum operating pressure .....	45
9.3	Maximum number of starts and stops.....	46
9.4	Electrical specifications .....	46
9.5	Radio frequency characteristics.....	46

9.6	Characteristics of inputs and outputs .....	46
9.7	Sound pressure .....	47
9.8	Materials in contact with the liquid .....	47
9.9	Mechanical seal .....	47
10	Disposal .....	48
10.1	Precautions .....	48
10.2	WEEE (EU/EEA) .....	48
10.3	WEEE (UK) .....	48
11	Declarations.....	49
11.1	EC Declaration of Conformity (Original) .....	49
11.2	UK Declaration of Conformity (Original).....	50
12	Warranty .....	53

# 1 Introduction and Safety

## 1.1 Introduction

### Purpose of this manual

This manual provides information on how to do the following in the correct manner:

- Installation
- Operation
- Maintenance.

### Supplementary instructions



The instructions and warnings of this manual apply to the standard unit as described in the sale documentation. Special version pumps may be supplied with supplementary instruction manuals. For situations not considered in the manual or in the commercial documentation, contact Xylem or the Authorised Distributor.

## 1.2 Hazard levels and safety symbols











Before using the unit, the user must read, understand and comply with the indications of the danger warnings in order to avoid the following risks:

- Injuries and health hazards
- Damage to the product
- Unit malfunction.

### Hazard levels

Hazard level	Indication
 <b>DANGER:</b>	It identifies a dangerous situation which, if not avoided, causes serious injury, or even death.
 <b>WARNING:</b>	It identifies a dangerous situation which, if not avoided, may cause serious injury, or even death.
 <b>ATTENTION:</b>	It identifies a dangerous situation which, if not avoided, may cause small or medium level injuries.
<b>NOTE:</b>	It identifies a situation which, if not avoided, may cause damage to property but not to people.

Complementary symbols

Symbol	Description
	Electrical hazard
	Hot surface hazard
	Danger, pressurized system
	Explosive atmosphere hazard
	Ionizing radiation hazard
	Danger, suspended loads
	Magnetic hazard
	Do not use flammable liquids
	Do not use corrosive liquids
	Obligation to read the instruction manual
	Obligation to wear safety shoes
	Obligation to wear safety glasses
	Obligation to wear a safety helmet
	Obligation to wear safety gloves

## 1.3 User safety

Strictly comply with current health and safety regulations.

### Qualified personnel

This unit must be used only by qualified users. Qualified users are people able to recognise the risks and avoid hazards during installation, use and maintenance of the unit.

## 1.4 Protection of the environment

### Disposal of packaging and product

Comply with the current regulations on sorted waste disposal.

### Leaking of fluid

If the unit contains lubricating fluid, take appropriate measures to prevent the dispersion of leaks into the environment.

### Sites exposed to ionizing radiations



---

#### **WARNING: Ionizing radiation hazard**

If the unit has been exposed to ionizing radiations, implement the necessary safety measures for the protection of people. If the unit needs to be dispatched, inform the carrier and the recipient accordingly, so that appropriate safety measures can be put in place.

---

# 2 Handling and Storage

## 2.1 Unit inspection upon delivery

### 2.1.1 Package inspection

1. Check that quantity, descriptions and product codes match the order.
2. Check the packaging for any damage or missing components.
3. In case of immediately detectable damage or missing parts:
  - Accept the goods with reserve, indicating any findings on the transport document, or
  - Reject the goods, indicating the reason on the transport document.In both cases, promptly contact Xylem or the Authorised Distributor from whom the product was purchased.

### 2.1.2 Unpacking and inspection of the unit



---

**ATTENTION: Cut and abrasion hazard**  
Always wear personal protective equipment.

---

1. Remove the packaging.
2. Ensure sorting of all packaging materials in accordance with the applicable regulations.
3. Release the unit by removing the screws and/or cutting the straps, if fitted.
4. Check the unit for integrity and to make sure that there are no missing components.
5. In case of damage or missing components, promptly contact Xylem or the Authorised Distributor.

## 2.2 Guidelines for transport

### Precautions



---

**WARNING: Crushing hazard**  
The unit and components are heavy: risk of crushing.

---



---

**WARNING:**  
Always wear personal protective equipment.

---



---

**WARNING:**  
Check the gross weight marked on the packaging.

---



---

**WARNING:**  
Handle the unit in compliance with the current regulations on "manual load handling", to avoid undesirable ergonomic conditions causing risks of back-spine injury.

---



---

**WARNING:**  
Take appropriate measures during transport, installation and storage to prevent contamination from external substances.

---



## 2.2.1 Handling of the packed unit using a forklift truck

The Figure shows the types of packaging depending on the sizes of the unit and the lifting points.

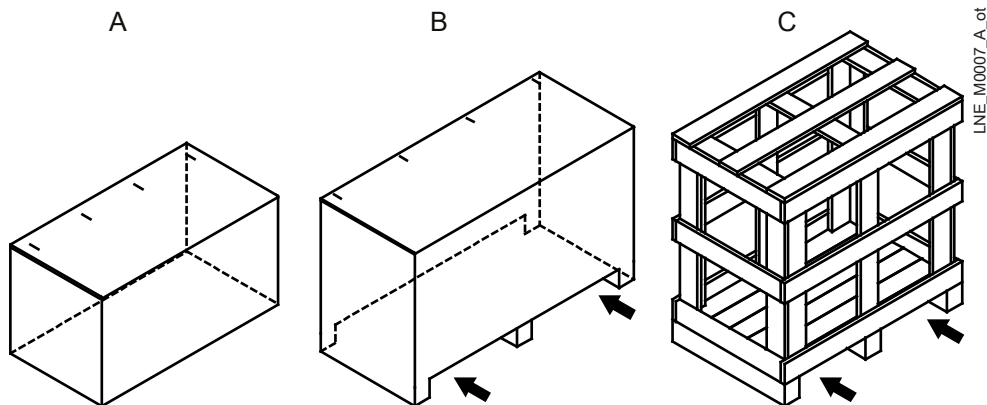

## 2.2.2 Lifting with a crane



**WARNING:**

Use ropes, chains and/or slings (hereinafter referred to as "ropes"), hooks and/or clasps (hereinafter referred to as "hooks"), shackles or eyebolts that comply with the applicable directives and are suitable for use.

**NOTE:**

Make sure that the harnessing does not hit and/or damage the unit.



**WARNING:**

Lift and handle the unit slowly to avoid stability issues.



**WARNING:**

During handling, make sure to avoid injury to people and animals, and/or damage to property.



**WARNING:**

Do not use eyebolts screwed on the motor for lifting the unit.

Move the unit from the horizontal to the vertical position, using the motor eyebolts only if necessary, fixing the ropes to a sling bar.

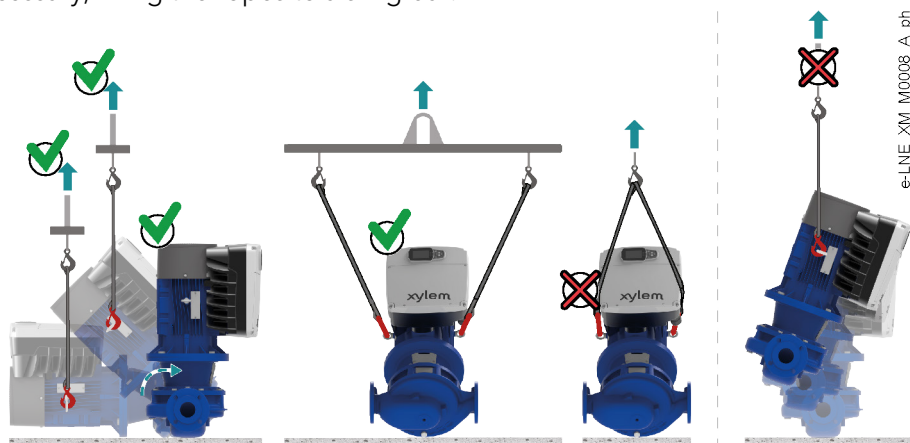

The figure shows how to harness and lift e-LNE and e-LNT units.

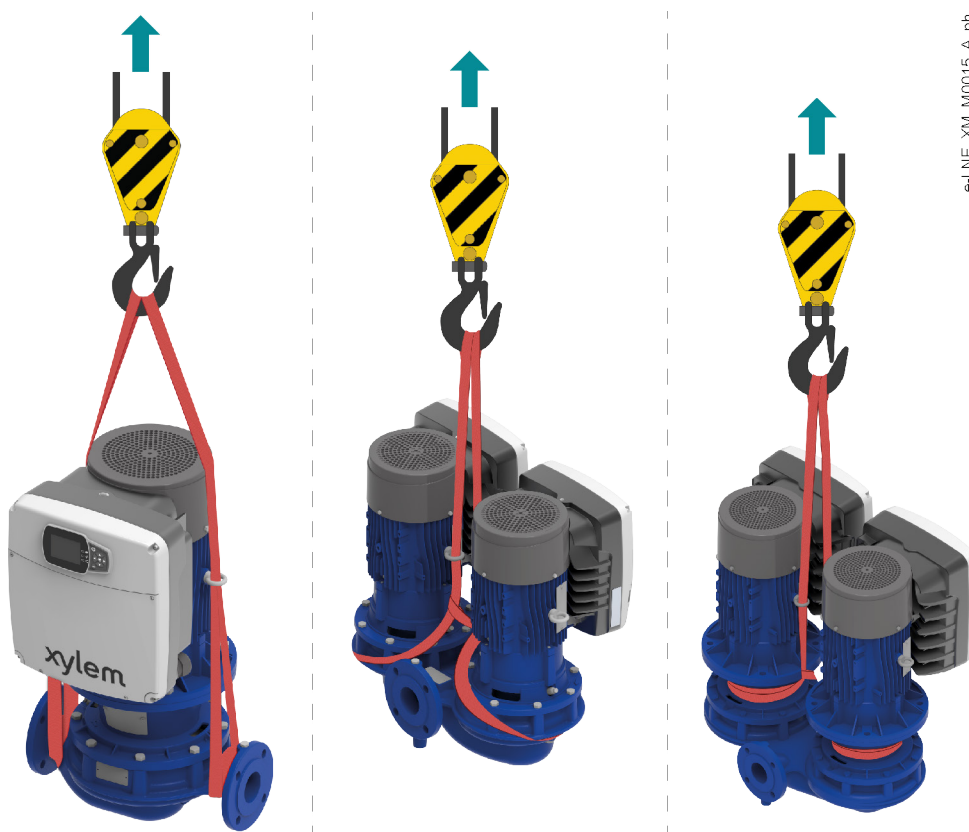

## 2.3 Storage

### Storage of the packed unit

The unit must be stored:

- In a covered and dry place
- Away from heat sources
- Protected from dirt
- Protected from vibrations
- At an ambient temperature between -5°C and 40°C (23°F and 104°F), and maximum relative humidity of 90% at 30°C (86°F).

---

**NOTE:**

Do not place heavy loads on top of the unit.

---

**NOTE:**

Protect the unit from collisions.

---

### Long-term storage of the installed unit

1. Empty the unit by removing the drain plug.

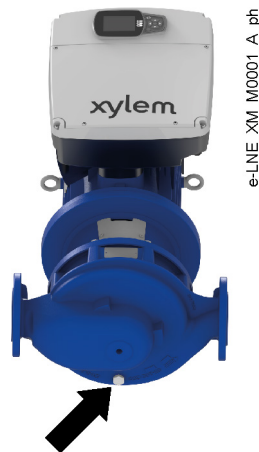

This operation is essential in environments with cold temperatures. Otherwise, any residual liquid in the unit could have an adverse effect on its condition and performance.

2. Follow the same instructions for the storage of the packed unit.

For more information on long-term storage contact the Xylem sales company or Authorised Distributor.

# 3 Product Description

## 3.1 Features

The product is a centrifugal pump unit with in-line suction and discharge flanges (hereafter 'unit') and integrated variable speed drive.

### Denomination of the models

Model	Description
LNEEX, LNEEK	Single-impeller, close-coupled with an impeller keyed directly to the motor shaft extension.
LNESX, LNESK	Single-impeller, rigid-coupled with a rigid coupling keyed to the standard motor shaft extension.
LNTEX, LNTEK	Double volute, flap valve, close-coupled with an impeller keyed directly to the special motor shaft extension.
LNTSX, LNTSK	Double volute, flap valve, rigid-coupled with a rigid coupling keyed to the standard motor shaft extension.

### Intended use

- HVAC, Liquid transfer in the following systems:
  - Heating
  - Conditioning
  - Ventilation.
- Water supply:
  - Pressure boosting in commercial buildings
  - Irrigation systems
  - Water transfer for green houses.

Observe the operating limits in **Specifications** on page 45.



---

**DANGER: Potentially explosive atmosphere hazard**

It is prohibited to start the unit in environments with potentially explosive atmospheres or with combustible dusts.

---

### Pumped liquids

- Clean
- Chemically and mechanically non aggressive
- Refrigerants
- Hot water
- Cold water.



---

**DANGER:**

It is prohibited to use this unit to pump flammable and/or explosive liquids.

---

### 3.1.1 Use in water distribution networks for human consumption

If the unit is intended for water supply to people and/or animals:



---

**WARNING:**

It is prohibited to pump drinking water after use with other fluids.

---



**WARNING:**

Take appropriate measures during transport, installation and storage to prevent contamination from external substances.



**WARNING:**

Remove the unit from its packaging just before installation to prevent contamination from external substances.



**WARNING:**

After installation, run the unit for a few minutes with several users open in order to wash the inside of the system.

### 3.1.2 Part names

e-LNE

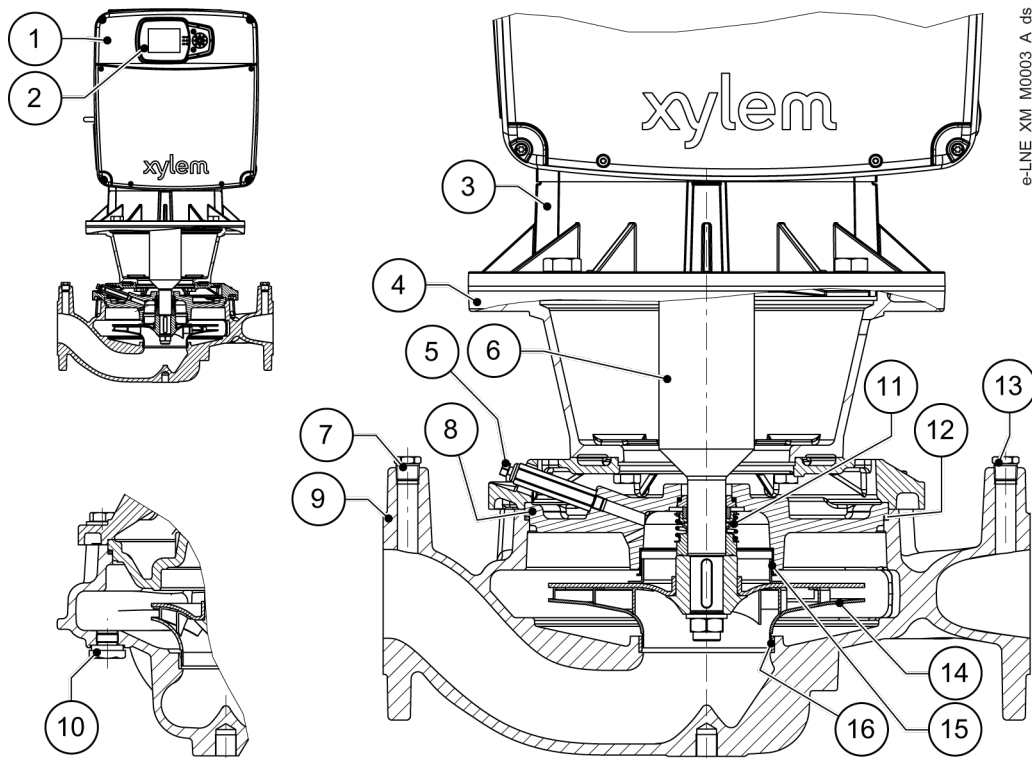

- 1. Drive
- 2. Drive display
- 3. Motor
- 4. Motor adapter
- 5. Bleed valve
- 6. Shaft
- 7. Cap
- 8. Seal housing
- 9. Pump body
- 10. Drain plug
- 11. Mechanical seal
- 12. O-Ring
- 13. Cap
- 14. Impeller
- 15. Wear ring
- 16. Wear ring

e-LNT

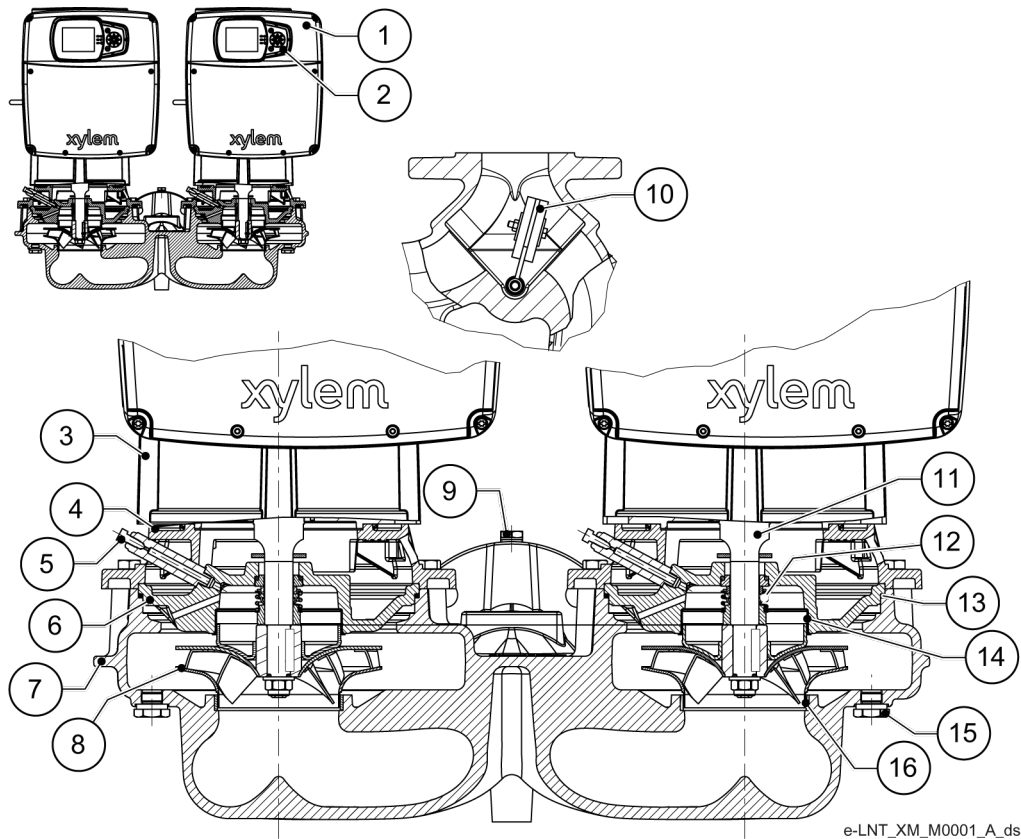

e-LNT\_XM\_M0001\_A\_ds

1. Drive
2. Drive display
3. Motor
4. Adapter
5. Bleed valve
6. Seal housing
7. Pump body
8. Impeller
9. Cap
10. Flap valve
11. Shaft
12. Mechanical seal
13. O-Ring
14. Wear ring
15. Drain plug
16. Wear ring

## 3.2 Data plate

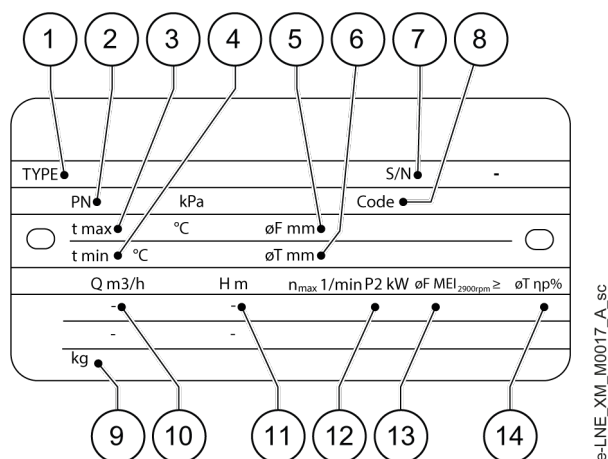

1. Pump unit type
2. Maximum operating pressure
3. Maximum liquid operating temperature
4. Minimum liquid operating temperature
5. Rated impeller diameter
6. Impeller diameter (trimmed impellers only)
7. Serial number + manufacturing date
8. Product code
9. Weight
10. Flow rate range
11. Head range
12. Pump rated power
13. Minimum efficiency index
14. Hydraulic efficiency in best efficiency point

## 3.3 Identification code

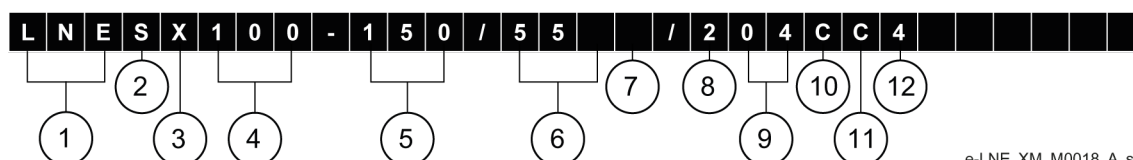

1. Series name
2. Close-coupled [E] or rigid [S] coupling
3. Hydrovar X+ [X] or hydrovar X [K]
4. Flange diam in mm
5. Maximum head in mm x 10
6. Rated power in kW x 10
7. Standard impeller [ ] with reduced average diameter at the same rated power [A] [B] [C] or with reduced average diameter adapted to the duty point requested by the customer [X]
8. High [2] or low [4] speed
9. Power supply voltage 3x200-240 V [03] or 3x380-480 V [04]
10. Pump body in cast iron [C]
11. Cast iron [C], stainless steel [S], bronze [B] or stainless steel 1.4408 [N] impeller
12. Mechanical seal and elastomers; see the technical catalogue

## 3.4 Approval marks

Any electric safety approval marks found only apply to the pump unit.

# 4 Installation

## 4.1 Precautions

### General precautions

Before starting, make sure that the safety instructions shown in **Introduction and Safety** on page 5 have been fully read and understood.



---

**DANGER:**

All the hydraulic and electrical connections must be completed by a technician possessing the technical-professional requirements outlined in the current regulations.

---

---



---

**WARNING:**

Always wear personal protective equipment.

---

---



---

**WARNING:**

Always use suitable working tools.

---

---



---

**WARNING:**

When selecting the place of installation and connecting the unit to the hydraulic and electric power supplies, strictly comply with current regulations.

---

---

When connecting the unit to a public or private aqueduct, or to a well for the supply of water for human and/or animal consumption, see **Use in water distribution networks for human consumption** on page 12.

---

---



---

**WARNING:**

Piping must be sized to ensure safety at the maximum operating pressure.

---

---



---

**WARNING:**

Install appropriate gaskets between the unit and the piping system.

---

---

### Electrical measures



---

**DANGER: Electrical hazard**

Before starting work, check that the electric power supply is disconnected and locked out, to avoid unintentional restart of the unit, the control panel and the auxiliary control circuit.

---

---

---

**NOTE:**

The mains voltage and frequency must match the values indicated on the motor data plate.

---

---





## 4.2.2 Installation area

1. Follow the provisions in **Operating environment** on page 45.
2. In case of outdoor installation, ensure appropriate protection of the unit against direct sunlight, rain and snow using appropriate covers.

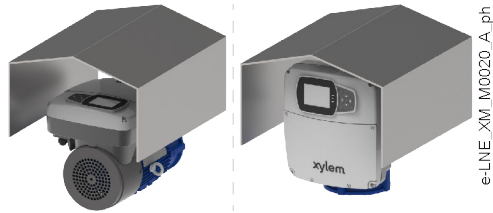

3. If the unit is fixed to a foundation, check that:
  - It is raised from the floor
  - Any leaks must not cause flooding to the installation area or submerge the unit.

### Air clearance between a wall and the external surfaces of the unit

- To ensure suitable ventilation:  $\geq 100$  mm (4 in)
- To permit inspection and removal of the motor:  $\geq 300$  mm (12 in)
- If the space available is any less, refer to the technical catalogue.

### Environments prone to condensation

If the ambient temperature is higher than the liquid temperature, or if the unit is installed outdoors, condensation may form inside the motor during idle periods. To prevent the formation of condensation, ensure that the drain hole in the motor flange is open and pointing downwards.

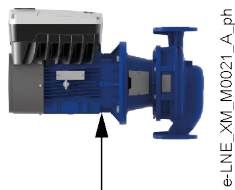

Condensate freezing can be prevented by keeping the unit powered at all times and activating the heating function with the motor at standstill (parameter P07.2.01, see the 001088110X manual).

### Thermal insulation

Do not cover the motor adapter with thermal insulators so as not to trap the vapours released by the mechanical seal, which can cause corrosion.

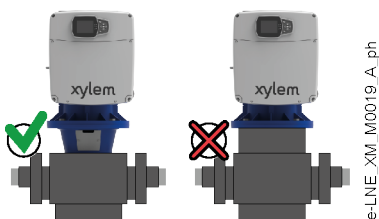

## 4.2.3 Requirements on the concrete foundation

- The concrete must have a compression resistance of C12/15 and meet the requirements of exposure class XC1 according to EN 206-1
- The surface should be as flat and level as possible.
- The dimensions must be suitable for the chosen supports, which are available as optional additional kits: see **Support kit**.

## 4.2.4 Support kit

### Brackets for e-LNE

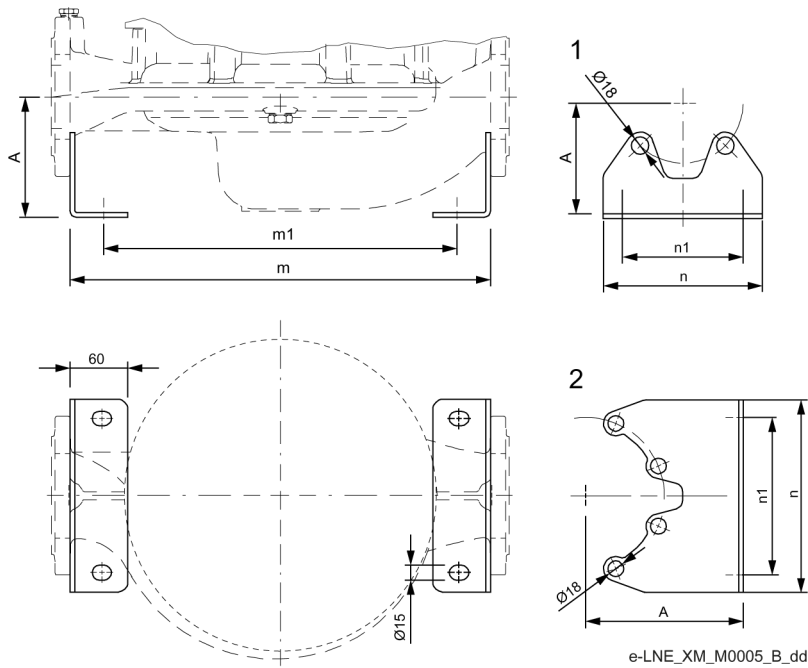

Unit size	Bracket shape	Bracket dimensions, mm				
		A	m	m1	n	n1
32-160	1	95	284	210	140	100
40-125/40-160		115	284	210	150	110
40-200/40-250		115	404	330	150	110
50-125/50-160		120	300	230	165	125
50-200/50-250		120	400	330	165	125
65-125/65-160		125	320	250	185	145
65-200/65-250		125	435	365	185	145
80-125/80-160		2	135	376	310	200
80-200/80-250	135		456	390	200	160
100-160	180		452	380	220	180
100-200/100-250	180		502	430	220	180

Support bases for e-LNE

40/50/65/80/100

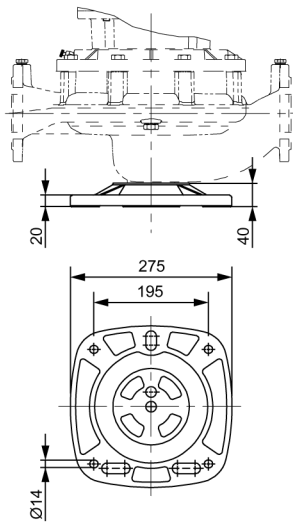

125/150

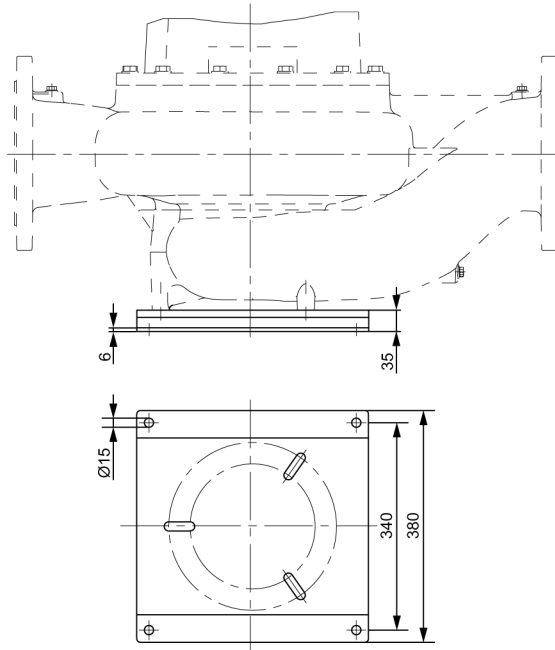

e-LNE\_XM\_M0004\_A\_dd

200/250

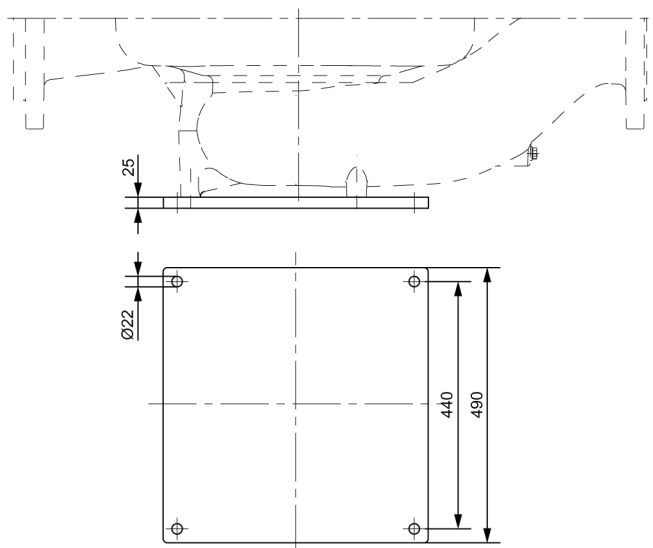

Support base kit for e-LNT

40 50 65 80 100

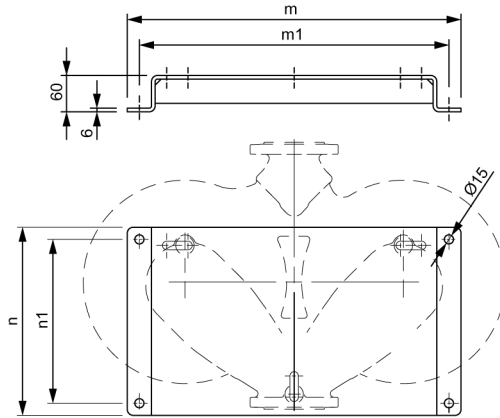

125/150

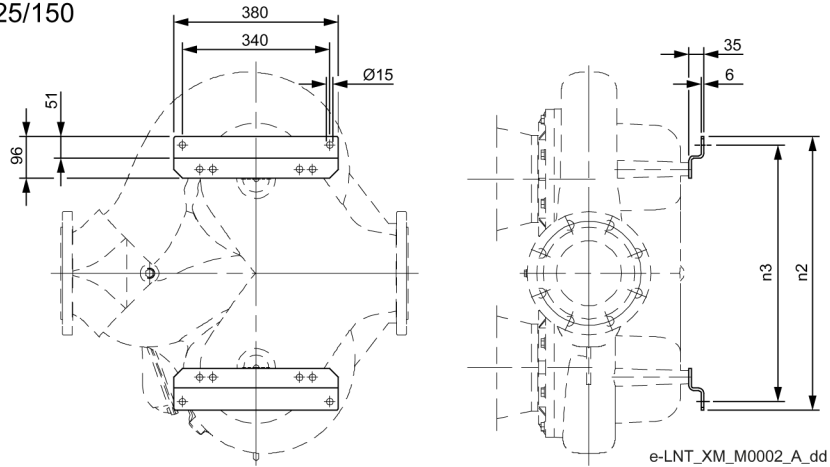

e-LNT\_XM\_M0002\_A\_dd

Unit size	Base dimensions, mm					
	M	m1	n	n1	n2	n3
40-125/40-160	500	460	280	240	-	-
40-200/40-250	550	510	340	300	-	-
50-125/50-160	500	460	280	240	-	-
50-200/50-250	550	510	340	300	-	-
65-125/65-160	500	460	280	240	-	-
65-200/65-250/80-160/80-200/80-250 80-315/100-160/100-200/100-250/100-315	550	510	340	300	-	-
125-160/125-200	-	-	-	-	572	532
125-250/125-315	-	-	-	-	652	612
150-200	-	-	-	-	672	632
150-250	-	-	-	-	632	592
150-315	-	-	-	-	672	632

## 4.2.5 Anchoring to the floor

1. Attach the support to the unit.
2. Place the unit on the foundation.
3. Using a spirit level, make sure that the unit is level.
4. Align the suction and discharge ports to their piping.
5. Secure the unit with bolts:
  - Appropriate
  - Suitable for the support material and the application conditions.

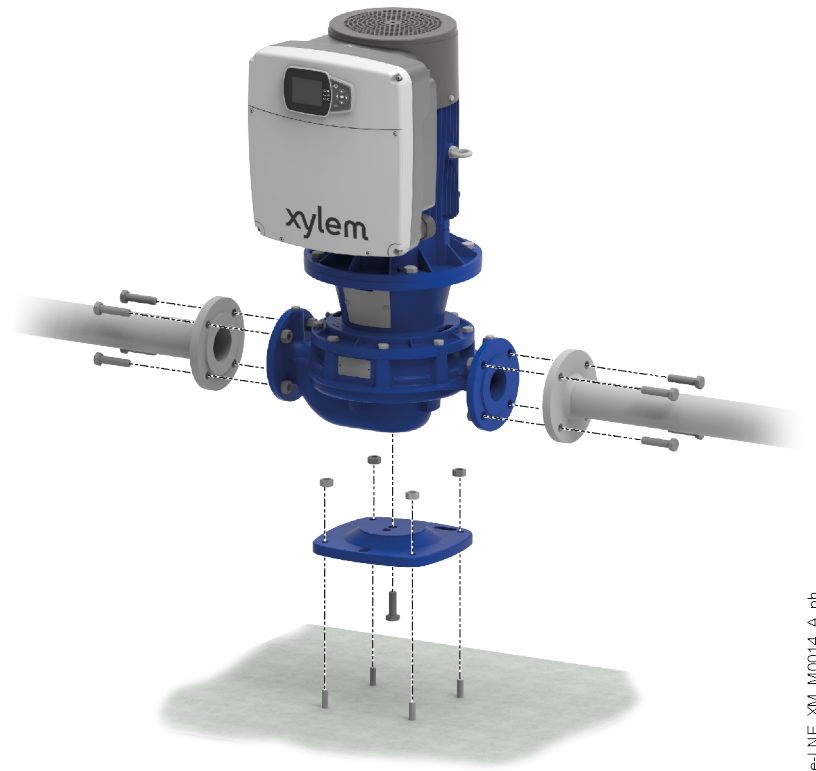

## 4.2.6 Reducing vibrations

The motor and the flow of liquids in the system can generate vibrations, amplified from the possible incorrect installation of the unit and the piping. See **Hydraulic connection**.

## 4.3 Hydraulic connection

1. Do not install the unit at the lowest point of the system, to avoid the accumulation of sediments.
2. Install an automatic relief valve at the highest point of the system to eliminate air bubbles.
3. Remove any welding residues, deposits and impurities in the pipes that could damage the unit; install a filter if necessary.
4. Support the piping system independently to prevent them from weighing on the unit.
5. To reduce the transmission of vibrations between the unit and the system and vice versa, install:
  - anti-vibration joints on the suction and discharge sides of the unit
  - dampers between the unit and the surface on which it is installed.
6. In order to reduce flow resistance, the pipe on the suction side must be:
  - For the section connected to the unit, straight and without bottlenecks, covering a length equal to at least six times the diameter of the suction port
  - Without bends; if this cannot be avoided, bends of a radius as wide as possible
  - Without traps and 'goosenecks'
  - With valves with a low specific flow resistance.

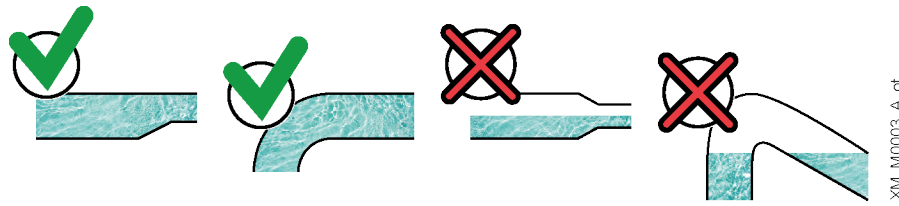

7. Install a check valve on the discharge side to prevent the liquid from flowing back into the pump unit when this is at standstill.
8. Install a pressure gauge on the suction side and one on the discharge side to check the duty point.
9. To exclude the unit from the system for the purpose of maintenance, install:
  - An on-off valve on the suction side
  - An on-off valve on the discharge side, downstream the check valve and pressure gauge, also useful for regulating the flow rate.
10. Install a control device in the suction that stops the unit in the event that the pressure falls below the pressure required for proper operation.

### 4.3.1 Loads applicable to the flanges

The tables show the maximum forces and torques that can be exerted by the piping on the flanges of the unit, both at the suction and the discharge.

Note: If not all the loads reach the maximum value, one of them may exceed it. See the technical catalogue for more information.

#### Unit fixed to the piping

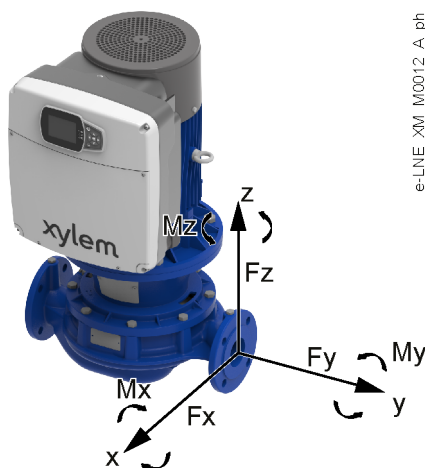

Unit size	Max Forces, N			Max Torques, Nm		
	Fx	Fy	Fz	Mx	My	Mz
32-160	450	530	430	550	380	430
40-125/40-160/40-200/40-250	550	630	500	650	450	530
50-125/50-160/50-200/50-250	750	830	680	700	500	580
65-125/65-160/65-200/65-250	930	1050	850	750	550	600
80-160/80-200/80-250/80-315	1130	1250	1030	800	580	650
100-160/100-200/100-250/100-315	1500	1680	1350	880	630	730
125-160/125-200/125-250/125-315	1780	1980	1600	1050	750	950
150-200/150-250/150-315	2250	2500	2030	1250	880	1030
200-250/200-315/200-400/250-315	3000	3350	2700	1630	1150	1330

Unit fixed to the floor

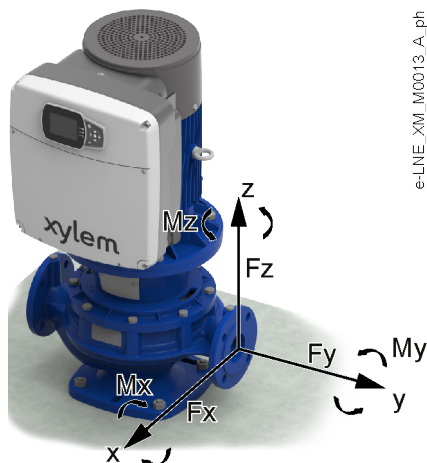

Unit size	Max Forces, N			Max Torques, Nm		
	Fx	Fy	Fz	Mx	My	Mz
32-160	340	400	320	300	130	180
40-125/40-160/40-200/40-250	420	470	380	400	200	280
50-125/50-160/50-200/50-250	570	620	510	450	250	330
65-125/65-160/65-200/65-250	700	790	640	500	300	350
80-160/80-200/80-250/80-315	850	940	770	550	330	400
100-160/100-200/100-250/100-315	1130	1260	1020	630	380	480
125-160/125-200/125-250/125-315	1330	1480	1200	800	500	700
150-200/150-250/150-315	1690	1880	1520	1000	630	780
200-250/200-315/200-400/250-315	2250	2520	2030	1380	900	1080

### 4.4 Guidelines for electrical connection

1. Check that the electrical leads are protected against:
  - High temperature
  - Vibrations
  - Collisions
  - Liquids.
2. Check that the power supply line is provided with:
  - A short circuit protection device of appropriate size
  - A mains disconnection device with contact opening distance ensuring complete disconnection for overvoltage III category conditions.

#### Isolated type networks (IT)

The installation of hydrovar X and hydrovar X+ units in distribution networks where the neutral is isolated from earth, must be evaluated according to the declared leakage current and the number of units to be connected. Contact Xylem or the Authorised Distributor for further information.



## 4.5 Guidelines for the control panel

### NOTE:

The control panel must match the ratings on the unit data plate.

1. Fit a system for protection against dry running to which to connect a pressure switch, or a float, probes or other suitable devices.
2. On the suction side install:
  - A pressure switch, in the case of connection to the mains water supply
  - A float switch or probes, in the case of liquid drawn from a tank or basin.

### 4.5.1 Fuses and/or automatic switches

- An electronically activated drive function ensures motor overload protection. The overload protection function calculates the increment level in order to activate the timing of the trigger function (motor stop).  
The higher the input current, the faster the response. The function provides Class 20 protection for the motor.
- The drive must be equipped with overcurrent and short-circuit protection to prevent the overheating of the power supply cables. Line fuses or automatic switches must be installed to ensure this protection. Fuses and automatic switches must be provided by the installer as part of the installation.
- Use the recommended fuses and/or automatic switches on the power supply side as protection in the event of drive component failure (first failure). The use of the recommended fuses and automatic switches ensures that possible damage to the drive is limited to the inside of the same. For other types of protection, ensure that the passing energy is equal to or less than that of the recommended models.
- Compliance with UL requirements is only ensured by using approved fuses of category JDDZ.2/8 type T and with the characteristics indicated below and in the table.
- The fuses shown in the table are suitable for use on a circuit capable of releasing 5000 Arms (symmetrical), maximum 480 V. With the indicated fuses, the short-circuit current rating (SCCR) for the drive is 5000 Arms.

The figure shows the recommended fuses and switches.

HVX, HVX+ model	Xylem motor model	Three-phase power supply voltage, Vac	Non-UL fuses, type gG, A	UL fuses, type T, manufacturer and model				MCB S203 model ABB Switches
				Bussmann	Edison	Littelfuse	Ferraz- Shawmut	
B	EXM.../3...B..	200 - 240	16	JJN-15	TJN (15)	JLLN 15	A3T15	C16
C	EXM.../3...C..		30	JJN-30	TJN (30)	JLLN 30	A3T30	C32
D	EXM.../3...D..		63	JJN-60	TJN (60)	JLLN 60	A3T60	C63
B	EXM.../4...B..	380 - 480	16	JJS-15	TJS (15)	JLLS 15	A6T15	C16
C	EXM.../4...C..		30	JJS-30	TJS (30)	JLLS 30	A6T30	C32
D	EXM.../4...D..		63	JJS-60	TJS (60)	JLLS 60	A6T60	C63

### NOTE:

Refer to the current shown on the data plate for the selection of the protective device and comply with local and national regulations for its sizing.

## 4.5.2 Ground fault circuit interrupter, GFCI

If a switch is installed to protect people against earth leakage, check that:

- It is suitably sized for the system configuration and environment of use
- It has a starting delay to prevent faults caused by transient earth currents
- It can detect alternate or direct current, it is marked with the symbols shown in the figure.

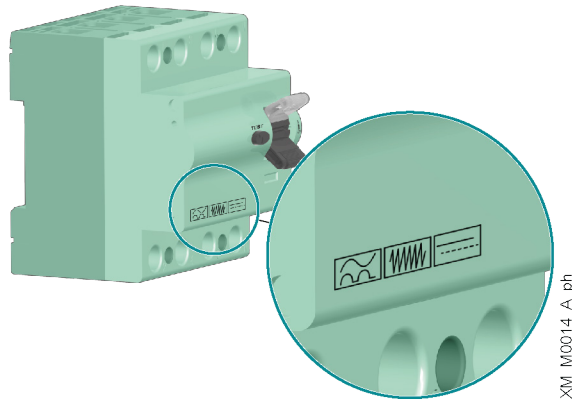

---

### NOTE:

When using an automatic earth leakage switch or an earth fault switch, make sure to consider the total earth leakage current of all the electric devices of the system.

---

## 4.6 Guidelines for the drive

### 4.6.1 Orientation of the drive display

It is possible to axially rotate the motor with the drive in order to orient the drive display in the most comfortable working position.

1. Remove the bolts that secure the motor to the pump body.
2. Rotate the motor 90°, 180° or 270°, without lifting it.

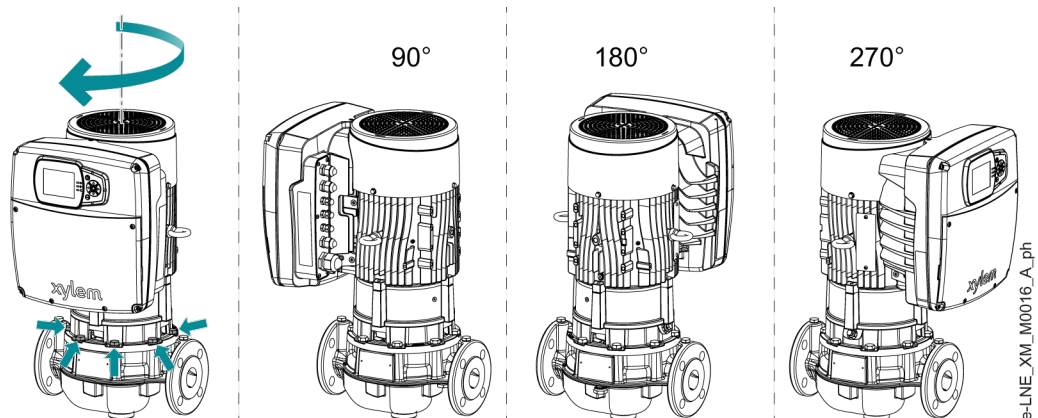

3. Reposition and tighten the bolts at the torque indicated in the table.

Bolt size	Torque, Nm (lbf-in)± 15%
M10	40 (354)
M12	70 (620)
M16	110 (974)

#### 4.6.2 Power supply connection

**NOTE:**

The cable cross section must be sized according to the rated current of the unit. Observe local and national regulations for cable sizing.

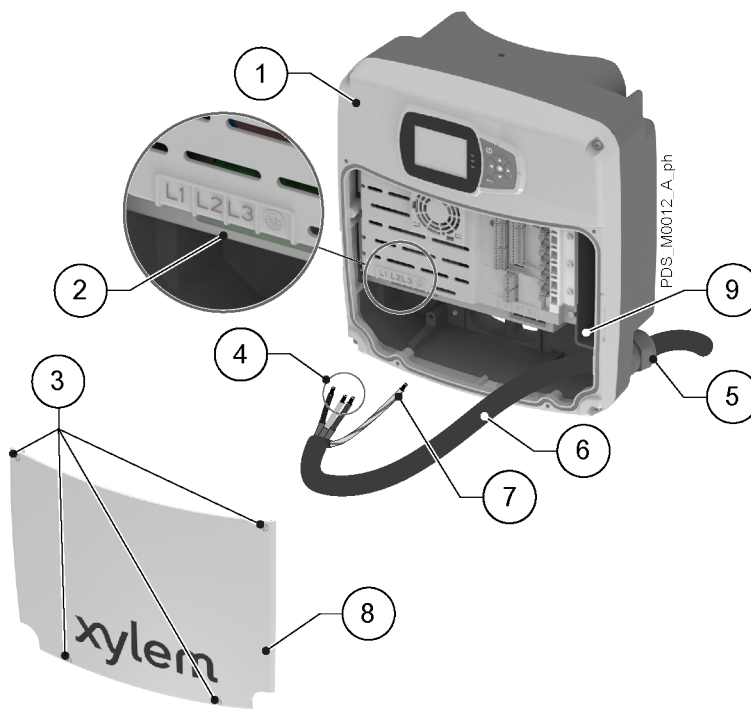

- 1. Drive
- 2. Terminals
- 3. Screws of the cover
- 4. Phase conductors
- 5. Cable Gland
- 6. Power supply cord
- 7. Protection conductor (earth)
- 8. Cover
- 9. Additional earth connection

1. Remove the cover and observe the wiring diagrams inside.
2. Insert the power cable in the power supply cable gland:

Drive size	Type of cable gland	Cable gland torque, Nm (lbf-in)
B	M20	6 (53)
C	M25	7 (71)
D	M40	12 (106)

3. Tightly connect the conductors, making sure that the protection one is longer than the phase ones. In models size:
  - B and C, open the springs with a slotted screwdriver with a maximum width of 2.5 mm (0.98 in)
  - D, tighten the terminal screws with a Pozidriv screwdriver and tightening torque of 4 Nm (35 lbf-in).

Note: For size D models, it is advisable to use cable terminals with a plastic sheath.
4. Tighten the cable gland.  
Torque: see the table in point 2.
5. Fit the cover and tighten the screws.  
Tightening torque: 3 Nm (27 lbf-in) ± 15%.

**Cable input characteristics**

Type of cable gland	Cable diameter, mm (in)	Tightening torque on the support plate, Nm (lbf-in)	Cable gland torque, Nm (lbf-in)	Number of inputs according to drive size		
				B	C	D
M12	3-6.5 (0.1-0.26)	2.7 (24)	1.5 (13)	3	3	5
M16	5-10 (0.2-0.4)	5 (44)	3 (27)	3	3	3
M25	11-17 (0.4-0.7)	7.5 (66)	7 (62)	1	1	-
M40	19-28 (0.7-1.1)	14 (124)	12 (106)	-	-	1

**NOTE:**

During installation, check that the cable glands on the support plate are tightened correctly, according to the values in the table.

**NOTE:**

When replacing cable glands and/or installing adapters, use suitable approved components to maintain degrees of protection IP55 and NEMA 4.

**Characteristics of power terminals and conductors**

Drive size	Connection type	Type and cross-section of installable conductors	Stripping length, mm (in)
B and C	Spring	<ul style="list-style-type: none"> <li>• Rigid: 1.5-10 mm<sup>2</sup></li> <li>• Flexible: 1.5-6 mm<sup>2</sup></li> <li>• Cable terminals without plastic sheath: 1.5-6 mm<sup>2</sup></li> <li>• Cable terminals with plastic sheath: 1.5-4 mm<sup>2</sup></li> <li>• UL/CSA compliant: AWG 16-8</li> </ul>	15 (0.6)
D	With screw	<ul style="list-style-type: none"> <li>• Rigid: 2.5-35 mm<sup>2</sup></li> <li>• Flexible: 2.5-25 mm<sup>2</sup></li> <li>• Cable terminals without plastic sheath: 2.5-25 mm<sup>2</sup></li> <li>• Cable terminals with plastic sheath: 2.5-25 mm<sup>2</sup></li> <li>• UL/CSA compliant: AWG 14-2</li> </ul>	

# 5 Use and Operation

## 5.1 Precautions



---

**WARNING: Injuries hazard**

Check that the protection devices of the coupling are installed, when applicable: risk of physical injury.

---



---



---

**WARNING:**

Make sure that the drained liquid cannot cause damage or injuries.

---



---



---

**WARNING:**

In the case of liquids that are excessively hot or cold, pay attention to the risk of injury.

---



---



---

**WARNING: Electrical hazard**

Check that the unit is properly connected to the mains power supply.

---



---



---

**WARNING: Hot surface hazard**

Be aware of the extreme heat generated by the unit.

---



---



---

**WARNING:**

It is prohibited to place flammable materials near the unit.

---



---



---

**NOTE:**

Check that the shaft can turn smoothly.

---



---



---

**NOTE:**

It is prohibited to operate the unit when dry, not primed and below the rated flow rate.

---



---



---

**NOTE:**

It is prohibited to operate the unit with the on-off valves closed or at zero flow rate: risk of damage due to overheating of the liquid.

---



---



---

**NOTE:**

It is prohibited to use the unit in the case of cavitation.

---



---



---

**NOTE:**

The unit must be filled and vented properly before it can be started.

---



---



---

**NOTE:**

The maximum pressure delivered by the unit at the discharge side, determined by the pressure available on the suction side, must not exceed the maximum pressure (PN).

---



---

## 5.2 Filling and priming

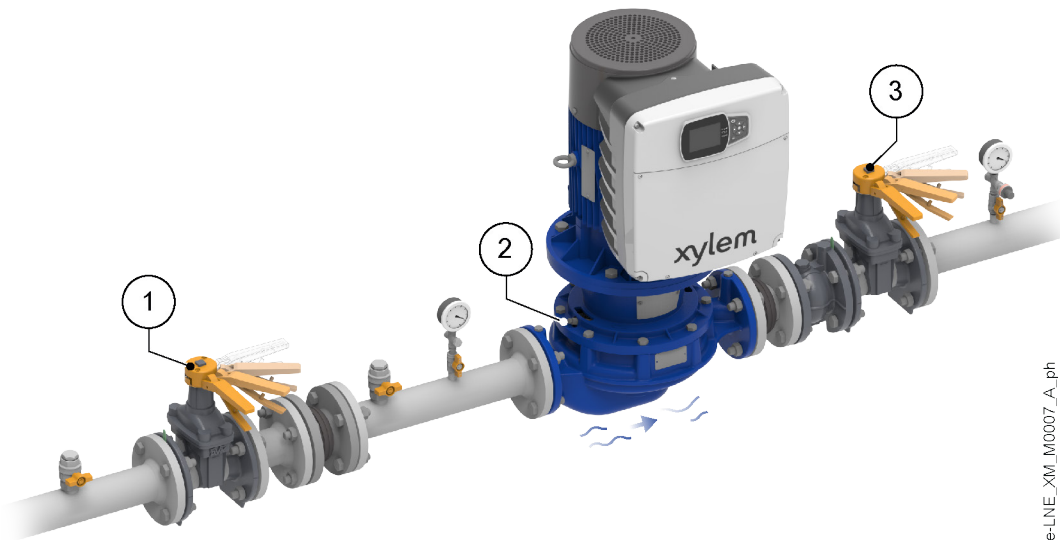

1. On-off valve on suction line
2. Bleed valve
3. On-off valve on discharge line

1. Close both on-off valves.
2. Loosen the relief valve.
3. Slowly open the suction valve until the liquid regularly comes out from the relief valve; if necessary, keep loosening it.
4. Tighten the relief valve.  
Tightening torque: 2 Nm (18 lbf·in).
5. Slowly and fully open the on-off valve.

## 5.3 Startup

---

### NOTE:

If there is a risk of the unit running at a flow rate below the minimum expected, install a bypass circuit.

---

### Preliminary checks

1. Check that the shaft can turn smoothly:
  - Insert a slotted screwdriver into the centre hole of the fan cover.
  - Insert the screwdriver in the appropriate recess on the shaft head
  - Turn the screwdriver: there must be no resistance to the movement.
2. Check that all the operations indicated **Filling and priming** on page 30 have been carried out correctly.

### Startup

1. Shut off the discharge on-off valve almost completely.
2. Fully open the suction on-off valve.
3. Start the unit.
4. Gradually open the discharge on-off valve until half open.
5. Wait a few minutes and then fully open the discharge on-off valve.

## Final operations



---

**WARNING:**

After startup, run the unit for a few minutes with several users open in order to wash the inside of the system.

---

With the unit in operation, check that:

- No liquid is leaking from the unit or pipes
  - The pressure on the display is the same as that measured by the discharge pressure gauge
  - There is no unwanted noise or vibrations
  - Any devices that detect the absence of liquid or minimum pressure are working correctly
  - The maximum pressure of the unit at the discharge, determined by the available suction pressure, must not exceed the maximum pressure (PN).
- 

**NOTE:**

If the unit does not deliver the required pressure, repeat the operations in **Filling and priming** on page 30.

---

## Settling of the mechanical seal

The pumped liquid lubricates the seal faces of the mechanical seal; under normal conditions, a small amount of liquid may leak out. When the unit is run for the first time, or immediately after the seal is replaced, more liquid may temporarily leak out. To help the seal settle and to reduce leaking:

1. Close and open the on-off valve on the discharge side two or three times with the unit running.
2. Stop and start the unit two or three times.

## 5.4 Manual stop

Stop the unit:

- By pressing ON/OFF on the drive display, or
- By opening the external START/STOP enable contact, where applicable.

# 6 Control

## Introduction



**DANGER: Electrical hazard**

If the drive display is damaged, contact Xylem or the Authorised Distributor.



**WARNING: Hot surface hazard**

Only touch the drive display buttons. Pay attention to the high temperature released by the unit.

Depending on model, please observe the instructions in the following paragraphs:

- e-LNE and e-LNT hydrovar X+, LN..X drive display on page 32.
- e-LNE and e-LNT hydrovar X, LN..K drive display on page 35.

Programming instructions can be found in Manual no. 001088110X.

## 6.1 LN..X drive display

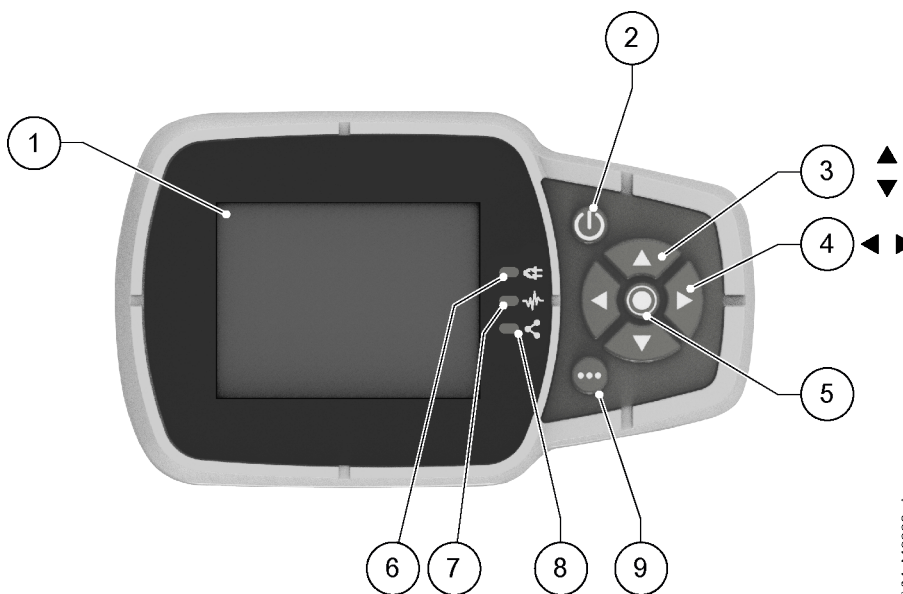

XM\_M0002\_A\_sc

Position number	Name	Function
1	Display	
2	ON/OFF button	<ul style="list-style-type: none"> <li>• Start and stop the unit</li> <li>• Reset the errors by pressing for 5 seconds.</li> </ul>
3	UP and DOWN arrow keys	<ul style="list-style-type: none"> <li>• Move vertically between menu options</li> <li>• Perform a manual switch-over on a multi-pump system by pressing the DOWN arrow (extended pressure)</li> <li>• Rotate the display 180° by simultaneously pressing ENTER and the UP arrow (extended pressure).</li> </ul>
4	RIGHT and LEFT arrow keys	<ul style="list-style-type: none"> <li>• Move horizontally to navigate home screens and menus</li> <li>• Lock and unlock the display by simultaneously pressing the RIGHT and LEFT arrows (extended pressure).</li> </ul>



Position number	Name	Function
5	SEND button	<ul style="list-style-type: none"> <li>Advancing through the menu levels</li> <li>Confirm the selection of a parameter</li> <li>Confirm the value of a parameter.</li> </ul>
6	Unit LED on	Indicate that the unit is powered.
7	Unit status LED	Indicate: <ul style="list-style-type: none"> <li>Motor not powered (off)</li> <li>Alarm active and motor stopped (yellow)</li> <li>Unit error and motor stopped (red)</li> <li>Motor started (green)</li> <li>Alarm active and motor started (yellow alternating green).</li> </ul>
8	Connection status LED	Indicate: <ul style="list-style-type: none"> <li>BMS communication disabled (off)</li> <li>BMS communication active (green)</li> <li>Wireless communication with mobile device established (fixed blue)</li> <li>Wireless communication with mobile device being established (flashing blue)</li> <li>Wireless communication and BMS communication active (blue alternating green).</li> </ul>
9	Multifunction button	<ul style="list-style-type: none"> <li>Access the parameter menu or additional functions according to the screen on the display.</li> <li>Enable wireless connection (extended pressure).</li> </ul>

### 6.1.1 Graphic display

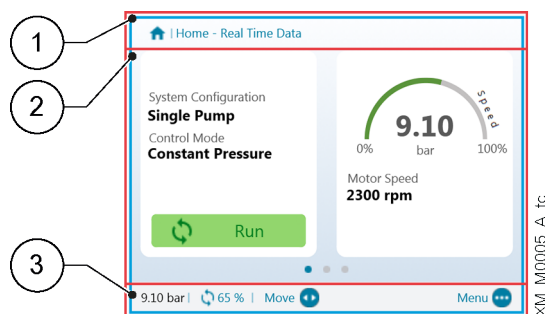

Position number	Name	Description
1	Header bar	It shows static information and messages relating to the operating conditions, such as: <ul style="list-style-type: none"> <li>Alarms</li> <li>Errors</li> <li>Multi-pump operation.</li> </ul>
2	Main screen	It shows the main information and allows the operating parameters to be changed. There are up to 5 screens, which can be navigated by pressing the RIGHT and LEFT arrow keys. The symbol  next to an entry indicates an editable parameter.
3	Lower bar	Show: <ul style="list-style-type: none"> <li>On the left, the essential operating information, such as the actual adjustment value and the speed percentage at which the unit is operating</li> <li>On the right, the buttons available for interaction in the main screen.</li> </ul>

### 6.1.2 Parameter menu, LN..X

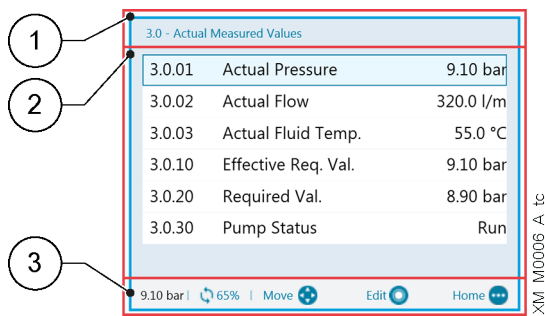

Position number	Name	Description
1	Header bar	It shows the parameter path at menu and submenu level.
2	Parameter list	Show: <ul style="list-style-type: none"> <li>• The index,</li> <li>• The name,</li> <li>• The preview of the value</li> </ul> of the parameters for the current menu level. To advance a level or change the value, press SEND or the RIGHT arrow key.
3	Lower bar	Show: <ul style="list-style-type: none"> <li>• On the left, the essential operating information, such as the actual adjustment value and the speed percentage at which the unit is operating</li> <li>• On the right, the buttons available for interaction in the main screen.</li> </ul>

The menu is split into 3 levels:

- Main
- Submenu
- Parameters.

To display or change a parameter:

1. Press the function button in the main screen.
2. Enter the password using the arrow keys.
3. Press SEND.

Note: after 10 minutes of inactivity, the password must be re-entered.

4. Press the RIGHT arrow key or SEND to advance between levels, or the LEFT arrow key to return.

### 6.1.3 LN..X unit start

1. Check the connection between the START/STOP and GND inputs on the terminal board.
2. Press ON/OFF to start the unit.  
 Note: if parameter 1.0.45 Autostart is configured to "Yes", it will not be necessary to press ON/OFF again at the next start.
3. With the unit in operation, the working setpoint can be changed by switching to the second screen.

### 6.1.4 Operating mode change, LN..X

The unit parameters are set at the factory and the unit is ready for use.

To change parameters and advanced features, access the configuration menu.

1. Press the multi-function button.
2. Enter the password using the arrow keys.
3. Press SEND.
4. Navigate through the menus to locate the parameter or function to be changed: see Manual no. 001088110X for the association between parameter codes and their functions.

### 6.1.5 Error reset, LN..X

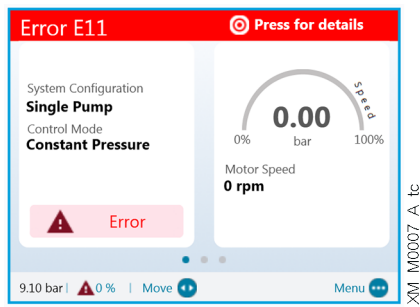

In the event of an error, the unit automatically makes several attempts to reset itself, where permitted: if the attempts are unsuccessful, the unit stops and the display shows the error code.

To eliminate the error:

1. Open the first main screen by pressing SEND.
2. Read the description of the error in the screen.
3. Identify the cause and follow the instructions **Troubleshooting** on page 43.
4. Reset the error by pressing and holding down ON/OFF for 3 seconds: the unit returns to the status before the error.



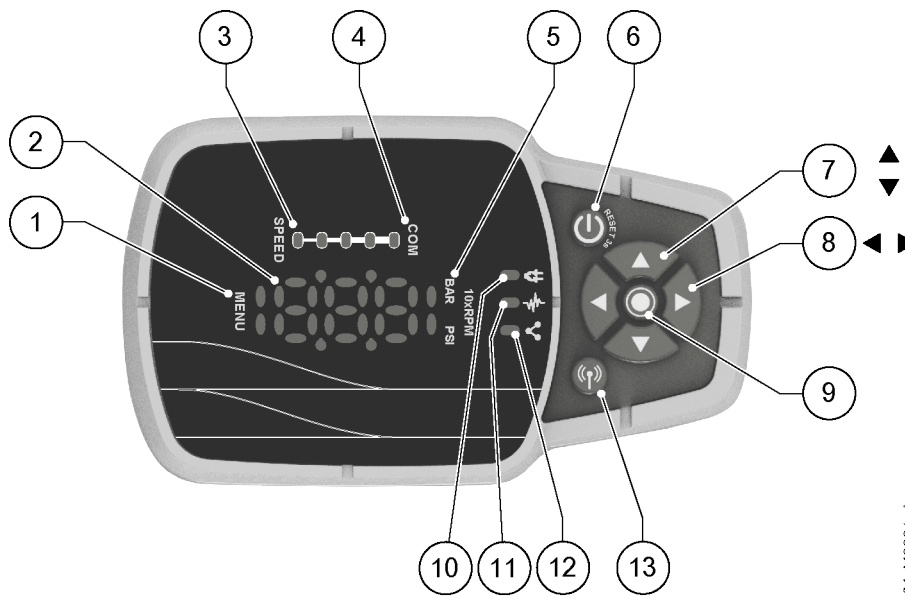



### 6.2 LN..K drive display



Position number	Name	Function
1	Menu indicator	Indicate: <ul style="list-style-type: none"> <li>• Navigation through the menu items (steady light)</li> <li>• The display of a parameter value (flashing light).</li> </ul>
2	Seven-segment display	
3	Speed bar	
4	Multi-pump communication indicator	

Position number	Name	Function
5	Unit of measure indicator	
6	ON/OFF button	<ul style="list-style-type: none"> <li>Start and stop the unit</li> <li>Reset the errors by pressing for 5 seconds.</li> </ul>
7	UP and DOWN arrow keys	<ul style="list-style-type: none"> <li>Quickly change the setpoint in the main display</li> <li>Navigate through the submenus and change the parameter displayed in the parameter menu</li> <li>Perform a manual switch-over on a multi-pump system by pressing the DOWN arrow (extended pressure)</li> <li>Rotate the display 180° by simultaneously pressing ENTER and the UP arrow (extended pressure).</li> </ul>
8	RIGHT and LEFT arrow keys	<ul style="list-style-type: none"> <li>Show speed and pressure in alternation in the main display</li> <li>Navigate the parameter menu levels</li> <li>LEFT arrow only, confirm the changed value</li> <li>Lock and unlock the display by simultaneously pressing the RIGHT and LEFT arrows (extended pressure).</li> <li>RIGHT arrow only, navigate through the active error codes, if more than one are present.</li> </ul>
9	SEND button	<ul style="list-style-type: none"> <li>Advancing through the menu levels</li> <li>Confirm the value of a parameter</li> <li>Enter the parameter configuration menu (extended pressure).</li> </ul>
10	Unit LED on	Indicate that the unit is powered.
11	Unit status LED	Indicate: <ul style="list-style-type: none"> <li>Motor not powered (off)</li> <li>Alarm active and motor stopped (yellow)</li> <li>Unit error and motor stopped (red)</li> <li>Motor started (green)</li> <li>Alarm active and motor started (yellow alternating green).</li> </ul>
12	Connection status LED	Indicate: <ul style="list-style-type: none"> <li>BMS communication disabled (off)</li> <li>BMS communication active (green)</li> <li>Wireless communication with mobile device established (fixed blue)</li> <li>Wireless communication with mobile device being established (flashing blue)</li> <li>Wireless communication and BMS communication active (blue alternating green).</li> </ul>
13	Wireless technology communication button	Connect the unit to a mobile device.

## 6.2.1 Main visualization

Glyph	Name	Description
	OFF	Unit stopped with ON/OFF button or BMS. Note: lower priority in relation to STOP.
	STOP	START/STOP and GND digital inputs open.
	Start request	Request to start the unit with the ON/OFF button. It remains active for a few seconds, then the following appears: <ul style="list-style-type: none"> <li>• Unit in operation, or</li> <li>• Alarm, or</li> <li>• Error.</li> </ul>
	Alarm	Alarm code of the unit in alarm status, in alternation with the main display. The unit status LED can be: <ul style="list-style-type: none"> <li>• Yellow= motor stopped</li> <li>• Yellow in alternation with green = motor started.</li> </ul>
	Error	Error code of the unit in error status.
	Unit in operation	Unit in operation and selected unit of measure display: <ul style="list-style-type: none"> <li>• Speed, 10xRPM</li> <li>• Pressure in bar or psi.</li> </ul>
	Display blocked	Display locked by the operator and button operation inhibited.

## 6.2.2 Parameter menu, LN..K





The menu is split into 3 levels:

- Main
- Submenu
- Parameters.

To display or change a parameter:

1. Press the SEND button (extended pressure).
2. Enter the password using the arrow keys.
3. Press SEND.  
Note: after 10 minutes of inactivity, the password must be re-entered.
4. Press the UP and DOWN arrow keys to navigate through the menus.
5. Press SEND or the RIGHT arrow to go to the menu sub-levels until the parameter value is found.
6. Press the UP and DOWN arrow keys to increase or decrease the parameter value.
7. Press SEND or the LEFT arrow key to confirm.

Note: after 5 seconds of inactivity, the parameter returns to the previously set value.

Glyph	Name	Notes
	Main menu	<ul style="list-style-type: none"> <li>• Menus numbered from 1 to 9.</li> <li>• Menu indicator: fixed light.</li> </ul>
	Submenu	<ul style="list-style-type: none"> <li>• Submenus numbered from 1 to 9.</li> <li>• Menu indicator: fixed light.</li> </ul>
	Parameter	Navigation in the parameter level. <ul style="list-style-type: none"> <li>• Parameters numbered from 0 to 99.</li> <li>• Submenus numbered from 1 to 9.</li> <li>• Menu indicator: fixed light.</li> </ul>
	Parameter value	Parameter value modification. <ul style="list-style-type: none"> <li>• Menu indicator: light flashing.</li> <li>• Parameter value while editing: flashing.</li> </ul>

### 6.2.3 LN..K unit start

1. Check the connection between the START/STOP and GND inputs on the terminal board.
2. Press ON/OFF to start the unit.  
Note: if parameter 1.0.45 Autostart is configured to "Yes", it will not be necessary to press ON/OFF again at the next start.
3. With the unit in operation, the control setpoint can be changed with immediate effect using the UP and DOWN arrow keys.

### 6.2.4 Operating mode change, LN..K

The unit parameters are set at the factory and the unit is ready for use.

To change parameters and advanced features, access the configuration parameters.

1. Press the SEND button (extended pressure).
2. Enter the password using the arrow keys.
3. Press SEND.
4. Select the parameter to be changed in menu M01: see the 001088110X manual for the association between parameter codes and their functions.

### 6.2.5 Error reset, LN..K

In the event of an error, the unit automatically makes several attempts to reset itself, where permitted: if the attempts are unsuccessful, the unit stops and the display shows the error code. To eliminate the error:

1. Identify the cause and follow the instructions in **Troubleshooting**.
2. Reset the error by pressing and holding down ON/OFF for 3 seconds: the unit returns to the status before the error.

## 6.3 Xylem X App

### Introduction

Available for mobile devices with wireless technology operating system.

Use the App to:

- Check the status of the unit
- Configure parameters
- Interact with the unit and obtain data during installation and maintenance
- Generate a work report
- Contact the assistance service.

### Download the App and connect the mobile device with the unit

1. Download the Xylem X App to the mobile device from App Store<sup>1</sup> or Google Play<sup>2</sup> by scanning the QR code:



---

<sup>1</sup> Compatible with iOS® operating systems with version 11.0 and above

<sup>2</sup> Compatible with Android operating systems with version 8.0 and above

## 2. Complete the registration.

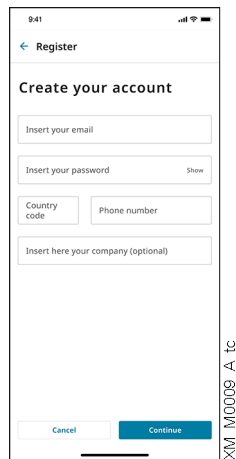

3. On the drive display, press the wireless communication button.
4. Add the unit to the user profile.

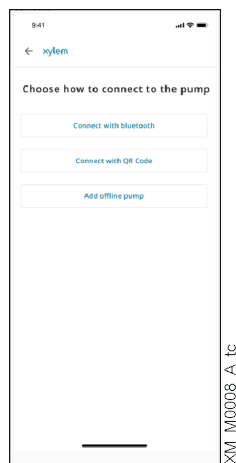

5. When the connection has been established, the connection light turns blue steady: it is now possible to control the unit using the mobile device.

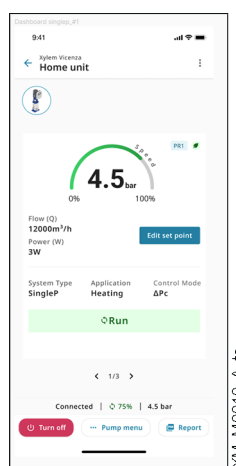

# 7 Maintenance

## 7.1 Precautions

Before starting, make sure that the safety instructions shown in **Introduction and Safety** on page 5 have been fully read and understood.



---

**DANGER: Electrical hazard**

Before starting work, check that the electric power supply is disconnected and locked out, to avoid unintentional restart of the unit, the control panel and the auxiliary control circuit.

---

---



---

**DANGER: Electrical hazard**

After disconnecting the system from the power supply, wait 2 min for the discharge of the residual current.

---

---



---

**WARNING:**

Maintenance must be done by a technician possessing the technical-professional requirements outlined in the current regulations.

---

---



---

**WARNING:**

Always wear personal protective equipment.

---

---



---

**WARNING:**

Always use suitable working tools.

---

---



---

**WARNING:**

In the case of liquids that are excessively hot or cold, pay attention to the risk of injury.

---

---

The disassembly or installation of the rotor in the motor casing generates a strong magnetic field:

---

---



---

**DANGER: Magnetic hazard**

The magnetic field may be dangerous for anyone wearing pacemakers, or any other medical devices sensitive to magnetic fields.

---

---

---

**NOTE:**

The magnetic field may attract metal debris on the rotor surface, causing damage to the same.

---

---



## 7.2 Maintenance every 4000 hours of operation, or every year

Perform maintenance when one of the two limits is reached.

### Maintenance with unit stopped

1. Check:
  - The tightening of all bolts
  - The integrity of the power cable
  - For size D only, the tightening of the conductor terminals with a torque of 4 Nm (35 lbf·in)
  - That there are no signs of overheating and electric arcs on the terminal boxes and traces of humidity in the drive.
2. Clean:
  - The fan cover
  - The drive dissipator
  - The stator casing
 and check the status of the cooling fan.

### Maintenance with unit started

Check:

1. That the unit does not produce abnormal noises or vibrations.
2. That no liquid is leaking from the unit and the piping system.
3. e-LNT models: test the operation of the flap valve by running the units one at a time and checking that the one that is not powered is not moving.

## 7.3 Maintenance every 10000 hours of operation or every 2 years

When the first of the two limits is reached, replace the mechanical seal and the O-Rings of the pump body.

## 7.4 Maintenance every 17500 hours of operation or every 5 years

When the first of the two limits has been reached, replace the permanently lubricated bearings of the motor, if present.

## 7.5 Blind flanges for e-LNT models

If maintenance needs to be carried out on one pump only, it will be possible to continue to operate the other one by installing a closing flange.



## 7.6 Long periods of inactivity

1. Shut the suction and discharge on-off valves.
2. Comply with the instructions on **Storage** page 11.
3. Before starting the unit, check the status of the connections of the electric conductors on the unit and the control panel.
4. Start the unit complying with the instructions on **Startup** page 30.

## 7.7 Tightening torques of the threaded connections

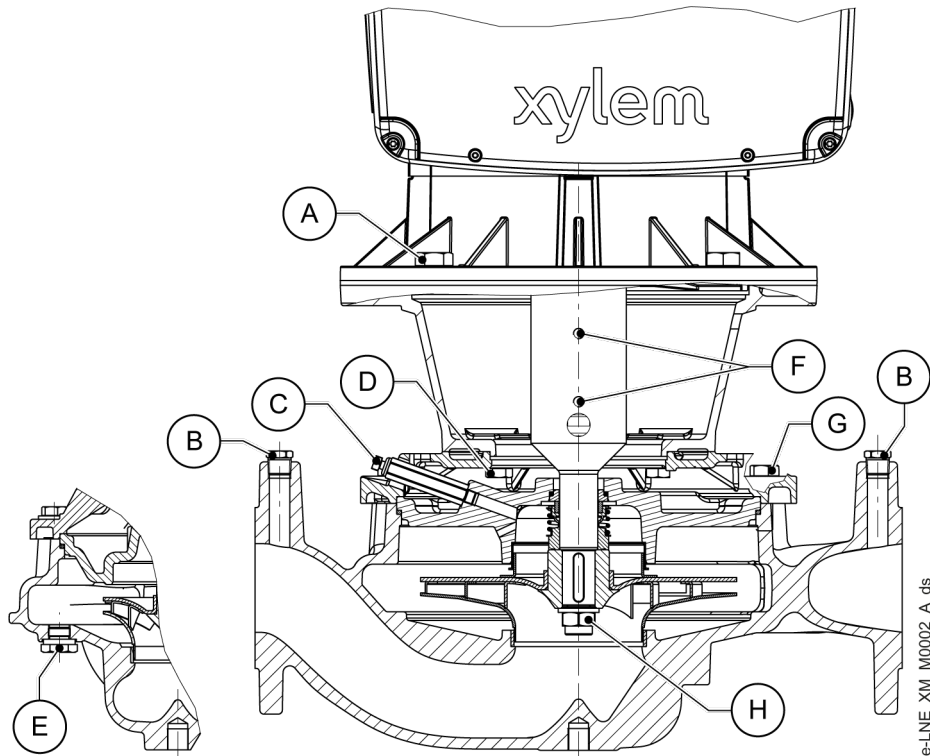

Position number	Connector	Torque, Nm (lbf-in)	Position number	Connector	Torque, Nm (lbf-in)
A	M8	15 (133)	F	M6	6 (53)
	M10	32 (283)		M8	13 (115)
	M12	45 (398)		2 x M10	28 (248)
	M16	110 (974)		3 x M10	13 (115)
6 x M10				13 (115)	
B	1/4"	15 (133)	G	M10	40 (354)
	3/8"	40 (354)		M12	70 (620)
	1/2"	60 (531)		M16	110 (974)
C	1/8"	20 (177)	H	7/16" -20	25 (221)
D	M8	15 (133)		M12x1.25	45 (398)
	M10	32 (283)		M16x1.25	110 (974)
E	1/4"	15 (133)		M24x1.25	200 (1770)
	3/8"	40 (354)		M30x2	180 (1593)
	1/2"	60 (531)			

## 7.8 Identification of spare parts

Identify the spare parts with the product codes directly on the site [spark.xylem.com](http://spark.xylem.com). Contact Xylem or the Authorised Distributor for further technical information.

# 8 Troubleshooting

**WARNING:**

Maintenance must be done by a technician possessing the technical-professional requirements outlined in the current regulations.

**WARNING:**

If a fault cannot be corrected or is not mentioned, contact Xylem or the Authorised Distributor.

## 8.1 The unit does not switch on

Cause	Solution
Electric power supply absent	Restore the electric power supply
Power supply cord is damaged	Replace the cable
Unit faulty	Contact Xylem or the Authorised Distributor, or send the unit to an authorised workshop

## 8.2 Little or no hydraulic performance

Cause	Solution
Air inside the unit	<ul style="list-style-type: none"> <li>• Bleed the unit and/or</li> <li>• Remove any turbulences of the liquid in the suction area, and/or</li> <li>• Check the suction conditions</li> </ul>
Check valve at the discharge blocked or partially blocked	Replace the check valve
Discharge piping system choked and/or obstructed	Remove all choking and/or obstructions
Suction filter clogged, if present	Clean the filter
Foreign bodies in the unit	Remove the foreign bodies
Flap valve damaged, worn or faulty (e-LNT models)	Replace the flap valve
Wrong unit settings	Check the settings
Undersized unit	Contact Xylem or the Authorised Distributor, or send the unit to an authorised workshop
Damaged or worn internal unit components	Contact Xylem or the Authorised Distributor, or send the unit to an authorised workshop
Unit faulty	Contact Xylem or the Authorised Distributor, or send the unit to an authorised workshop

### 8.3 Non-powered unit runs in reverse (e-LNT models)

The unit switched off turns in the opposite direction when the other one is in operation.

Cause	Solution
Flap valve faulty	Contact Xylem or the Authorised Distributor, or send the unit to an authorised workshop

### 8.4 The differential protection device (RCD) has tripped

Cause	Solution
Differential unsuitable or faulty	Check or repair the differential
Unit faulty	Contact Xylem or the Authorised Distributor, or send the unit to an authorised workshop

### 8.5 The unit produces excessive noise and/or vibrations

Cause	Solution
Plant resonance	Check the installation
Foreign bodies in the unit	Contact Xylem or the Authorised Distributor, or send the unit to an authorised workshop
Cavitation	Check the suction conditions
Air inside the unit	<ul style="list-style-type: none"> <li>• Bleed the unit and/or</li> <li>• Remove any turbulences of the liquid in the suction area, and/or</li> <li>• Check the suction conditions</li> </ul>
Unit wrongly anchored to the foundations	Check the unit anchoring
Anti-vibration joint on the piping system not suitable or absent	Install or check the anti-vibration
Unit faulty	Contact Xylem or the Authorised Distributor, or send the unit to an authorised workshop

### 8.6 The unit is leaking at the mechanical seal

Cause	Solution
Mechanical seal damaged or worn	Replace the seal or contact Xylem or the Authorised Distributor, or send the unit to an authorised workshop

### 8.7 Unit error or alarm

Cause	Solution
Miscellaneous	See manual the 001088110X manual

# 9 Specifications

## 9.1 Operating environment

Non-aggressive and non-explosive atmosphere.

### Temperature

From 0 to 40°C (32÷104°F), unless otherwise indicated on the data plate of the electric motor.

### Relative air humidity

< 50% at 40°C (104°F).

### NOTE:

If the humidity exceeds the stated limits, contact Xylem or the Authorised Distributor.

### Elevation

< 1000 m (3280 ft) above sea level.

### NOTE: Danger of motor overheating

If the unit is exposed to temperatures or installed at an altitude greater than those stated, reduce the power output of the motor according to the coefficients reported in the table. Otherwise, replace the motor with a more powerful one.

If the unit is installed at an altitude exceeding 2000 m (6600 ft), contact Xylem or the Authorised Distributor.

Altitude m (ft)	Power reduction coefficient
1000÷1500 (3300÷4900)	0.97
1500÷2000 (4900÷6600)	0.95

## 9.2 Maximum operating pressure

The chart shows the pumped liquid pressure and temperature limits permitted for the mechanical seal, based on the material of the hydraulic components.

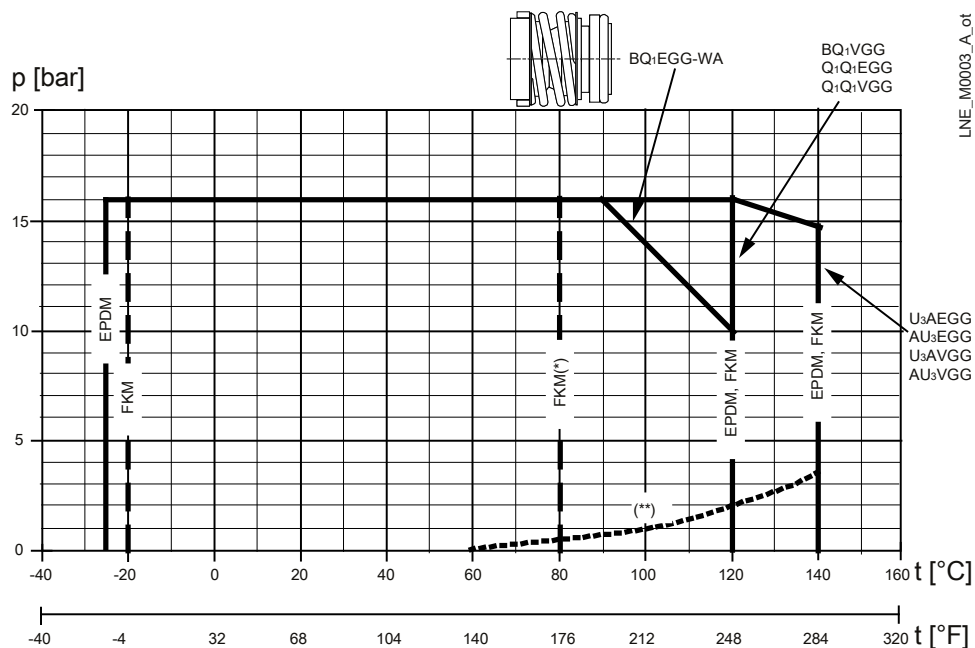

- (\*) = hot water
- (\*\*) = minimum pressure required at mechanical seal

### 9.3 Maximum number of starts and stops

≤ 4/h.

**NOTE:**

If more starts and stops are required, use the dedicated external input.

### 9.4 Electrical specifications

See the motor data plate.

Permitted tolerances for the supply voltage

- 200 - 240 V ±10% 50/60 Hz
- 380 - 480 V ±10% 50/60 Hz.

Leakage Current

≤ 3.5 mA (AC).

Protection class

IP 55.

### 9.5 Radio frequency characteristics

Features	Description
Technology	Wireless Low Energy 5.2
Band	2.4 GHz ISM
RF	≤ 4.5 mW (6.5 dBm)

### 9.6 Characteristics of inputs and outputs

Features	Description
Communication ports	2, RS-485
Digital inputs	3 for LN..K, 5 for LN..X: <ul style="list-style-type: none"> <li>• Floating/NPN contact, open manifold/drain open, to GND</li> <li>• Internal polarisation +24 VDC, current limited to 6 mA max.</li> <li>• Protection from -0.5 VDC to +30 VDC, ±15 mA max.</li> </ul>
Analogue inputs	2 for LN..K, 4 for LN..X: <ul style="list-style-type: none"> <li>• Configurable or 0-20 mA current, or 0-10 V voltage</li> <li>• 24V signal for sensor power supply with current limitation 60 mA</li> </ul>
Analogue output	Configurable as either 0-20 mA current signal or 0-10 V voltage signal
Relay	2, with NC and NO changeover contact: <ul style="list-style-type: none"> <li>• Relay 1 up to 240 VAC 0.25 A or 30 VDC 2 A</li> <li>• Relay 2 up to 30 VAC 0.25 A or 30 VDC 2 A</li> </ul>



**WARNING:**

If relay 1 is connected to a voltage higher than 30 VAC, disconnect and do not use the terminals of relay 2.

## 9.7 Sound pressure

Measured in free field at a distance of one metre from the unit, operating without load.

Unit size	LpA, dB ± 2	Unit size	LpA, dB ± 2
32-480	<70	80-320	70
40-420	<70	80-410	70
40-470	<70	80-500	78
40-600	71	80-520	71.5
40-720	<70	80-570	71.5
40-810	71	80-630	71.5
50-320	<70	100-110	<70
50-390	<70	100-150	<70
50-490	<70	100-280	71.5
50-590	71	100-370	72
50-720	70	100-400	72
50-800	70	100-430	72
50-900	75	125-100	<70
65-190	<70	125-140	<70
65-300	<70	125-180	<70
65-340	<70	125-270	<70
65-360	<70	125-340	<70
65-490	70	150-130	<70
65-610	70	150-210	<70
65-770	71.5	150-170	<70
80-210	<70	150-270	<70

## 9.8 Materials in contact with the liquid

Pump body material	Impeller material	Identification code	Status
Cast iron	Stainless steel	CS	Standard
	Cast iron	CC	
	Bronze	CB	Optional
	Stainless steel 1.4408	CN	
	Duplex	CR	

## 9.9 Mechanical seal

Unbalanced single acc. EN 12756, version K.

# 10 Disposal

## 10.1 Precautions



**WARNING:**

The unit must be disposed of through approved companies specialised in the identification of different types of materials (steel, copper, plastic, etc.).



**WARNING:**

It is prohibited to dispose of lubricating fluids and other hazardous substances in the environment.

## 10.2 WEEE (EU/EEA)

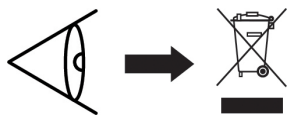

INFORMATION TO USERS pursuant to art. 14 of the Directive 2012/19/EU of the European Parliament and of the Council of 4 July 2012 on waste electrical and electronic equipment (WEEE). The crossed bin symbol on the appliance or on its packaging indicates that the product at the end of its useful life must be collected separately and not disposed of together with other mixed urban waste. Appropriate separate collection for the subsequent start-up of the disused equipment for recycling, treatment and environmentally compatible disposal helps to avoid possible negative effects on the environment and on health and favours the re-use and / or recycling of the materials of which the equipment is composed.

WEEE from users other than private households<sup>3</sup>: the separate collection of this equipment at the end of its life is organized and managed by the producer<sup>4</sup>. The user who wants to get rid of this equipment can then contact the producer and follow the system that it has adopted to allow the separate collection of equipment at the end of life or select an organization independently authorized to manage waste.

## 10.3 WEEE (UK)

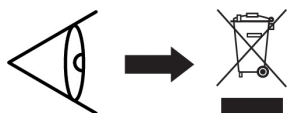

INFORMATION TO USERS pursuant to art. 44 of the The Waste Electrical and Electronic Equipment Regulations 2013 (S. I. 2013 No. 3113). The crossed bin symbol on the appliance or on its packaging indicates that the product at the end of its useful life must be collected separately and not disposed of together with other mixed urban waste. Appropriate separate collection for the subsequent start-up of the disused equipment for recycling, treatment and environmentally compatible disposal helps to avoid possible negative effects on the environment and on health and favours the re-use and / or recycling of the materials of which the equipment is composed.

WEEE from users other than private households<sup>5</sup>: the separate collection of this equipment at the end of its life is organized and managed by the producer<sup>6</sup>. The user who wants to get rid of this equipment can then contact the producer and follow the system that it has adopted to allow the separate collection of equipment at the end of life or select an organization independently authorized to manage waste.

<sup>3</sup> Classification according to product type, use and current local laws

<sup>4</sup> Producer of EEE as per Directive 2012/19/EU

<sup>5</sup> Classification according to product type, use and current local laws

<sup>6</sup> Producer of EEE as per WEEE Regulations 2013



# 11 Declarations

Refer to the specific declaration relating to the marking on the product.



## 11.1 EC Declaration of Conformity (Original)

Xylem Service Italia S.r.l., with headquarters in Via Vittorio Lombardi 14 - 36075 Montecchio Maggiore VI - Italy, hereby declares that the product

LNEEK... or LNEEX... or LNESK... or LNESX... or LNTEK... or LNTEX... or LNTSK... or LNTSX... electric pump with integrated variable speed drive (EXM type electric motor), with or without pressure transmitter(s) and associated cable(s) (see the label on the last page of "Safety and Other Information" manual)

fulfils the relevant provisions of the following European Directives

- Machinery 2006/42/EC and subsequent amendments (ANNEX II - natural or legal person authorised to compile the technical file: Xylem Service Italia S.r.l.)
- Eco-design 2009/125/EC and subsequent amendments, Regulation (EU) no. 547/2012 and subsequent amendments (water pump) if MEI marked.

and technical standards

- EN 809:1998+A1:2009, EN 60204-1:2018, EN 61800-5-1:2007+ A1:2017+A11:2021
- EN 16480:2021.

Additional information: the EXM series motor includes an integrated variable speed drive, and the energy performances of the two cannot be tested independently of each other (Regulation (EU) 2019/1781, Article 2(2)(b), (3)(a)). The marking shown (IE...-IES...) is that required by the technical standard IEC 61800-9-2.

Montecchio Maggiore, 23.03.2023

Peter Björnsson  
Managing Director

rev.00

### EU Declaration of Conformity (No 78)

1. RED - Radio equipment: LNEEK, LNEEX, LNESK, LNESX, LNTEK, LNTEX, LNTSK, LNTSX (see product data plate)  
RoHS - Unique identification of the EEE: LNE..K, LNE..X, LNT..K, LNT..X.
2. Name and address of the manufacturer:  
Xylem Service Italia S.r.l.  
Via Vittorio Lombardi 14  
36075 Montecchio Maggiore VI  
Italy
3. This declaration of conformity is issued under the sole responsibility of the manufacturer.
4. Object of the declaration:  
LNEEK... or LNEEX... or LNESK... or LNESX... or LNTEK... or LNTEX... or LNTSK... or LNTSX... electric pump with integrated variable speed drive (EXM type electric motor), with or without pressure transmitter(s) and associated cable(s).

5. The object of the declaration described above is in conformity with the relevant Union harmonization legislation:
  - Directive 2014/53/EU of 16 April 2014 and subsequent amendments (radio equipment)
  - Directive 2011/65/EU of 8 June 2011 and subsequent amendments including Directive 2015/863/EU (restriction of the use of certain hazardous substances in electrical and electronic equipment)
6. References to the relevant harmonized standards used or references to the other technical specifications, in relation to which conformity is declared:
  - EN 61800-3:2004+A1:2012 (Category C2), EN IEC 61800-3:2018 (Category C2), EN 61000-6-2:2005, EN IEC 61000-6-2:2019, EN 61000-6-4:2007+A1:2011, EN IEC 61000-6-4:2019, EN 61000-3-2:2014, EN IEC 61000-3-2:2019+ A1:2021, EN 61000-3-3:2013+A1:2019+A2:2021, ETSI EN 300 328 V2.2.2 (2019-07), EN 62311:2008, EN IEC 62311:2020
  - EN IEC 63000:2018.
7. Notified body: - - -
8. RED - Any accessories/components/software: - - -
9. Additional information:  
RoHS - Annex III - Applications exempted from the restrictions: lead as a binding element in steel, aluminium and copper alloys [6(a), 6(b), 6(c)], in solders and in electrical/ electronic components [7(a), 7(c)-I].

Signed for and on behalf of:

Xylem Service Italia S.r.l.

Montecchio Maggiore, 23.03.2023

Peter Björnsson  
Managing Director

rev.00



Lowara is a trademark of Xylem Inc. or one of its subsidiaries.

Hydrovar is a trademark of Xylem Inc. or one of its subsidiaries.

Apple, Apple Logo, App Store and iPhone are trademarks of Apple Inc..

IOS® is a registered trademark of Cisco Systems, Inc. and/or its subsidiaries in the United States and in other countries, used by Apple Inc. under licence.

Google Play, Google Play logo and Android are trademarks of Google LLC.

## 11.2 UK Declaration of Conformity (Original)



Xylem Service Italia S.r.l., with headquarters in Via Vittorio Lombardi 14 - 36075 Montecchio Maggiore VI - Italy, hereby declares that the product:

LNEEK... or LNEEX... or LNESK... or LNESX... or LNTEK... or LNTEX... or LNTSK... or LNTSX... electric pump with integrated variable speed drive (EXM type electric motor), with or without pressure transmitter(s) and associated cable(s) (see the label on the last page of "Safety and Other Information" manual)

fulfils the relevant provisions of the following UK legal acts

- S.I. 2008/1597 - Supply of Machinery (Safety) Regulations 2008 and subsequent amendments (Schedule 2 - Part 2 - Annex II - natural or legal person authorised to compile the technical file: Xylem Service Italia S.r.l.)
- S.I. 2019/539 - The Ecodesign for Energy-Related Products and Energy Information (Amendment) (EU Exit) Regulations 2019 (water pump) if MEI marked,

and technical standards

- EN 809:1998+A1:2009, EN 60204-1:2018, EN 61800-5-1:2007+ A1:2017+A11:2021.
- EN 16480:2021

Additional information: the EXM series motor includes an integrated variable speed drive, and the energy performances of the two cannot be tested independently of each other (S.I. 2021/745, Regulation 34, Schedule 16, paragraphs 10(1)(b), 10(2)(a)). The marking shown (IE...-IES...) is that required by the technical standard IEC 61800-9-2.

Montecchio Maggiore, 23.03.2023

Peter Björnsson  
Managing Director

rev.00



#### UK Declaration of Conformity (No 78)

10. RED - Radio equipment: LNEEK, LNEEX, LNESK, LNESX, LNTEK, LNTEX, LNTSK, LNTSX (see product data plate)  
RoHS - Unique identification of the EEE: LNE..K, LNE..X, LNT..K, LNT..X.
1. Name and address of the manufacturer:  
Xylem Service Italia S.r.l.  
Via Vittorio Lombardi 14  
36075 Montecchio Maggiore VI  
Italy
  2. This declaration of conformity is issued under the sole responsibility of the manufacturer.
  3. Object of the declaration:  
LNEEK... or LNEEX... or LNESK... or LNESX... or LNTEK... or LNTEX... or LNTSK... or LNTSX...  
electric pump with integrated variable speed drive (EXM type electric motor), with or without pressure transmitter(s) and associated cable(s).
  4. The object of the declaration described above is in conformity with the relevant UK legislative acts:
    - S.I. 2017/1206 - The Radio Equipment Regulations 2017 and subsequent amendments).
    - S.I. 2012/3032 - The Restriction of the Use of Certain Hazardous Substances in Electrical and Electronic Equipment Regulations 2012 and subsequent amendments).
  5. References to the relevant designated standards used or references to the other technical specifications, in relation to which conformity is declared:
    - EN 61800-3:2004+A1:2012 (Category C2), EN IEC 61800-3:2018 (Category C2), EN 61000-6-2:2005, EN IEC 61000-6-2:2019, EN 61000-6-4:2007+A1:2011, EN IEC 61000-6-4:2019, EN 61000-3-2:2014, EN IEC 61000-3-2:2019+ A1:2021, EN 61000-3-3:2013+A1:2019+A2:2021, ETSI EN 300 328 V2.2.2 (2019-07), EN 62311:2008, EN IEC 62311:2020
    - EN IEC 63000:2018.
  6. Approved body: - - -
  7. RE-D - Any accessories/components/software: - - -
  8. Additional information:  
RoHS - Annex III of Directive 2011/65/EU - Applications exempted from the restrictions: lead as a binding element in steel, aluminium and copper alloys [6(a), 6(b), 6(c)], in solders and in electrical/ electronic components [7(a), 7(c)-I].

Signed for and on behalf of:  
Xylem Service Italia S.r.l.

Montecchio Maggiore, 23.03.2023

Peter Björnsson  
Managing Director

rev.00



Lowara is a trademark of Xylem Inc. or one of its subsidiaries.

Hydrovar is a trademark of Xylem Inc. or one of its subsidiaries.

Apple, Apple Logo, App Store and iPhone are trademarks of Apple Inc..

IOS® is a registered trademark of Cisco Systems, Inc. and/or its subsidiaries in the United States and in other countries, used by Apple Inc. under licence.

Google Play, Google Play logo and Android are trademarks of Google LLC.

# 12 Warranty

For information on the warranty refer to the commercial documentation.





# Xylem |'zīləm|

- 1) The tissue in plants that brings water upward from the roots;
- 2) A leading global water technology company.

We're a global team unified in a common purpose: creating innovative solutions to meet our world's water needs. Developing new technologies that will improve the way water is used, conserved, and re-used in the future is central to our work. We move, treat, analyze, and return water to the environment, and we help people use water efficiently, in their homes, buildings, factories and farms. In more than 150 countries, we have strong, long-standing relationships with customers who know us for our powerful combination of leading product brands and applications expertise, backed by a legacy of innovation.

**For more information on how Xylem can help you, go to [www.xylem.com](http://www.xylem.com)**



Xylem Service Italia S.r.l.  
Via Vittorio Lombardi 14  
36075 - Montecchio Maggiore (VI) - Italy  
[xylem.com/lowara](http://xylem.com/lowara)

Lowara is a trademark of Xylem Inc. or one of its subsidiaries.  
© 2024 Xylem, Inc. Cod. 001088083EN rev.A ed.02/2024